

SKETCH MAP TO SHOW APPROXIMATE POSITIONS OF SOUTH MAGNETIC POLE.

- A. "Discovery" Expedition.
- B. Lieut. SHACKLETON'S Expedition.
- C. "Southern Cross" Expedition.

NATIONAL ANTARCTIC EXPEDITION

1901-1904

---

---

MAGNETIC OBSERVATIONS

---

---

PREPARED UNDER THE SUPERINTENDENCE OF THE ROYAL SOCIETY

---

---

LONDON:

PUBLISHED BY THE ROYAL SOCIETY

---

1909

100-1000000

CONTENTS.

	Page
Preface, by Sir A. GEIKIE, K.C.B., Pres. R.S. . . . .	vii
Introductory Note, by L. C. BERNACCHI . . . . .	1
Historical Note, by Dr. C. CHREE, F.R.S. . . . .	5
Explanation of Tables of Hourly Values . . . . .	7
Tables of Hourly Values . . . . .	8
Table of Days made use of for Diurnal Inequalities . . . . .	71

DISCUSSION OF THE OBSERVATIONS, BY DR. C. CHREE, F.R.S.

CHAPTER I.

INSTRUMENTS AND RECORDS.

Sections	Page
1-5. Instruments . . . . .	73
6, 7. Scale Values of Curves . . . . .	75
8, 9. Temperature Coefficient of Vertical-Force Magnet . . . . .	76

CHAPTER II.

BASE-LINE VALUES. ANNUAL INEQUALITY. SECULAR CHANGE.

10, 11. Declination and Horizontal-Force Base-Line Values . . . . .	78
12, 13. " " " Mean Monthly Values . . . . .	80
14. " " " Secular Change . . . . .	81
15, 16. " " " Annual Inequality . . . . .	81
17-19. Vertical-Force Base-Line Values and Temperature Corrections . . . . .	83

CHAPTER III.

DIURNAL INEQUALITIES AND THEIR DISCUSSION.

20-22. Diurnal Inequalities of Declination, Horizontal Force and Vertical Force . . . . .	87
23-24. Explanation of Diurnal-Inequality Tables and Curves . . . . .	89
Diurnal-Inequality Tables XII-XXII . . . . .	90
25. Non-Cyclic Changes . . . . .	100
26-28. Discussion of Declination, Horizontal Force, and Vertical-Force Inequalities . . . . .	101
29. Diurnal Inequality of Inclination . . . . .	102
30. " " South and West Components . . . . .	103
Figures 1-13, illustrating Diurnal Inequalities . . . . .	104

CHAPTER IV.

DIURNAL INEQUALITIES. FOURIER COEFFICIENTS.

31, 32. Fourier <i>a</i> and <i>b</i> Coefficients . . . . .	117
33-35. " <i>c</i> and <i>α</i> Coefficients . . . . .	121

CHAPTER V.

Sections		Page
36, 37.	ANNUAL VARIATION. FOURIER COEFFICIENTS . . . . .	129

CHAPTER VI.

ABSOLUTE DAILY RANGES. DAILY MAXIMA AND MINIMA.

38-43.	Absolute Daily Ranges of Declination, Horizontal Force and Vertical Force . . . . .	131
44, 45.	Incidence of Daily Maxima and Minima . . . . .	138

CHAPTER VII.

TERM-HOUR AND SPECIAL RECORDS.

46, 47.	Term-Hour Records from Mauritius . . . . .	146
48.	"          "          Christchurch . . . . .	147
49-51.	"          "          Antarctic Winter Quarters . . . . .	148
52.	Antarctic Record during Solar Eclipse . . . . .	151
53.	Pulsations . . . . .	151
54.	Antarctic Record on exceptionally Quiet Day . . . . .	152

CHAPTER VIII.

RECORDS OF DISTURBANCES FROM CO-OPERATING STATIONS AND WINTER QUARTERS.

55-62.	Comparative Records from Falmouth, Colaba, Mauritius, and Christchurch . . . . .	153
63-76.	Antarctic Records of Disturbances . . . . .	158
77-84.	Various Representative Types of Antarctic Disturbances . . . . .	166

CHAPTER IX.

MATHEMATICAL ANALYSIS OF DISTURBANCES, AND THEIR DISCUSSION.

85.	General Discussion of Theories . . . . .	170
86-88.	Case of Sphere of Magnetic Material in a Uniform Field . . . . .	170
89, 90.	Definition and Nature of Disturbances . . . . .	173
91-101.	Analysis of Selected Disturbances recorded at the Co-operating Stations and at Winter Quarters . . . . .	175

CHAPTER X.

102-108.	Special Type of Disturbance . . . . .	186
----------	---------------------------------------	-----

CHAPTER XI.

109-114.	Comparison of Antarctic Magnetic Disturbances and Aurora . . . . .	193
----------	--	-----

APPENDIX A.

Christchurch Term-Day Observations . . . . .	201
--	-----

APPENDIX B.

An Examination of Antarctic Disturbances from October, 1902, to March, 1903, which are simultaneous with Arctic Disturbances discussed by Prof. KR. BIRKELAND . . . . .	246
---	-----

## ILLUSTRATIONS.

Map of South Victoria Land (frontispiece).

Sketch of magnetographs as mounted (p. 3).

Figs. 1-13. Declination and other curves and diagrams (pp. 104-116).

Plates (at end of volume)—

- |       |  |
|-------|--|
| Plate | I.—Term Hours, quick run, at Mauritius.  |
| „     | II.— „ „ slow run, at Mauritius.   |
| „     | III.— „ „ June 15, and July 1, 1902, at Christchurch.                          |
| „     | IV.— „ Hour, June 15, 1902, at Winter Quarters.                                |
| „     | V.— „ „ July 1, 1902, at Winter Quarters.                                      |
| „     | VI.— „ Hours, April 1 and 15, and June 1, 1902, at Winter Quarters.            |
| „     | VII.— „ „ July 15, and August 1 and 15, 1902, at Winter Quarters.              |
| „     | VIII.— „ „ September 1 and 15, and October 1 and 15, 1902, at Winter Quarters. |
| „     | IX.— „ „ November 1 and 15, and December 1 and 15, 1902, at Winter Quarters.   |
| „     | X.— „ „ January 1 and 15, and February 1 and 15, 1903, at Winter Quarters.     |
| „     | XI.—Record during Solar Eclipse at Winter Quarters (September 21, 1903).       |
| „     | XII.—“Pulsations” (February 2, 1903).  |
| „     | XIII.—Record during especially Quiet Day (June 27 and 28, 1903).               |
| „     | XIV.—Disturbance of May 8, 1902, at Co-operating Stations.                     |
| „     | XV.— „ „ August 20, and November 6 and 24, 1902, at Co-operating Stations.     |
| „     | XVI.— „ „ April 5 and 6, 1903, at Co-operating Stations.                       |
| „     | XVII.— „ „ June 19, and July 26, 1903, at Christchurch.                        |
| „     | XVIII.— „ „ August 22, 1903, at Christchurch.                                  |
| „     | XIX.— „ „ August 25 and 26, 1903, at Co-operating Stations.                    |
| „     | XX.— „ „ December 13, 1903, at Falmouth.                                       |
| „     | XXI.— „ „ December 13, 1903, at Colaba and Mauritius.                          |
| „     | XXII.— „ „ May 8 and 9, 1902, at Winter Quarters.                              |
| „     | XXIII.— „ „ August 21, 1902, at Winter Quarters.                               |
| „     | XXIV.— „ „ November 7, 1902, at Winter Quarters.                               |
| „     | XXV.— „ „ November 24, 1902, at Winter Quarters.                               |
| „     | XXVI.— „ „ April 6, 1903, at Winter Quarters.                                  |
| „     | XXVII.— „ „ June 19, 1903, at Winter Quarters.                                 |
| „     | XXVIII.— „ „ June 28, 1903, at Winter Quarters.                                |
| „     | XXIX.— „ „ June 29, 1903, at Winter Quarters.                                  |
| „     | XXX.— „ „ July 26, 1903, at Winter Quarters.                                   |
| „     | XXXI.— „ „ August 17, 1903, at Winter Quarters.                                |
| „     | XXXII.— „ „ August 22 and 23, 1903, at Winter Quarters.                        |
| „     | XXXIII.— „ „ August 26, 1903, at Winter Quarters.                              |
| „     | XXXIV.— „ „ August 26, 1903, at Winter Quarters.                               |
| „     | XXXV.— „ „ October 12 and 13, 1903, at Winter Quarters.                        |
| „     | XXXVI.— „ „ December 13 and 14, 1903, at Winter Quarters.                      |

Plates XXXVII to XLIII.—Representatives of different Types of Disturbance at Winter Quarters.





## PREFACE.

THE volume of "Physical Observations" of the National Antarctic Expedition, 1901-1904, under Captain R. F. SCOTT, R.N., which was published in the summer of 1908, included a report on one portion of the Magnetic work. This Report consisted mainly of a reduction of the absolute and relative observations by Commander L. W. P. CHETWYND, R.N. It contained, also, an account by Mr. BERNACCHI of the Observatory site in McMurdo Sound, of the geological features of the district, of the instruments employed, and of other matters, likewise Tables of the Hourly Values of Declination, Horizontal Force and Vertical Force on term-days at different observatories during 1902-1903, and a report by Mr. R. C. MOSSMAN and Dr. CHREE on the Magnetic Observations of the "Scotia," under Dr. W. S. BRUCE.

The present volume, with its detailed Tables of Hourly Values and its exhaustive discussion of the Observations, completes the presentation of the Magnetic work of the "Discovery." The Royal Society, in arranging for this investigation, was fortunate, with the sanction and co-operation of Dr. GLAZEBROOK, F.R.S., Director of the National Physical Laboratory, in obtaining the invaluable services of Dr. CHARLES CHREE, F.R.S., of the Kew Observatory. His pre-eminent qualifications for the onerous task imposed upon him, and the unwearied zeal with which he has prosecuted it to the end, give to this portion of the Reports of the Expedition a special scientific interest and importance.

Dr. CHREE has mentioned in his Historical Note (p. 5) the various Institutions and individuals who have contributed their services towards the preparation of the materials of this volume. To all of them the thanks of the Royal Society are due. Special allusion, however, should here be made to the assistance generously given by Mr. BERNACCHI, who was in charge of the Magnetographs of the Expedition. Not only has he taken a large share in the tabulation of the magnetic curves, but he has been always ready to help during the preparation of this Report. A reference is also called for to the great zeal with which, as Dr. CHREE has heartily acknowledged, the successive Directors of the Christchurch Observatory, New Zealand, Dr. COLERIDGE FARR and Mr. H. F. SKEY, entered into the co-operative scheme of observations suggested by the Royal Society, and to the interest and importance of the information which they were so good as to transmit. Magnetic Stations in the Southern Hemisphere are so few in number that it was particularly useful to obtain so ample a record of observations from Christchurch, which is the nearest observatory to the Antarctic Winter Quarters of the "Discovery."

From the map, which forms the frontispiece, it will be seen how closely the positions agree which have been assigned by three successive recent expeditions to the South Magnetic Pole. The position found by the "Southern Cross" was about Lat.  $72^{\circ} 40' S.$ , Long.  $152^{\circ} 30' E.$  That obtained from the observations of the "Discovery" was Lat.  $72^{\circ} 51' S.$ , Long.  $156^{\circ} 25' E.$  ("Physical Observations" of National Antarctic Expedition, 1908, p. 156). Lieutenant SHACKLETON has been so good as to furnish the exact position found by him, which is Lat.  $72^{\circ} 25' S.$ , Long.  $155^{\circ} 16' E.$

ARCH. GEIKIE.

Royal Society, Burlington House,  
27th September, 1909.



## INTRODUCTORY NOTE.

BY

L. C. BERNACCHI, F.R.G.S.

THE self-recording Magnetographs supplied to the National Antarctic Expedition were of the delicate transportable type devised by the late Professor VON ESCHENHAGEN and made by the firm of O. TOEPFER, of Potsdam, Germany. They were received at the National Physical Laboratory, Surrey, England, in August, 1901, after the departure of the "Discovery."

The set consisted of three instruments, viz., a Declinometer, a Horizontal-Force Magnetometer, and a Vertical-Force Magnetometer, with a self-recording photographic apparatus. No instructions were supplied by the makers, and as they were of a type absolutely strange in this country, some little difficulty was at first experienced in erecting and adjusting the instruments.

Dr. HARKER and Mr. F. E. SMITH, of the National Physical Laboratory, succeeded in adjusting them satisfactorily, and had them recording for a few days before my departure from England by mail boat to join the "Discovery" in New Zealand.

The Horizontal-Force instrument proved to be considerably more sensitive than the Kew form of differential magnetometers—a difference which was due to the fineness of the quartz suspension fibre employed. Unfortunately, it was not discovered until too late that the boxes of spare quartz-fibres supplied contained even finer threads than that already in the instrument.

On arriving at Melbourne, at the end of October, 1901, the instruments were taken to the Government Observatory and erected on a wood bench in a cellar. From November 1st to November 10th they worked in a satisfactory manner. They were subsequently conveyed to the "Discovery" at Lyttelton, New Zealand, carefully secured in my cabin, and were not again removed until the ship reached her Winter Quarters in McMurdo Sound in February of 1902.

*Winter Quarters.*—The Winter Quarters were situated in latitude  $77^{\circ} 50' 50''$  S., longitude  $166^{\circ} 44' 45''$  E. of Greenwich, and to the south of a narrow peninsula extending in a south-west direction from the base of an island formed by Mounts Erebus and Terror. The "Discovery" remained frozen-up in her Winter Quarters from February, 1902, until February, 1904.

*Observatory Site.*—The spot selected for the Observatory, although the best available, was hardly an ideal one for magnetic observations. From a magnetic point of view, an observatory of this kind should be placed in a position undisturbed by the presence of magnetic rocks; but it would be difficult to find such an undisturbed locality in Victoria Land, unless it were on the surface and near the seaward edge of one of the extensive ice-floes, far from the actual coast line, such as the Great Ice Barrier.

*Geological Formation.*—A description of the Geological Formation in the neighbourhood of the station will be found in "Physical Observations," pp. 129–130.

*Observations for Local Attraction.*—A comparison of the results of absolute observations made in the Magnetic Hut with some taken on the ice in McMurdo Sound at a considerable distance from land will be found in "Physical Observations," p. 134.

The site selected for the houses was a low and fairly level piece of rocky ground close to the extremity of the peninsula, and at a distance of about 300 yards from the ship (*see* Frontispiece). The peninsula is about 10 miles long by a mile broad, and has an average height of 600 to 700 feet, although the extremity where the Observatories were placed was only 30 feet above the mean sea level.

*Observation Houses.*—The Observation Houses were constructed of large asbestos slates, screwed on to the outside and inside of a wood framework. The larger of the two used for the Variation House was 11 feet 6 inches by 11 feet 6 inches, and 6 feet 8 inches high.

Although, perhaps, small log houses would have been more suitable, they certainly would not have

been so light, compact, and easily portable. The asbestos houses were fairly satisfactory, but had some disadvantages.

*Installation.*—The instruments were erected on a strong firm wood bench (*see* p. 3), 8 feet 5 inches in length and 1 foot 6 inches in breadth, and supported at one end by a drain pipe, 1·6 feet in diameter, sunk into the frozen ground, and at the other end by a thick pillar of wood sunk in the same manner. The thickness of the wood slab forming the bench was 3 inches, and it was 2·6 feet above the floor of the house. The bench was carefully erected in the magnetic Meridian, the magnetometer and Declination magnet being used for finding the Meridian, and the instruments fixed upon it in the following order :—

Magnetic North (S.S.E. true) extremity the recording cylinder and clock apparatus, nearest the cylinder the declinometer, then the Horizontal-Force instrument, and at the magnetic South extremity the Vertical-Force instrument.

The suspension fibre of the declinometer was the original one employed at Kew; it was used throughout the two years and returned to England with the instrument.

On examining the Horizontal-Force fibre originally supplied with the instrument it was found to be broken; this unfortunately happened to be the stoutest fibre supplied, and it became necessary to replace it by a succession of fibres which gave the magnet an unnecessary and rather troublesome degree of sensitiveness.

The magnets for the declinometer and Horizontal-Force instrument consist of well-hardened laminar pieces of watch-spring steel, 25 mm. in length and weighing about 1·5 gramme. A light aluminium frame supports the mirror and the magnet, and this is hung by means of a double hook on a small cross-piece attached to the bottom of the quartz-fibre suspension.

The Vertical-Force instrument is a modification of the Lloyd balance, and as it was only completed shortly before leaving England, very little was known of its behaviour even at Potsdam. This instrument was a source of constant trouble. The needle was balanced for a dip of about 70° N. The magnetic dip at Winter Quarters being nearly 85° S., the pull on the S. end of the needle could not be overcome by the small weights and auxiliary magnets supplied for the purpose, and therefore additional weights had to be added to the N. end, which increased the temperature coefficient of the balance.

The chief feature of the recording apparatus is that all three elements, base lines, and a temperature curve are on the same photogram for the day. On disturbed days—and they were frequent—and in the Summer when the movements of the magnets are large the result was a considerable confusion of the curves.

From May, 1902, until January, 1904, the declinometer was never interfered with, to the knowledge of the observer, nor its zero mirror altered.

During the first year the Horizontal-Force instrument was two or three times found to be out of adjustment and altered, but remained untouched after April 1, 1903, while the Vertical-Force instrument was altered from time to time during both years. The method of determining sensitiveness was by deflecting the suspended magnets with one of the unifilar collimating magnets at certain known distances, and then carefully finding the moment of the deflecting magnet by a set of absolute observations.

*Routine.*—The general routine was usually as follows :—The Observatory was entered at between 11 a.m. and noon each day, the light-shutter of the magnetograph closed, and the time of doing so noted by means of a chronometer watch. The thermometer inserted in the Vertical-Force instrument was then read.

After changing the paper on the recording cylinder, filling and trimming the lamps, the thermometer was again read, the light-shutter dropped, and the time of doing so noted as before by means of the chronometer. The whole operation occupied about 30 minutes, and times of stopping, starting, temperatures, and error of watch on mean time were entered in a note book.

*Temperature of House.*—During the first year the walls only of the Variation House were banked with snow, and a large brass heating lamp was kept burning within, so as to maintain as uniform a temperature as possible. This lamp was frequently a source of danger and inconvenience of an aggravating nature, and required constant watching. Unless there was a draught underneath the lamp it emitted dense smoke which on calm days filled the room and extinguished the small oil lamp which provided the beam of

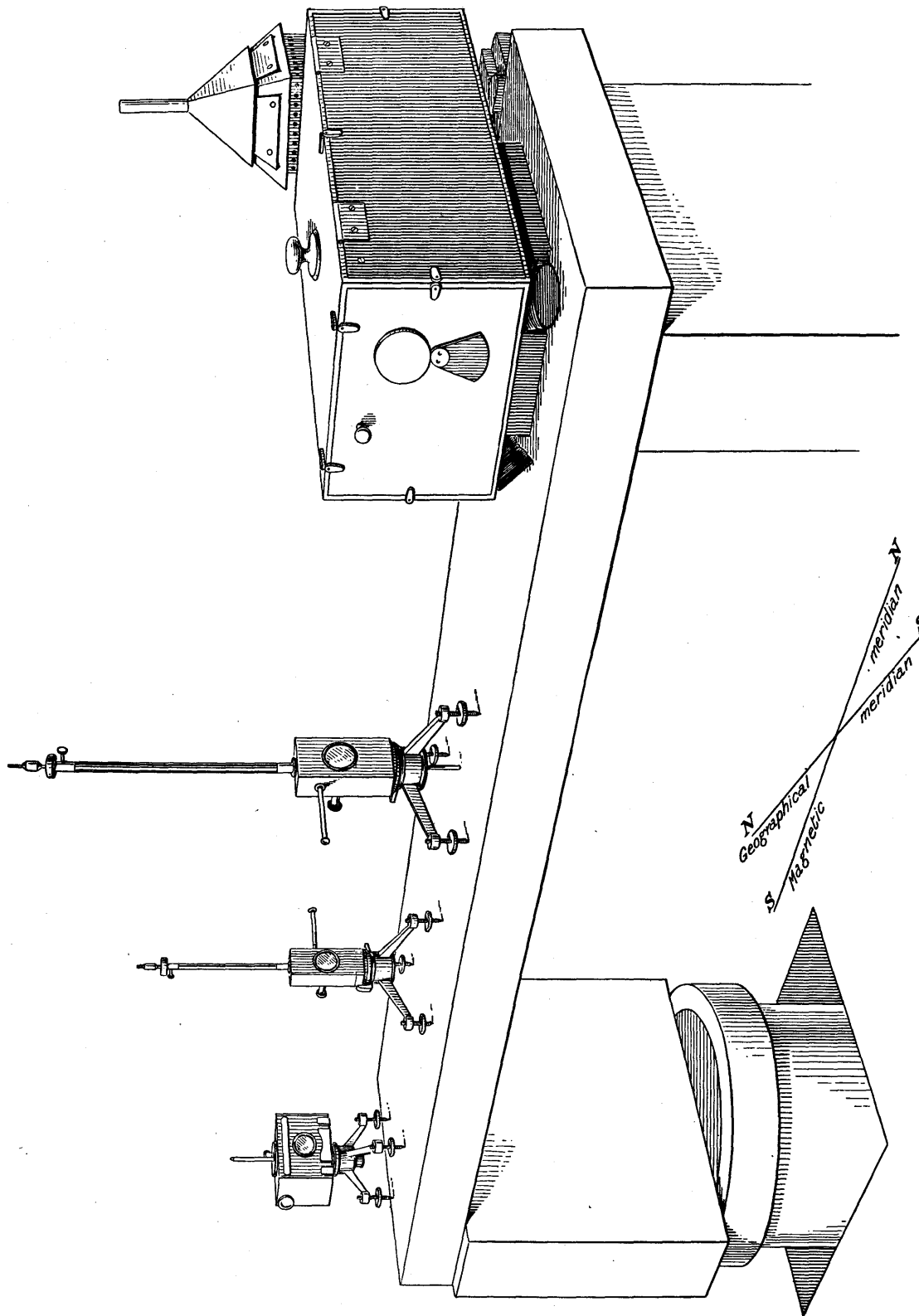

View of Magnetographs as mounted.

light for the sensitive paper on the recording drum. This accounts for the loss of a few days' records during the first year. Nor was the lamp successful in keeping a uniform temperature and giving out a fair proportion of heat for the amount of oil burned. During the second year the lamp was dispensed with, and the house was entirely buried under snow, and although at times the temperature within was low, viz. : - 30° F., its diurnal variation was seldom large throughout the 24 hours.

*General.*—During the first year the curves are finer and sharper than during the second, on account of a more sensitive bromide paper being employed, and, consequently, a smaller light-slit. The magnetograms were usually developed once a week by means of ortol-soda developer, which has the advantage of being exceptionally clean to use and gives rich dark tones to the curves.

Towards the end of the second year the supply of recording paper became very short, and from the end of September, 1903, had to be distributed equally over the subsequent months, amounting to about 4 days in each month. This is the only serious break in the two years' record. In all there are records for about 600 days.

My thanks are due to the New Zealand Government for the courtesy in placing the Christchurch Observatory at our disposal, to Dr. COLERIDGE FARR and Mr. H. F. SKEY, of that Observatory, for their valuable assistance, to Mr. P. BARACCHI, Government Astronomer of Victoria, and to Dr. CHARLES CHREE, F.R.S., who has been so closely associated with the "Discovery" magnetic work from the beginning.

## HISTORICAL NOTE.

BY

DR. CHARLES CHREE, F.R.S.

THE tabulation of the Magnetic Curves registered at the Winter Quarters of the National Antarctic Expedition between March, 1902, and January, 1904, was commenced in the Observatory Department of the National Physical Laboratory in December, 1904. The material consisted of photographic records of Magnetic Declination, Horizontal Force and Vertical Force for some 600 days. For the first six months the work was carried out by Mr. L. C. BERNACCHI, who had been in charge of the magnetographs of the Antarctic Expedition. He went carefully through the curves, and decided the exact times of starting and stopping registration on each day by reference to the daily notes he had made in the observation books and the register of watch- and chronometer-rates. He also tabulated, with the assistance of Mr. B. JOHNSON, a large portion of the records of Magnetic Declination. On Mr. BERNACCHI'S relinquishing the work it was entrusted to Mr. H. A. MAUDLING, who carried it on, with Mr. JOHNSON'S assistance, until he left for another post in the summer of 1906. He was succeeded by Mr. A. E. GENDLE, who continued the work until his appointment, early in 1908, to Eskdalemuir Observatory. The completion of the work was then entrusted to Mr. B. FRANCIS, Librarian in the Observatory Department, who, with the assistance of Mr. F. LEVIN, brought it to a conclusion.

In addition to the tabulating work, the assistants mentioned carried out a great deal of arithmetical work, in connection more especially with the tables of Diurnal Inequalities and the calculation of Fourier Coefficients. Whilst the repeated changes in the personnel tended to delay the work, and interfered, possibly, to some extent with its continuity, there was the compensating advantage that the checking of the measurements almost invariably fell to a new and unprejudiced observer. The fact that under these circumstances few serious mistakes were discovered encourages the belief that a high standard of accuracy was maintained. During 1908 a good deal of photographic work in connection with the reproduction of the Antarctic curves was done by Mr. W. J. BOXALL, a senior assistant in the Observatory Department, and a good many other curves were copied with the Schmidt tracer at Bushy House, by Mr. W. H. BROOKES, under the supervision of Mr. F. J. SELBY.

My work has been much facilitated by the care exercised by all these gentlemen. To Mr. BERNACCHI I am particularly indebted for the trouble which he has taken throughout the whole course of the work in assisting in the removal of sources of uncertainty on which he alone could throw any direct light.

Thanks are also due to Dr. COLERIDGE FARR and Mr. H. F. SKEY, successive Directors of Christchurch Observatory, New Zealand, to Mr. C. T. F. CLAXTON, Director of the Royal Alfred Observatory, Mauritius, to Mr. N. A. F. MOOS, Director of the Colaba Observatory, Bombay, and to Mr. E. KITTO, Superintendent of Falmouth Observatory. In response to an appeal issued by the Royal Society's Antarctic Magnetic Committee, these gentlemen put at my disposal, in the most generous way, copies or originals of the records of a number of magnetic disturbances, synchronous with disturbances recorded at the Antarctic Winter Quarters. The extent to which the work has benefited by the co-operation of these gentlemen will be appreciated only after a study of Chapters VIII and IX. Valuable as was the contribution of copies of disturbed curves from Christchurch Observatory—the nearest observatory in existence to Winter Quarters—it represents but a small part of what has been done by Dr. FARR and Mr. SKEY. In his anxiety to utilise to the full the opportunities presented by the Antarctic Expedition, Dr. FARR extended the scheme of co-operation arranged with the German Antarctic Expedition and co-operating Observatories, to the extent of running the Christchurch magnetographs at high speed during the whole 24 hours of the two monthly "term" days, so as to secure a very open time scale. Mr. SKEY had all these quick-run curves tabulated at 1-minute intervals and part at 20-second intervals, and the results of all these measurements were sent to this country, along with photographic copies of the



original curves. The measurements were received by the Hydrographic Department of the Admiralty—who had undertaken the “term” day observations along with the absolute observations—only a short time before the printing of the volume of “Physical Observations” was completed. Under these circumstances the Hydrographer and Captain CHETWYND agreed that the material had better be handed over to me, to be discussed in the present volume. The discussion will be found in Appendix A.

In view of the absence of reference in the text to the recently published ‘The Norwegian Aurora Polaris Expedition, 1902–1903,’ vol. 1, of Professor KR. BIRKELAND, I should explain that Professor BIRKELAND’S volume did not appear until the present work had been practically completed. The disturbed curves had been selected and copies had been made and sent to the engraver, and all the mathematical calculations of Chapters IX and X had been carried out and the discussion written. The preparation of the present volume had already taken much longer time than was originally anticipated, and to have deferred the printing, pending an examination of Professor BIRKELAND’S large volume, did not appear advisable.

The text has thus been left unaltered, and any conclusions or theoretical views which it may contain are absolutely independent of any similar or conflicting results which Professor BIRKELAND has reached.

On studying Professor BIRKELAND’S volume, however, I found that almost all the disturbances which he had selected for discussion were represented in the Antarctic. The opportunity for comparing Arctic and Antarctic results appeared so unique that it was decided that a special Appendix, B, should be written dealing with the subject. It is hoped that the interest attaching to the results will be deemed sufficient justification for the three or four months’ delay which the preparation of the Appendix has entailed in the appearance of the present volume.

My part of the work has had to be carried out with due regard to the claims of official duties, which at times leave very little unoccupied leisure.

A great many difficulties had to be dealt with, some of them calling for very delicate discrimination. Under these circumstances the ordinary tendency of humanity to err is pretty certain to have asserted itself, but, at all events, no pains have been spared to aim at that measure of accuracy which it is given to erring mortals to secure.

Observatory Department of the  
National Physical Laboratory,  
Richmond, Surrey,

*July, 1909.*

## EXPLANATION OF TABLES OF HOURLY VALUES.

Pages 8 to 70 contain tables giving the hourly values of Declination, Horizontal Force and Vertical Force at Winter Quarters (lat.  $77^{\circ} 50' 50''$  S., long.  $166^{\circ} 44' 45''$  E.). The way in which these values were arrived at is explained later (*see* Chap. III., § 20).

As a rule, each page contains data for a single month for one of the elements, but November and December, 1903, and January, 1904, contained so few days of registration that a single page sufficed for these three months. The time shown in these tables is local mean time, which was 11h. 7m. fast on Greenwich. As is usual in magnetic tables, there appears at the top of the Declination tables a value in degrees common to all the hourly values, and at the top of the Horizontal- and Vertical-Force tables the commencing figures or figure of the values expressed in C.G.S. units. For instance, the March, 1902, Declination table is headed  $D=151^{\circ} +$ , and the value entered under 1 a.m. of the 2nd is  $118' \cdot 1$ . This means a Declination of  $151^{\circ} + 118' \cdot 1$ , or  $152^{\circ} 58' \cdot 1$ , at the hour stated. Owing to the large size of the daily range of Declination, it was impossible to avoid entries exceeding  $60'$ .

The last four columns give the absolutely highest and lowest values of the element shown on the day's trace, and the time or times of their occurrence. Thus on March 2, 1902, the absolutely largest or maximum reading on the Declination trace was  $151^{\circ} + 179' \cdot 6$ , *i.e.*  $153^{\circ} 59' \cdot 6$ , and its hour of occurrence was 6h. 7m. in the morning, local time.

In the case of the Vertical Force, information as to maxima and minima is confined to days when the photographic record was complete except for the interval occupied in changing the papers.

In general the cause of absence of hourly readings is indicated in the tables, the letters  $a, a', b, c, d$ , being employed for brevity with the following meanings:—

- $a$  no trace of the element, usually from no paper being on the drum;
- $a'$  (in case of Vertical Force) no temperature trace;
- $b$  (special case of  $a$ ) a gap between successive sheets which could not be filled in satisfactorily;
- $c$  trace existent, but either too faint or too confused to tabulate;
- $d$  instrument recording, but not working satisfactorily.

When the magnetograph in question was working, but the trace was beyond the limits of registration, the fact is indicated by inserting the value answering to the extreme limit of registration, followed by a plus or a minus sign according to circumstances. For instance, in December, 1902, the Declination is given in the table as  $(150^{\circ} +) 326' \cdot 0 +$  at 6.5 a.m. on the 2nd, and as  $(150^{\circ} +) 30' \cdot 5 -$  at 8.10 a.m. on the 10th. This means that on the former occasion the Declination was beyond the limit  $(150^{\circ} +) 326' \cdot 0$  of possible registration in the direction of high Declination, while on the latter occasion it was beyond the limit  $(150^{\circ} +) 30' \cdot 5$  of possible registration in the direction of low Declination. This explanation applies both to maxima and minima and to hourly values.

In the case of Declination and Vertical Force the trace was registered right up to either edge of the sheet. In the case, however, of Horizontal Force the light from the lamp began to be eclipsed whilst the trace was still considerably short of that edge of the sheet which answered to low values of the force, and the trace became fainter and fainter, eventually vanishing at a distance from the edge which varied sensibly with the brightness of the lamp and the development of the photographic paper.

The most usual time to change papers was within an hour or two of noon, so that a day's trace appeared usually on two different sheets (sometimes on more, when there were quick runs).

In the case of the Vertical Force there was the complication that the edge of the sheet had a constantly varying value unless temperature were absolutely steady. When Declination or Horizontal Force was highly disturbed, the trace might be repeatedly off and on in the course of an hour. The most appropriate entry in these cases was only decided after investigation of the special features. That absolute consistency prevailed in the treatment is hardly likely, but uniformity was aimed at, so far as possible (*see* Chap. III).



DECLINATION, APRIL, 1902.

Day.	Midt.	D = 151° +																								Maximum reading and time.	Minimum reading and time.				
		Forenoon.												Noon.	Afternoon.													Midt.			
		0.	1.	2.	3.	4.	5.	6.	7.	8.	9.	10.	11.	12.	1.	2.	3.	4.	5.	6.	7.	8.	9.	10.	11.				12.		
1	a	a	a	a	a	a	a	a	a	a	a	a	a	a	151.1	122.4	117.3	95.6	83.7	51.0	104.1	86.3	108.2	118.8	143.7	165.0	11.51 p.m.	51.0	6.40 p.m.		
2	143.7	135.3	131.7	135.1	135.4	140.6	135.3	151.1	162.5	166.8	170.0	151.7	146.0	134.3	117.0	115.8	112.5	117.9	120.0	118.0	117.5	129.3	130.5	128.5	126.0	184.5	8.42 a.m.	108.0	4.4	''	
3	126.0	134.6	133.1	132.0	134.0	136.5	143.6	148.5	148.5	142.5	136.5	128.6	141.0	117.5	104.0	83.6	96.0	99.5	104.6	102.5	113.0	105.6	122.0	117.0	120.5	159.9	9.28	''	71.7	3.6	''
4	120.5	137.0	139.1	138.0	134.6	145.1	179.6	185.0	176.0	161.0	133.1	144.5	137.2	128.7	125.3	131.0	124.8	113.1	117.8	113.3	122.6	125.0	113.6	128.3	133.7	206.4	8.5	''	101.6	5.44	''
5	133.7	129.6	139.1	149.0	142.5	146.6	153.8	145.4	160.5	165.8	140.3	135.8	122.3	125.0	118.5	115.5	117.5	118.5	122.0	126.5	126.5	125.0	132.0	135.0	132.5	219.0	8.28	''	106.5	5.34	''
6	132.5	130.5	134.6	142.1	140.0	146.6	150.0	150.5	149.6	148.5	151.5	127.5	123.0	121.1	117.5	122.0	120.5	120.0	126.0	118.5	123.0	124.5	124.1	125.6	130.1	175.5	9.41	''	114.0	4.18	''
7	130.1	132.5	134.6	148.5	147.5	145.1	147.5	140.6	145.5	149.6	148.5	133.1	128.0	127.5	124.1	120.0	118.1	121.1	123.9	126.0	132.5	130.1	133.1	132.5	135.5	165.0	9.50	''	100.5	4.34	''
8	135.5	133.5	133.5	145.1	143.0	150.5	151.1	142.5	142.5	150.5	149.6	159.5	134.0	129.9	125.9	122.0	120.5	128.6	126.5	123.5	122.0	106.5	119.0	123.0	128.0	172.5	10.45	''	90.0	9.8	''
9	128.0	129.0	138.5	147.0	142.5	143.6	151.1	148.5	156.5	158.6	158.6	167.0	161.6	148.8	141.0	125.6	124.1	117.5	115.1	95.0	95.6	125.0	132.0	133.5	138.5	201.0	11.6	''	63.5	7.32	''
10	138.5	145.5	144.5	142.5	142.1	139.5	142.1	163.1	164.6	177.0	184.5	177.5	154.1	137.7	133.5	133.1	133.1	133.1	136.5	135.5	138.0	135.0	136.5	139.1	131.6	196.5	10.25	''	124.1	11.57	''
11	131.6	156.5	127.5	144.5	156.0	153.5	136.5	138.0	132.0	132.8	c	c	c	c	c	c	c	11.0	61.1	0.0	3.0	9.4	32.0	74.6	139.1	175.5	1.15	''	0.0	7.8	''
12	139.1	176.3	155.3	141.5	182.6	206.6	165.0	166.5	154.5	174.0	173.6	158.0	174.5	173.0	151.5	148.5	139.5	111.0	109.1	140.0	150.5	152.6	160.5	156.5	166.1	225.8	8.52	''	90.0	5.43	''
13	166.1	163.5	163.1	164.0	161.0	164.0	163.1	163.5	163.1	162.0	169.5	181.1	180.1	165.0	157.5	154.1	153.3	145.5	150.0	147.0	146.6	147.5	141.5	161.0	153.0	189.0	11.35	''	126.0	10.20	''
14	153.0	149.6	163.1	159.5	164.6	166.5	176.0	172.1	162.0	202.1	176.0	176.0	176.0	161.0	156.0	148.1	141.0	134.0	144.0	137.0	152.6	156.0	156.0	156.0	162.0	225.0	9.15	''	117.0	6.37	''
15	162.0	161.6	162.0	162.0	166.1	167.6	172.1	172.1	173.0	175.5	171.5	173.0	166.2	161.0	152.0	141.4	144.5	144.2	138.4	137.8	141.4	140.0	136.7	140.3	141.8	188.0	8.47	''	129.5	6.23	''
16	141.8	144.1	147.5	146.0	145.7	147.5	147.7	150.1	146.6	155.5	157.6	156.5	151.7	151.1	b	143.5	141.5	143.0	140.5	141.5	a	a	a	a	a	164.8	10.55	''	137.8	6.12	''
17	a	a	a	a	a	a	a	a	a	a	a	a	a	a	181.6	148.6	135.5	132.8	134.0	137.5	135.1	135.5	146.0	145.6	145.0	201.5	1.48 p.m.	112.3	4.46	''	
18	145.0	148.0	147.1	150.1	150.1	151.0	151.6	154.6	147.1	160.6	149.0	150.5	159.5	167.0	148.6	143.0	134.0	135.5	132.1	140.5	143.0	142.6	135.1	140.0	139.6	177.8	0.45	''	123.5	5.40	''
19	139.6	148.0	146.0	150.1	151.6	151.6	160.6	157.0	159.5	162.5	165.5	159.1	149.0	143.0	142.0	140.0	140.0	137.5	139.6	133.0	132.1	125.5	132.5	141.5	148.0	172.3	9.59 a.m.	113.0	9.9	''	
20	148.0	147.5	144.5	150.1	153.1	152.0	162.0	154.6	158.5	160.6	143.5	160.6	156.5	152.7	148.6	141.1	143.0	141.5	125.5	127.0	128.5	119.0	90.5	94.6	109.0	186.8	8.36	''	68.5	10.55	''
21	109.0	178.0	138.1	157.0	171.1	167.0	163.0	168.5	181.0	184.6	179.5	164.0	171.5	148.0	143.0	132.5	118.0	8.0	108.5	150.5	140.5	143.0	139.6	150.1	137.5	221.0	5.52	''	8.0	5.0	''
22	137.5	148.0	144.5	144.1	163.0	192.1	167.5	172.6	183.1	168.1	188.0	154.6	142.8	154.0	139.6	139.6	130.0	138.5	128.0	115.0	123.1	134.0	135.5	144.5	152.5	225.5	7.48	''	104.0	7.0	''
23	152.5	145.0	147.1	152.5	153.5	164.0	162.1	155.5	178.6	165.1	163.6	160.6	151.7	153.1	140.5	146.0	147.5	144.5	144.5	145.0	143.0	144.1	142.6	151.6	145.0	191.0	10.26	''	128.0	1.7	a.m.
24	145.0	147.1	160.6	156.1	146.5	150.1	152.5	153.1	163.6	151.0	171.5	167.5	155.1	146.0	143.0	145.6	142.6	141.1	144.5	142.0	142.0	144.5	144.5	151.0	150.5	197.0	8.32	''	120.1	7.15	''
25	150.5	150.5	151.6	152.0	152.5	153.1	153.5	155.0	158.0	159.5	158.0	154.5	147.1	149.5	145.0	143.0	141.1	140.0	141.5	141.5	141.1	141.5	142.6	144.1	146.5	165.5	8.30	''	138.5	3.30	p.m.
26	146.5	146.5	145.6	145.6	146.5	146.0	146.5	150.1	150.1	154.0	154.6	155.0	152.3	140.2	139.1	138.1	133.9	134.9	133.9	134.3	131.8	135.1	136.7	139.3	139.9	161.0	11.35	''	123.5	8.4	''
27	139.9	138.1	141.2	140.5	139.0	136.4	137.5	139.7	144.2	142.7	144.5	143.0	144.5	145.3	144.5	145.6	146.5	146.2	145.6	145.6	147.4	148.6	148.6	148.6	150.7	150.5	11.49 p.m.	128.0	6.4	a.m.	
28	150.7	150.5	148.6	150.5	151.0	151.5	152.8	153.1	154.3	156.1	158.0	151.0	148.0	145.3	143.5	142.1	144.2	133.4	143.8	150.7	151.4	153.2	152.0	153.8	152.2	161.0	9.53 a.m.	111.1	5.9	p.m.	
29	152.2	152.3	151.6	153.1	a	a	a	a	a	a	a	a	155.2	150.4	153.2	150.4	149.0	150.8	152.0	152.2	152.8	152.9	152.5	153.1	155.2	161.8	1.39 p.m.	146.1	0.54	''	
30	155.2	153.5	153.7	154.3	155.3	155.5	a	a	a	a	a	a	a	a	a	a	a	a	134.3	128.3	145.9	146.8	143.8	149.0	142.7	161.0	4.55 a.m.	122.0	7.18	''	

HOURLY VALUES.

## DECLINATION, MAY, 1902.

Day.	D = 151° +																								Maximum reading and time.		Minimum reading and time.		
	Midt.	Forenoon.										Noon.	Afternoon.										Midt.						
		0.	1.	2.	3.	4.	5.	6.	7.	8.	9.		10.	11.	12.	1.	2.	3.	4.	5.	6.	7.		8.					9.
1	142.7	148.5	158.0	161.4	155.4	153.3	157.7	163.4	162.5	155.1	153.0	152.6	a	a	a	a	a	a	a	a	a	a	a	a	175.3	7.19 a.m.	131.6	8.30 p.m.	
2	150.1	152.5	148.4	153.3	163.1	175.7	168.4	163.6	151.7	160.1	153.4	151.7	152.2	143.2	141.2	137.9	138.5	140.3	132.5	139.6	141.1	142.6	145.7	148.0	151.1	182.5	6.55 ..	123.2	6.8 ..
3	151.1	149.3	153.4	155.3	158.8	168.2	159.2	165.8	167.0	162.4	159.4	157.0	155.8	151.5	149.9	147.7	145.4	144.2	146.0	145.7	147.4	147.8	149.5	152.3	152.2	177.1	9.25 ..	137.8	5.30 ..
4	152.2	151.6	152.5	155.3	154.7	163.5	156.5	156.1	165.1	159.8	157.3	160.1	155.5	155.3	149.8	152.3	145.4	131.5	136.3	119.0	125.0	137.9	149.6	144.1	148.0	174.5	8.35 ..	108.5	6.54 ..
5	148.0	154.6	155.3	157.6	174.4	184.0	179.3	169.6	167.0	161.5	159.1	158.3	150.5	153.4	151.3	150.2	149.8	152.8	153.1	153.5	154.7	155.5	156.1	155.9	156.8	192.5	5.10 ..	146.9	2.48 ..
6	156.8	158.2	162.7	168.8	164.0	160.4	163.6	161.6	161.8	158.5	158.9	161.0	161.5	155.5	150.1	152.0	151.0	152.8	150.2	148.3	143.3	152.8	154.9	155.3	154.9	177.5	3.25 ..	138.5	7.27 ..
7	154.9	155.2	155.3	156.1	155.0	158.6	163.7	162.5	161.8	159.4	157.4	154.9	155.0	152.5	148.9	153.2	154.0	154.7	155.3	155.6	133.9	141.7	141.5	149.3	143.6	170.0	6.10 ..	128.0	8.17 ..
8	143.6	157.0	155.5	156.8	173.9	186.1	168.4	163.9	170.2	160.7	162.7	164.8	164.8	160.7	158.0	157.0	151.0	152.2	148.4	150.4	154.7	156.7	157.7	153.2	158.0	199.3	4.35 ..	134.8	0.18 ..
9	158.0	150.2	147.1	164.3	240.2	216.1	206.8	143.8	155.3	163.1	164.9	156.2	151.9	144.7	135.1	121.0	108.4	92.5	89.3	74.5	102.8	149.9	150.1	156.8	159.1	272.0	4.18 ..	59.0	6.50 ..
10	159.1	187.6	179.5	248.0	258.5	246.5	258.5	246.5	c	c	231.5	263.0	c	203.0	199.0	154.0	141.5	132.5	132.1	121.6	117.1	108.5	121.0	142.6	135.5	266.8	6.38 ..	96.5	9.20 ..
11	135.5	148.4	150.8	146.0	151.0	161.0	159.5	167.5	157.6	156.1	160.0	157.0	154.3	a	a	a	a	a	a	a	a	a	a	a	a	182.0	6.34 ..	137.8	0.1 a.m.
12	a	a	a	a	a	a	a	a	a	a	a	a	a	146.3	146.5	147.1	147.1	146.3	143.5	142.9	144.2	145.3	147.1	148.7	152.3	159.5	11.54 p.m.	138.5	7.14 p.m.
13	152.3	151.6	154.4	150.5	c	c	c	152.5	152.0	152.0	152.5	152.3	152.0	150.5	149.8	145.6	145.0	137.5	132.1	143.8	a	a	a	a	a	160.3	7.15 a.m.	110.0	6.10 ..
14	a	a	a	a	a	a	a	a	a	a	a	a	a	a	a	a	a	a	a	a	a	a	a	a	a	182.0	6.34 ..	137.8	0.1 a.m.
15	a	a	a	a	a	a	a	a	a	a	a	a	a	a	a	a	a	a	a	a	a	a	a	a	a	182.0	6.34 ..	137.8	0.1 a.m.
16	156.2	155.8	156.7	156.1	158.0	156.4	157.4	158.0	156.8	158.6	159.1	156.8	156.5	155.3	154.9	155.9	152.3	154.3	155.5	155.8	155.3	155.5	154.0	157.0	160.6	165.5	9.35 a.m.	150.5	10.12 ..
17	160.6	162.7	160.0	160.7	161.6	163.0	162.5	164.0	162.5	162.4	161.8	158.9	163.0	160.3	158.3	159.2	159.5	158.3	157.6	158.8	156.7	156.8	159.7	158.3	159.8	167.8	10.25 ..	155.0	11.6 a.m.
18	159.8	159.8	160.0	160.4	162.4	164.3	165.1	176.3	171.5	177.1	181.4	182.0	175.3	165.1	179.0	164.0	153.1	157.7	158.0	157.0	152.5	143.9	136.6	149.8	152.3	197.0	11.25 ..	131.8	10.4 p.m.
19	152.3	163.0	168.5	167.3	166.6	162.5	164.9	164.8	160.9	164.9	165.2	167.5	166.6	166.0	159.1	159.2	158.3	157.1	151.0	152.3	148.0	146.5	157.6	159.8	162.1	176.0	4.28 ..	134.8	8.47 ..
20	162.1	152.0	161.8	160.7	166.0	168.8	165.5	166.6	170.0	173.5	183.5	187.6	186.1	170.0	163.3	157.0	157.3	157.6	158.0	153.8	151.4	150.8	156.7	163.6	165.5	199.7	10.24 ..	129.5	8.20 ..
21	165.5	165.5	163.7	163.3	164.3	163.7	162.5	163.6	166.7	165.8	162.2	161.0	160.0	157.3	158.0	156.5	154.0	156.7	155.0	156.5	156.8	156.2	156.5	157.7	157.6	192.5	9.30 ..	146.0	5.33 ..
22	157.6	161.3	162.1	155.5	156.5	166.6	166.0	162.4	162.1	165.5	164.5	165.1	163.7	160.1	158.3	158.3	158.0	158.3	142.0	152.5	157.3	153.2	156.1	160.4	161.8	179.0	4.40 ..	128.0	6.26 ..
23	161.8	163.1	162.8	164.2	162.4	162.5	163.3	166.0	163.7	164.5	168.8	165.1	166.7	161.8	161.5	161.3	159.1	154.7	156.1	162.5	a	a	a	a	a	172.4	10.15 ..	145.3	5.45 ..
24	a	a	a	a	a	a	a	a	a	a	a	a	a	a	a	a	a	161.0	162.4	162.8	163.9	164.0	165.5	165.1	166.3	166.3	11.43 p.m.	159.5	5.16 ..
25	166.3	162.1	162.1	160.3	164.0	164.5	165.2	170.0	171.8	170.0	185.3	173.3	176.8	173.3	169.7	156.1	155.8	157.6	157.9	160.9	155.2	157.0	164.3	167.8	167.0	197.8	10.13 a.m.	147.5	3.4 ..
26	167.0	162.2	167.0	170.3	166.0	166.6	169.3	170.3	175.7	176.0	174.5	175.3	176.2	183.4	164.3	157.0	159.2	159.8	160.3	161.3	162.5	164.3	164.5	165.2	167.8	194.8	0.45 p.m.	150.5	4.35 ..
27	167.8	161.0	166.6	171.1	168.1	168.1	175.6	179.3	176.9	176.5	173.3	174.2	167.0	170.8	173.3	164.5	160.0	156.5	160.0	158.6	161.0	162.2	161.5	161.5	163.7	185.0	7.58 a.m.	152.0	4.56 ..
28	163.7	166.6	166.0	164.0	164.5	164.3	162.8	169.6	169.3	171.2	173.0	165.2	168.2	170.0	160.7	159.5	161.3	159.8	161.5	161.5	160.0	163.0	165.1	166.6	166.7	180.8	8.58 ..	155.0	8.0 ..
29	166.7	165.5	164.3	165.1	163.0	162.2	165.1	168.1	165.8	164.5	172.6	168.5	166.4	166.6	162.2	164.5	164.0	161.5	159.4	158.6	153.5	158.5	160.6	154.6	160.9	182.0	9.55 ..	142.3	8.15 ..
30	160.9	164.5	174.2	174.1	166.6	170.0	168.5	164.0	180.1	182.0	167.8	166.0	167.9	170.9	169.7	156.5	137.3	119.8	151.7	152.5	147.8	157.7	163.0	168.4	168.5	203.8	8.20 ..	111.5	4.20 ..
31	168.5	170.5	173.3	169.9	168.5	173.0	169.1	169.6	171.1	167.5	166.3	169.0	167.3	169.7	166.3	163.6	159.2	159.4	155.0	149.0	158.5	163.3	164.0	163.4	168.2	179.5	0.5 p.m.	141.5	6.45 ..

DECLINATION, JUNE, 1902.

Day.	D = 151° +																								Maximum reading and time.	Minimum reading and time.			
	Midt.	Forenoon.										Noon.	Afternoon.										Midt.						
		0.	1.	2.	3.	4.	5.	6.	7.	8.	9.		10.	11.	12.	1.	2.	3.	4.	5.	6.	7.		8.			9.	10.	11.
1	115.2	115.2	113.0	113.3	124.5	114.5	118.2	120.3	123.3	123.8	117.0	135.5	125.7	126.3	104.0	101.7	103.1	97.1	82.1	56.6	74.0	89.7	90.8	107.6	117.0	147.0	10.33 a.m.	28.8	7.10 p.m.
2	117.0	111.8	108.2	113.9	119.4	121.1	122.6	132.9	126.9	126.0	119.9	120.0	111.2	110.7	110.3	107.3	107.0	101.7	101.0	104.7	105.5	109.2	109.2	110.1	109.7	141.0	6.36 ..	97.5	6.35 ..
3	109.7	110.0	108.0	108.2	108.5	109.2	108.8	109.8	111.9	111.0	109.2	108.3	109.8	109.7	109.2	110.0	108.3	107.0	94.1	101.9	106.5	107.3	110.1	111.5	106.8	114.9	8.28 ..	75.8	5.49 ..
4	106.8	108.8	111.5	112.5	112.2	110.9	112.2	113.3	109.8	111.3	112.7	113.3	109.5	109.4	107.7	110.1	108.5	108.0	108.0	108.5	107.6	108.2	110.1	105.6	106.2	117.0	7.26 ..	100.5	11.52 ..
5	106.2	110.0	107.0	115.7	107.9	109.5	112.5	111.8	111.3	113.6	113.9	112.5	114.5	111.0	110.7	105.8	105.9	106.1	106.5	106.8	106.8	108.3	109.8	109.1	109.4	123.3	9.18 ..	96.6	1.35 ..
6	109.4	109.5	108.6	108.3	108.3	107.6	107.9	110.7	113.7	109.2	112.8	118.5	117.3	114.5	111.5	106.8	104.4	107.6	95.0	92.6	107.0	110.0	110.0	109.5	106.1	123.3	11.55 ..	73.5	6.39 ..
7	106.1	112.2	105.5	112.5	121.5	117.5	107.6	138.0	131.0	132.5	126.5	127.5	122.7	120.6	122.1	121.1	115.2	113.3	112.7	104.6	103.3	106.5	99.5	107.0	108.8	153.0	6.44 ..	88.2	9.58 ..
8	108.8	114.8	109.1	106.2	104.6	105.8	116.3	115.1	116.6	113.6	120.5	125.4	116.7	124.1	117.6	117.5	106.4	97.5	92.0	90.5	107.0	110.3	109.1	111.0	112.1	142.5	8.25 ..	79.5	6.55 ..
9	112.1	115.5	113.6	113.0	112.8	116.0	112.8	114.5	114.3	118.2	117.6	116.7	118.5	119.7	117.2	116.6	115.4	116.1	112.5	112.4	113.4	114.3	117.9	118.1	116.1	122.0	9.34 ..	103.5	7.53 ..
10	116.1	119.0	118.4	116.9	115.8	115.8	116.0	122.0	121.2	116.6	120.6	a	a	a	a	a	a	a	a	a	a	a	a	a	a	133.5	8.3 ..	111.0	4.55 a.m.
11	a	a	a	a	a	a	a	a	a	a	a	a	a	a	a	a	a	a	a	a	a	a	a	a	a	126.0	11.42 p.m.	88.5	6.25 p.m.
12	117.8	111.6	114.2	119.7	126.5	135.5	121.8	120.5	131.6	132.0	149.7	133.5	121.5	119.7	115.2	114.0	114.5	110.9	88.5	61.8	107.0	119.7	111.0	119.3	110.7	163.5	10.5 a.m.	21.5	6.45 ..
13	110.7	123.0	121.1	122.0	121.1	126.0	126.0	130.2	127.2	123.8	127.7	129.6	142.8	141.3	122.7	121.4	116.7	119.9	117.3	116.6	116.3	113.7	108.3	115.2	121.5	151.5	0.49 p.m.	105.0	10.11 ..
14	121.5	124.5	122.0	122.6	123.9	123.3	123.0	124.1	125.0	124.5	123.0	127.5	126.0	127.2	124.4	118.8	107.6	107.3	106.5	112.7	115.8	108.6	110.9	117.8	124.1	135.8	11.1 a.m.	98.0	4.55 ..
15	124.1	125.6	123.5	124.1	124.1	128.7	126.0	126.8	130.8	118.5	127.1	127.4	128.0	128.7	127.1	123.8	123.0	117.8	115.2	113.0	120.5	119.5	118.7	107.6	125.3	150.8	8.22 ..	99.0	10.44 ..
16	125.3	105.0	130.8	122.3	125.0	125.6	123.3	124.8	123.8	123.5	132.5	131.1	126.0	127.2	124.1	125.7	120.5	115.5	113.7	123.5	112.1	124.1	124.1	127.5	127.1	150.0	2.10 ..	81.9	0.33 a.m.
17	127.1	128.0	126.6	126.9	127.8	128.7	127.5	127.5	129.0	129.0	127.5	128.6	127.1	126.5	125.4	126.2	126.3	124.2	126.0	125.0	124.1	123.3	125.6	127.1	126.3	132.0	2.5 ..	119.4	5.23 p.m.
18	126.3	127.1	124.1	125.1	125.7	124.4	126.6	125.0	127.1	130.1	129.2	130.4	128.4	127.8	129.9	129.0	125.7	122.0	117.8	119.0	110.6	118.2	130.5	125.7	127.8	137.7	11.22 ..	96.0	8.25 ..
19	127.8	129.0	127.5	129.0	126.0	127.2	126.5	128.0	130.1	132.9	130.2	128.6	125.1	128.0	126.3	125.3	128.3	128.6	128.4	129.0	128.7	127.2	126.2	129.2	128.3	138.0	9.55 ..	118.8	3.10 a.m.
20	128.3	127.2	127.8	129.3	127.8	131.6	130.2	134.0	136.8	135.0	139.8	128.1	124.1	125.6	126.5	126.6	126.8	123.5	125.4	125.3	126.0	127.2	128.3	129.6	129.8	148.5	10.5 ..	111.8	4.46 p.m.
21	129.8	129.3	128.9	131.4	129.5	127.8	130.8	128.9	128.6	129.5	130.1	130.5	131.3	129.2	129.0	127.8	127.5	127.7	129.2	130.1	129.6	129.5	128.7	125.4	130.5	135.6	3.5 ..	124.5	11.17 ..
22	130.5	134.4	129.9	128.0	127.2	128.3	123.7	129.5	131.9	131.9	133.7	130.5	127.5	125.6	125.3	125.6	121.4	119.7	102.0	97.2	101.7	79.1	116.3	117.9	120.8	143.4	0.9 ..	66.8	8.52 ..
23	120.8	128.9	135.9	137.6	134.6	132.3	136.8	150.5	153.5	159.0	163.1	149.3	141.8	130.5	130.2	127.8	126.5	120.5	123.3	124.5	125.3	128.6	132.0	133.8	134.4	172.2	10.6 ..	116.1	7.28 ..
24	134.4	134.6	133.8	130.8	131.7	132.3	130.8	131.7	131.0	131.7	131.7	132.0	132.0	132.6	134.6	132.0	132.6	129.8	128.9	129.5	128.3	121.1	118.5	127.2	139.2	146.7	11.41 p.m.	104.3	9.22 ..
25	139.2	129.5	130.5	130.8	132.0	140.4	143.4	149.6	145.1	143.0	146.0	146.9	145.5	144.0	152.3	129.8	128.3	117.3	123.3	119.1	123.0	129.8	133.8	132.6	134.9	165.0	7.32 a.m.	109.2	5.3 ..
26	134.9	135.5	138.6	136.8	135.5	134.3	137.0	133.8	138.6	139.1	136.5	142.1	141.0	133.5	149.7	129.0	129.0	123.5	108.3	94.4	104.7	129.9	128.6	135.3	135.3	160.8	2.0 p.m.	88.5	7.0 ..
27	135.3	133.8	144.2	138.6	153.3	140.3	136.2	146.3	144.9	152.6	139.1	138.3	138.8	135.0	134.9	134.3	131.6	135.6	125.7	132.6	122.7	106.1	125.0	127.4	138.8	165.8	8.58 a.m.	91.8	8.45 ..
28	138.8	137.6	134.6	141.0	138.5	138.2	145.7	141.5	141.9	152.7	143.4	142.5	144.0	142.1	138.0	137.6	135.2	131.7	131.9	135.0	133.1	134.9	134.1	135.9	134.3	164.6	9.21 ..	119.3	7.25 ..
29	134.3	134.3	137.6	138.2	135.8	141.2	161.9	168.6	156.5	146.9	142.1	140.0	137.3	135.8	136.7	134.1	132.0	132.5	131.6	125.0	94.1	95.6	117.5	109.1	123.0	181.5	6.45 ..	55.5	7.20 ..
30	123.0	144.8	137.3	163.5	181.1	180.5	147.0	145.1	143.6	143.6	157.1	148.5	154.5	149.0	138.0	126.5	120.5	118.1	127.1	123.0	93.5	106.5	124.5	141.5	136.1	204.3	4.21 ..	75.3	8.25 ..

02

HOURLY VALUES.

11



DECLINATION, AUGUST, 1902.

D = 150° +

Day.	Midt.	Forenoon.										Noon.	Afternoon.										Midt.	Maximum reading and time.		Minimum reading and time.			
		0.	1.	2.	3.	4.	5.	6.	7.	8.	9.		10.	11.	12.	1.	2.	3.	4.	5.	6.	7.		8.	9.	10.	11.	12.	
1	148°6	148°1	147°2	147°1	147°8	148°7	149°9	151°3	150°5	150°2	152°3	153°5	149°0	148°7	149°9	150°7	149°5	148°6	147°1	147°1	137°0	140°8	148°0	152°0	155°9	158°0	10.46 p.m.	123°8	7.39 p.m.
2	155°9	151°1	154°0	152°5	152°3	152°6	152°3	153°8	154°6	154°1	153°7	153°5	148°6	146°0	145°6	145°7	146°0	146°8	144°1	148°3	145°6	147°5	149°2	146°2	151°3	157°9	10.3	137°6	11.25
3	151°3	154°6	148°9	154°4	151°7	158°8	154°0	157°0	157°6	156°8	162°5	157°6	156°5	147°8	148°3	149°3	125°0	126°1	140°8	142°3	148°1	150°8	153°1	153°1	152°0	167°5	10.25 a.m.	105°5	4.35
4	152°0	151°3	151°3	149°5	149°5	151°6	153°8	153°1	160°6	163°6	154°0	160°6	147°5	146°8	157°6	145°6	137°5	131°0	133°0	127°6	108°5	138°6	152°9	152°9	150°1	171°5	9.43	98°5	7.42
5	150°1	152°0	151°0	154°0	152°0	154°6	156°5	158°5	159°1	156°4	157°6	156°2	148°3	149°8	149°0	146°9	144°4	142°9	142°6	143°0	146°9	145°7	146°5	149°5	149°8	167°2	7.26	134°0	7.23
6	149°8	153°1	152°3	147°1	151°0	155°5	152°8	153°5	154°1	153°5	153°1	152°0	150°5	150°5	151°3	150°1	149°3	148°0	150°8	151°4	150°1	151°6	152°0	152°5	156°5	163°3	7.37	141°5	2.55 a.m.
7	156°5	153°8	153°5	154°3	154°6	156°8	156°1	155°5	157°0	158°8	159°5	158°9	156°2	156°5	153°5	151°6	148°6	150°2	152°2	a	a	a	a	a	a	162°8	9.25	146°8	4.10 p.m.
8	a	a	a	a	a	a	a	a	a	a	a	a	162°8	162°1	155°9	153°1	155°2	153°4	156°5	157°0	156°1	157°0	156°5	157°6	161°2	170°0	11.55	150°5	2.58
9	161°2	162°4	162°8	161°9	162°5	162°8	162°1	167°0	169°3	166°3	166°3	162°5	162°5	159°7	155°9	152°9	150°1	150°7	153°5	152°8	149°5	140°0	136°3	138°5	148°0	174°5	8.17	123°5	10.10
10	148°0	158°3	159°8	155°5	156°1	157°7	159°5	178°0	157°0	158°8	161°0	168°5	161°0	157°6	156°7	158°8	157°1	155°5	154°6	153°7	156°2	156°4	156°1	157°1	156°2	187°3	6.50	144°5	8.35 a.m.
11	150°2	156°5	159°5	159°8	159°2	169°0	169°6	170°0	196°6	198°1	188°0	208°4	186°1	164°8	149°6	138°1	126°5	134°0	147°5	140°5	133°6	144°5	156°2	158°0	153°8	216°2	11.25	104°5	3.56 p.m.
12	153°8	162°5	160°6	175°0	166°7	163°4	164°5	166°6	167°0	168°1	169°0	171°2	165°5	170°8	162°1	160°0	159°5	158°0	160°0	159°7	159°1	161°0	159°5	160°6	159°5	195°2	3.18	149°3	0.2 a.m.
13	159°5	163°6	164°0	166°0	166°3	167°5	166°7	165°5	166°3	164°3	166°6	165°8	(165°9)	166°0	161°3	161°3	159°8	156°1	154°7	155°5	159°1	155°6	159°1	162°5	164°5	171°5	7.6	147°5	5.42 p.m.
14	164°5	167°9	166°9	168°2	168°2	169°7	170°5	169°6	169°0	168°5	169°0	168°5	164°0	158°8	158°5	159°5	160°3	159°7	157°7	156°4	147°1	160°6	159°5	162°5	163°3	173°8	5.35	135°5	8.3
15	163°3	166°9	165°2	165°8	166°0	167°3	167°0	167°0	168°1	171°5	172°0	169°6	164°9	163°9	161°8	159°1	160°6	158°0	155°0	156°2	158°2	162°2	159°7	161°9	163°0	176°0	10.28	149°6	6.58
16	163°0	166°3	164°6	165°2	166°0	166°6	168°2	170°0	169°3	170°5	171°5	170°2	169°0	164°0	166°0	165°2	164°5	161°3	160°6	157°6	154°0	143°3	153°2	159°1	163°0	186°2	7.5	133°4	7.11
17	163°0	157°3	165°4	169°7	170°0	171°4	171°1	171°1	170°0	171°5	171°5	174°5	167°9	164°5	163°4	165°1	163°4	162°5	165°2	166°7	165°5	165°5	164°0	164°0	161°0	178°0	2.8	154°3	0.6 a.m.
18	161°0	165°5	163°4	171°8	173°0	169°6	171°5	183°5	189°5	178°7	169°6	167°5	171°1	159°5	149°0	137°8	142°6	141°5	143°0	121°0	120°8	134°5	143°2	158°0	165°1	199°6	7.48	108°5	7.5 p.m.
19	165°1	173°3	174°5	175°0	173°5	171°5	173°0	173°3	173°0	174°1	173°6	175°1	171°5	163°3	159°4	159°2	158°6	159°4	160°9	161°3	160°3	160°9	161°2	161°5	162°2	186°5	2.25	157°7	3.20
20	162°2	160°7	160°9	161°0	162°1	163°6	163°1	163°7	166°9	166°0	169°7	162°5	162°1	159°2	155°3	156°8	157°0	157°6	158°0	155°3	156°8	160°3	159°7	160°1	161°3	176°8	9.36	152°0	1.28
21	161°3	161°9	163°0	161°3	162°2	162°5	161°6	164°0	171°2	168°8	171°5	172°4	159°5	169°6	155°0	153°5	149°5	147°5	147°5	140°5	120°1	134°0	145°6	155°5	155°0	183°1	8.20	115°3	7.35
22	155°0	167°5	179°0	179°0	186°1	205°6	249°5	253°0	248°0	270°5+	258°5	218°0	165°5	143°5	141°5	136°0	115°6	103°0	134°0	140°5	93°1	157°0	163°6	148°6	167°5	270°5+	9.0	59°8	8.15
23	167°5	171°1	164°5	166°0	166°0	164°3	170°3	167°0	174°5	176°0	170°5	173°0	170°2	182°0	173°5	161°0	156°1	152°5	149°0	119°5	155°0	154°0	161°0	160°0	157°0	196°3	2.5	98°0	7.5
24	167°0	162°1	159°5	161°0	172°0	173°0	166°0	168°1	181°0	197°5	193°0	188°0	172°6	167°0	149°0	123°5	137°5	129°1	126°1	135°1	150°1	158°5	158°0	162°5	155°5	213°8	9.59 a.m.	105°5	6.14
25	155°5	161°0	155°5	154°6	168°5	168°1	166°6	173°5	180°5	185°0	184°6	172°6	162°5	156°1	162°5	153°1	148°7	152°0	137°0	151°0	134°0	150°1	156°1	165°5	157°6	204°5	7.50	124°4	6.6
26	157°6	162°5	163°6	170°5	166°0	169°6	171°5	190°0	178°0	164°5	168°5	162°5	(163°3)	164°0	147°5	142°6	151°3	152°5	154°6	160°0	155°5	155°5	159°5	156°5	159°1	217°3	7.10	133°3	1.50
27	159°1	159°5	164°0	160°3	165°8	166°0	163°6	160°6	165°5	161°0	162°1	160°6	156°5	153°5	151°0	146°8	145°6	152°5	153°1	140°0	141°1	143°0	148°0	160°0	160°7	183°5	7.55	131°0	7.29
28	160°7	161°5	156°1	157°0	158°0	164°0	172°0	172°6	177°1	165°1	164°5	163°3	162°8	153°5	157°6	155°5	155°5	155°5	157°0	150°5	156°1	160°0	160°6	162°5	159°1	194°0	7.50	138°5	7.18
29	159°1	159°5	164°5	171°1	165°5	164°5	166°0	170°5	170°5	166°0	166°7	164°8	162°5	155°0	154°0	153°5	154°6	155°5	153°8	154°6	157°6	156°1	157°6	160°0	157°3	203°8	9.20	146°0	6.17
30	157°3	164°5	161°0	164°5	165°1	165°1	165°1	170°0	174°1	169°6	164°3	164°5	164°0	152°5	151°0	149°0	150°1	152°0	151°6	135°5	159°1	158°5	159°5	158°5	158°0	179°3	7.43	126°5	6.40
31	158°0	160°0	158°5	160°0	160°6	162°1	162°5	164°0	163°0	162°1	164°0	160°3	155°0	153°1	152°0	152°5	150°1	148°0	151°6	148°6	134°5	97°0	129°1	134°5	149°5	171°5	10.8	47°0	9.0

HOURLY VALUES.



DECLINATION, SEPTEMBER, 1902.

Day.	D = 150° +																								Maximum reading and time.		Minimum reading and time.			
	Midt.	Forenoon.										Noon.	Afternoon.										Midt.							
		0.	1.	2.	3.	4.	5.	6.	7.	8.	9.		10.	11.	12.	1.	2.	3.	4.	5.	6.	7.		8.					9.	10.
1	144.5	152.0	157.5	161.0	162.0	181.5	192.0	188.0	186.0	168.5	160.5	166.4	168.9	148.4	154.1	155.9	143.4	146.1	145.7	146.0	152.6	156.6	155.4	153.5	154.4	210.0	7.30 a.m.	137.4	4.13 p.m.	
2	154.4	153.9	154.5	155.0	157.4	158.6	157.8	160.5	161.0	159.5	158.0	164.0	168.8	158.3	158.7	148.5	136.1	135.3	132.0	100.2	118.1	153.2	140.3	139.8	156.6	176.0	11.35	61.5	7.15	..
3	156.6	153.3	157.7	180.0	208.2	189.3	207.8	200.6	195.5	189.5	182.6	178.5	162.0	163.5	160.2	143.6	131.3	130.5	130.5	130.4	137.1	143.1	141.0	150.8	160.1	221.6	3.50	119.0	5.15	..
4	160.1	163.1	162.3	162.0	161.6	168.5	176.4	181.5	183.0	184.8	177.8	176.9	158.3	162.0	162.3	158.9	145.4	134.6	116.7	107.7	128.9	124.5	157.5	158.0	156.0	193.1	8.8	84.0	6.32	..
5	156.0	159.3	154.1	161.6	169.5	176.9	181.1	173.4	170.0	180.0	183.0	169.5	175.1	166.1	161.0	151.5	150.5	150.0	149.0	138.0	147.0	152.0	153.5	156.0	158.0	198.0	7.26	129.3	6.40	..
6	158.0	158.6	157.1	157.1	155.0	156.0	156.0	157.5	158.0	155.0	153.5	153.3	154.2	146.0	143.0	136.5	133.1	130.0	124.5	147.0	149.0	145.1	147.0	145.5	154.1	168.6	11.50 p.m.	102.3	5.20	..
7	154.1	163.1	158.0	159.0	158.6	160.1	168.5	169.1	167.6	174.5	169.5	167.6	162.0	158.6	163.5	158.0	139.5	130.1	137.0	139.5	147.0	149.0	152.6	152.6	157.1	194.3	7.32 a.m.	123.0	4.50	..
8	157.1	158.0	160.1	156.5	159.0	158.0	160.5	158.0	162.0	160.5	153.0	151.0	147.0	148.5	150.0	151.1	151.5	151.1	152.0	152.6	151.5	152.6	154.5	155.6	156.6	165.5	8.2	136.5	11.50 a.m.	..
9	155.6	158.0	158.6	160.5	161.6	165.5	168.5	168.0	168.0	173.0	174.0	175.8	168.0	162.5	156.0	152.0	148.5	137.0	135.0	143.6	147.0	152.6	153.0	155.6	153.5	186.0	8.55	127.5	5.23 p.m.	..
10	153.5	153.0	150.5	154.5	156.5	158.0	161.0	164.0	169.1	171.5	164.0	150.0	151.1	145.5	148.1	145.5	144.5	146.6	149.0	143.0	131.6	138.5	135.5	135.5	148.5	175.5	8.58	112.5	8.20	..
11	148.5	149.6	157.5	160.1	173.6	174.0	177.0	178.5	182.6	186.5	183.0	177.0	175.1	167.0	154.5	144.0	138.0	140.0	130.1	132.0	136.1	141.5	147.0	153.0	157.1	194.4	9.25	124.1	7.26	..
12	157.1	157.1	157.5	158.0	167.6	175.1	185.0	176.0	171.5	169.5	166.5	163.0	152.6	142.1	133.1	149.0	144.5	137.6	144.5	146.6	148.1	148.1	143.0	148.5	145.5	191.0	6.16	124.5	9.56	..
13	145.5	162.0	159.0	171.0	200.6	225.5	212.6	200.6	200.0	201.0	207.0	187.5	169.5	175.1	163.8	156.3	149.0	144.0	139.5	141.5	142.1	150.0	152.6	153.0	153.0	237.0	4.57	131.6	6.45	..
14	153.0	154.5	153.5	152.6	154.5	155.6	156.0	154.1	151.5	153.5	155.0	144.0	141.0	138.0	138.0	141.0	139.5	142.8	145.5	148.5	150.5	151.5	152.6	152.6	153.5	163.5	9.43	132.0	1.46	..
15	153.5	154.5	154.5	155.6	156.0	156.0	157.5	158.6	157.5	156.0	157.5	148.8	147.0	143.3	139.8	143.7	138.8	138.0	140.0	150.3	147.9	150.2	151.8	151.4	151.7	165.0	8.38	123.0	4.54	..
16	151.7	151.8	152.3	153.5	154.1	153.5	155.9	158.6	157.1	155.9	166.1	152.4	150.0	143.7	141.9	136.4	137.0	134.7	139.7	141.6	138.0	139.7	149.9	156.0	160.4	182.4	9.56	126.2	9.29	..
17	160.4	158.0	157.4	156.5	159.2	161.9	169.1	170.3	178.1	177.0	175.8	a	a	a	153.0	130.5	131.0	122.0	145.5	149.6	154.1	154.5	154.1	148.5	148.1	183.9	8.43	108.9	4.57	..
18	148.1	152.0	152.0	170.0	179.0	164.6	165.0	160.5	162.0	164.0	156.5	186.0	159.5	149.1	137.6	134.0	143.6	139.1	136.5	142.1	146.0	144.0	140.6	151.1	159.0	190.5	10.58	123.0	10.10	..
19	159.0	162.0	155.6	159.5	162.5	160.5	167.0	202.1	261.1+	151.5	171.0	162.5	a	a	a	a	a	a	a	a	a	a	a	a	a	261.0+	8.10	141.8	0.35 a.m.	..
20	a	a	a	a	a	a	a	a	a	a	a	a	a	a	133.5	97.5	99.5	68.6	119.0	118.5	82.1	119.6	136.1	147.0	162.5	196.5	11.2 p.m.	23.3	4.50 p.m.	..
21	162.5	176.6	171.0	154.5	165.5	178.5	203.0	201.5	224.3	238.8	192.0	173.0	174.0	187.5	187.1	163.1	148.5	138.2	148.1	149.6	147.5	159.5	157.1	153.0	166.1	261.0+	8.35 a.m.	129.8	5.45	..
22	166.1	160.1	167.0	170.7	169.2	166.1	170.6	170.0	183.5	185.6	176.0	166.5	171.0	165.0	157.5	154.5	150.5	154.1	156.0	157.1	154.1	152.6	155.6	166.1	166.1	192.0	10.3	141.6	5.55	..
23	166.1	162.5	162.0	166.1	167.6	187.1	210.5	211.1	192.5	195.5	195.0	209.7	180.0	175.5	174.5	156.5	135.5	118.5	143.6	147.0	129.0	141.0	154.5	150.0	171.5	244.2	7.40	100.5	4.56	..
24	171.5	163.5	170.0	164.0	173.6	191.6	198.0	195.0	208.1	187.1	179.6	171.0	181.5	164.0	170.6	168.5	165.5	153.5	149.0	147.5	152.6	161.6	166.5	167.0	162.5	231.6	8.6	133.5	6.15	..
25	162.5	166.1	169.1	171.0	170.0	171.0	174.5	174.0	180.5	174.5	158.0	175.0	161.6	162.5	159.5	149.6	157.5	158.0	148.1	151.5	162.0	161.0	163.5	164.4	166.5	189.0	8.3	126.8	6.25	..
26	166.5	161.6	169.5	187.1	180.5	184.1	173.0	184.1	184.1	178.1	172.5	155.7	152.0	167.0	154.1	163.8	161.7	152.7	138.9	148.1	156.5	157.1	163.2	170.0	167.7	204.5	6.3	121.5	6.18	..
27	167.7	166.7	169.2	171.0	170.0	174.8	183.3	187.1	184.8	185.1	186.0	184.5	174.0	165.0	142.5	146.6	147.5	152.6	152.6	147.5	150.0	156.5	162.5	159.0	167.0	195.6	8.54	136.5	7.10	..
28	167.0	179.0	169.5	171.5	175.1	180.0	188.0	189.0	205.5	209.6	219.0	201.0	205.1	196.1	178.5	168.0	161.0	156.0	156.0	155.6	159.0	160.5	a	a	a	234.6	9.12	150.0	5.15	..
29	a	a	a	a	a	a	a	a	a	a	a	204.0	186.0	183.5	171.5	164.6	166.5	161.6	153.5	151.1	158.0	161.6	166.1	169.1	166.1	219.8	10.43	141.0	7.10	..
30	166.1	167.0	173.0	174.5	172.5	179.0	175.5	190.1	202.1	212.1	194.0	166.1	177.5	193.1	146.0	162.5	154.1	152.6	151.5	149.6	151.5	158.6	163.5	162.5	169.1	237.9	8.50	124.5	1.50	..

DECLINATION, OCTOBER, 1902.

D = 149° +

Day.	Midt.	Forenoon.											Noon.	Afternoon.											Midt.	Maximum reading and time.		Minimum reading and time.		
		0.	1.	2.	3.	4.	5.	6.	7.	8.	9.	10.		11.	1.	2.	3.	4.	5.	6.	7.	8.	9.	10.						11.
1	236.1	232.0	233.5	a	a	a	a	a	a	a	a	313.0+	293.5	275.1	230.1	207.7	207.0	204.6	195.6	200.1	210.6	214.8	219.6	229.5	237.1	313.0+	11.0 a.m.	185.5	5.50 p.m.	
2	237.1	237.7	236.2	243.0	255.6	262.8	266.5	a	a	a	a	255.7	256.8	261.7	254.1	238.5	227.1	218.8	212.4	211.5	203.4	204.3	225.3	226.5	228.6	275.5+	6.35 "	195.3	8.4 "	
3	228.6	241.5	237.6	247.0	247.5	238.0	242.1	247.5	256.0	262.5	a	a	a	a	211.5	211.5	218.1	213.6	220.0	222.6	226.0	227.5	224.1	236.1	235.0	275.5+	8.35 "	188.1	5.18 "	
4	235.0	234.0	235.0	235.0	229.5	242.5	244.0	244.5	235.8	236.4	249.0	280.5	254.5	224.1	225.6	218.5	206.1	200.1	209.1	216.6	224.5	228.6	221.1	233.1	231.6	292.0	10.38 "	182.5	4.30 "	
5	231.6	228.0	234.6	238.0	234.6	233.1	247.0	241.0	234.0	240.0	240.6	244.0	246.0	225.0	217.0	216.0	214.5	208.0	213.0	220.5	217.5	222.6	225.0	232.5	230.5	253.5	7.44 "	202.8	5.5 "	
6	230.5	232.0	233.5	238.5	235.5	237.0	233.5	233.1	248.5	233.1	230.5	233.5	232.0	224.5	219.6	216.6	214.0	207.0	218.1	218.5	219.0	220.0	231.0	231.6	232.5	266.5	8.0 "	197.5	4.58 "	
7	232.5	236.5	243.6	241.0	240.0	240.6	237.0	240.0	242.5	245.1	246.0	228.0	225.0	225.6	222.6	214.0	207.6	206.5	213.0	215.1	223.0	226.5	229.5	231.6	232.5	259.8	8.30 "	204.3	4.37 "	
8	232.5	235.0	235.5	236.1	235.0	235.0	234.6	232.5	239.1	247.5	229.5	225.0	224.5	216.0	211.0	208.5	224.5	225.6	212.5	218.1	222.0	227.5	227.5	222.0	232.0	259.8	8.57 "	196.0	3.8 "	
9	232.0	233.1	236.1	235.0	232.5	236.1	240.0	279.0	254.5	246.6	224.5	241.5	237.0	251.1	245.5	241.5	237.0	229.0	213.6	213.0	207.0	207.6	217.5	225.0	228.6	292.0	6.34 "	203.1	8.30 a.m.	
10	228.6	238.0	243.6	242.1	246.0	246.0	247.0	244.5	242.5	232.0	229.0	232.5	235.5	247.0	239.5	234.0	229.0	225.6	221.5	213.6	216.0	225.6	230.1	235.5	239.5	261.3	7.10 "	208.0	7.0 p.m.	
11	239.5	240.6	245.1	245.5	248.5	250.5	255.6	251.5	256.0	264.0	251.5	265.0	262.5	252.6	248.1	220.5	215.1	210.0	214.0	217.5	217.0	221.1	215.1	223.5	252.6	284.5	11.10 "	199.0	4.40 "	
12	252.6	238.0	239.5	226.5	256.5	313.5	291.6	305.5	328.5+	328.5+	297.6	257.5	243.6	247.5	238.5	221.5	223.5	217.5	218.1	219.0	217.0	212.1	228.0	240.6	233.5	328.0+	7-9 "	203.5	2.50 "	
13	233.5	237.6	244.0	250.0	243.0	262.0	263.5	266.5	261.0	256.0	231.6	236.8	227.5	219.6	216.0	214.5	224.1	219.6	222.0	224.5	225.0	226.0	220.5	239.5	243.0	293.5	6.33 "	205.0	2.32 "	
14	243.0	240.6	241.0	240.6	242.5	255.6	275.5	290.5	264.6	249.6	237.6	233.5	227.5	217.0	221.5	221.5	223.5	225.6	229.0	228.0	231.0	233.5	234.6	236.1	233.1	301.0	7.42 "	214.0	0.55 "	
15	233.1	240.6	241.5	248.0	244.0	251.1	253.5	258.0	264.0	270.6	274.5	263.1	260.5	251.5	251.8	235.9	213.6	204.0	198.0	212.7	205.6	210.9	229.8	244.5	246.9	287.5	9.36 "	194.5	5.46 "	
16	246.9	245.2	237.1	234.0	231.4	229.5	226.3	237.7	235.0	232.2	229.5	219.3	222.4	214.6	203.5	203.4	205.8	216.0	217.0	224.5	229.0	236.1	237.1	237.9	237.7	253.0	9.31 "	191.8	2.35 "	
17	237.7	238.3	238.9	239.8	239.5	246.1	234.6	226.0	222.1	229.2	[227.2]	[225.1]	223.0	210.6	212.1	213.6	204.0	201.0	192.6	207.6	215.1	229.0	236.1	238.5	240.0	277.6	10.43 "	187.0	5.53 "	
18	240.0	241.5	237.6	239.5	240.3	236.5	240.0	246.6	265.0	263.1	263.5	[243.0]	222.6	219.6	218.1	234.6	200.5	198.0	214.5	220.5	220.0	230.5	231.0	236.1	237.0	277.8	9.18 "	185.5	4.25 "	
19	237.0	235.5	241.5	241.0	248.1	259.0	281.1	290.1	290.1	269.1	284.1	268.5	254.5	254.1	223.0	199.5	202.5	211.0	212.5	223.0	223.0	232.5	240.0	240.0	242.5	328.0+	7.25 "	188.5	3.8 "	
20	242.5	240.6	244.5	242.5	232.6	233.1	244.5	250.5	251.1	253.5	242.8	235.5	231.0	241.5	239.1	239.1	229.0	225.6	213.6	216.0	222.6	216.6	224.5	244.0	249.0	262.8	8.20 "	208.0	9.10 "	
21	249.0	246.6	242.5	241.0	237.0	233.1	233.1	239.5	227.1	241.0	226.5	218.1	216.0	232.0	225.0	212.1	208.5	211.5	214.5	218.5	221.5	222.0	224.1	236.5	238.0	298.0	9.40 "	193.8	3.30 "	
22	238.0	233.5	232.0	235.5	236.5	243.6	241.0	219.0	212.1	229.5	247.0	235.0	218.1	208.5	206.1	196.0	192.6	191.5	192.6	206.1	218.1	223.5	232.0	236.1	236.1	263.5	10.5 "	179.5	3.26 "	
23	236.1	234.6	240.6	235.5	237.6	254.1	235.5	227.1	228.0	226.5	230.8	214.5	224.1	216.6	202.5	205.5	206.5	207.0	206.1	213.0	213.6	219.6	232.0	231.6	240.0	257.5	5.0 "	197.5	3.30 "	
24	240.0	234.6	235.5	230.5	236.1	238.0	236.5	202.5	219.0	251.1	237.6	284.5	285.0	276.0	251.5	223.5	217.0	212.5	219.0	215.1	221.5	224.5	228.0	230.5	236.5	328.0+	11.36 "	165.3	7.13 a.m.	
25	236.5	230.1	221.1	217.5	228.0	251.5	308.1	297.0	328.0+	328.0+	315.6	328.0+	328.0+	248.5	243.0	229.0	196.5	214.0	209.1	187.0	189.6	199.5	212.1	220.5	237.2	328.0+	8-12 "	181.0	7.30 p.m.	
26	237.2	250.5	242.1	263.5	266.5	266.1	261.0	284.1	293.1	291.6	288.4	286.5	295.5	270.6	248.1	238.0	240.6	248.1	239.1	220.5	228.0	227.1	236.1	229.0	230.1	310.0	9.10 "	207.4	7.3 "	
27	230.1	226.0	247.5	242.1	258.0	288.6	296.5	284.1	309.0	320.5	320.1	294.6	304.0	235.5	285.0	200.1	202.5	188.1	162.0	195.0	194.1	208.0	228.6	240.6	229.5	328.0+	8-11 "	146.5	5.43 "	
28	229.5	239.1	257.5	295.5	281.1	275.1	287.1	271.0	326.5	324.0	285.6	275.5	264.0	233.1	231.6	225.6	204.0	193.5	172.0	185.1	193.5	211.5	233.5	240.6	247.0	328.0+	8-10 "	147.3	5.50 "	
29	247.0	237.6	238.5	245.5	257.5	275.5	274.5	321.6	328.0+	328.0+	308.5	277.5	273.0	269.5	257.1	230.5	220.0	208.0	196.5	198.6	205.5	217.0	219.0	225.6	224.5	328.0+	7-10 "	172.0	5.48 "	
30	224.5	231.6	240.0	251.5	275.5	321.0	328.0+	328.0+	c	c	c	286.8	307.4	232.0	273.6	258.6	249.0	238.0	207.6	167.5	109.0	153.0	189.0	260.1	255.6	328.0+	6-8 "	40.9	8.23 "	
31	255.6	247.5	253.0	273.6	279.0	293.1	328.0+	328.0+	328.0+	328.0+	328.0+	328.0+	328.0+	319.0	289.0	255.6	194.1	174.1	161.5	144.0	126.0	135.6	109.5	146.1	212.0	328.0+	6-8 a.m. to Noon	59.5	9.45 "	

HOURLY VALUES.

DECLINATION, NOVEMBER, 1902.

D = 150° +																													
Day.	Midt.	Forenoon.										Noon.	Afternoon.										Midt.	Maximum reading and time.		Minimum reading and time.			
		0.	1.	2.	3.	4.	5.	6.	7.	8.	9.		10.	11.	12.	1.	2.	3.	4.	5.	6.	7.						8.	9.
1	154.1	139.1	185.6	221.6	235.5	270.0+	270.0+	270.0+	270.0+	270.0+	270.0+	152.3	142.5	119.0	102.5	102.9	107.0	130.5	141.8	144.6	147.0	178.2	187.4	192.3	270.0+	5-11 a.m.	77.0	0.32 a.m.	
2	192.3	191.6	179.9	179.1	174.5	188.6	207.8	229.5	234.0	210.0	207.6	225.6	201.3	158.6	159.8	155.1	145.4	173.3	172.1	171.5	172.2	178.7	189.0	181.1	191.0	263.3	7.36	187.7	4.20 p.m.
3	191.0	191.0	195.5	192.6	210.2	214.7	231.5	239.1	216.5	172.4	179.0	177.5	169.5	159.2	166.1	146.4	131.7	143.9	138.8	140.7	162.3	165.2	175.8	179.6	185.3	263.3	7.24	130.8	3.37
4	185.3	175.2	174.0	159.5	182.9	177.0	174.5	202.5	193.5	199.1	187.1	171.9	155.6	152.0	144.8	149.9	154.1	151.7	158.3	162.5	168.0	171.6	171.0	166.8	165.5	234.8	8.15	141.6	2.18
5	165.5	160.8	163.1	172.4	172.5	173.6	195.0	184.5	171.6	168.0	168.8	153.5	155.7	152.9	153.8	153.8	154.1	152.9	153.8	148.2	158.3	164.0	172.5	173.6	174.8	203.0	6.15	144.3	7.1
6	174.8	180.8	177.5	181.5	168.8	167.0	189.3	184.5	191.0	190.1	191.6	188.9	187.0	181.1	165.6	157.1	150.5	153.3	149.3	153.5	156.5	171.0	174.9	177.0	187.1	202.5	9.2	141.2	5.43
7	187.1	186.5	188.0	170.6	189.0	222.5	268.5+	268.5+	268.5+	268.5+	261.0	b	245.0	217.1	170.1	127.1	131.4	148.5	166.5	160.4	170.6	176.4	178.5	180.5	175.1	268.5+	6-10	116.7	3.23
8	175.1	176.9	175.5	174.0	174.8	168.0	181.8	209.6	218.4	224.6	174.2	165.0	148.8	171.5	156.3	146.0	150.9	142.8	138.6	141.6	154.1	156.3	168.3	179.9	186.5	249.0	9.18	123.0	5.34
9	186.5	186.0	196.1	185.9	195.5	187.8	194.7	225.0	222.8	203.0	194.9	177.0	167.0	161.4	158.7	145.7	142.2	154.1	163.5	168.8	162.8	170.0	163.1	173.0	172.1	240.0	7.17	138.9	4.25
10	172.1	172.1	179.4	195.5	195.0	200.6	192.5	202.3	239.9	258.0	230.1	216.0	213.5	216.2	192.0	187.2	171.5	164.6	143.7	145.1	146.0	161.9	168.8	171.6	166.1	264.0	8.42	137.0	6.5
11	166.1	169.1	160.2	182.7	185.9	189.3	202.2	179.0	175.5	208.5	182.0	a	a	a	168.8	158.3	161.0	155.3	154.1	162.5	164.7	167.4	178.1	183.5	178.5	230.4	9.26	151.8	2.30 a.m.
12	178.5	187.7	186.2	186.2	182.9	181.8	192.5	231.0	229.5	a	a	a	179.0	168.2	158.7	150.5	148.2	145.8	149.6	150.3	149.0	152.0	149.9	150.0	159.5	252.0	6.50	139.1	4.30 p.m.
13	159.5	155.9	165.0	149.7	167.9	150.2	141.0	150.8	154.4	160.1	171.0	a	a	a	a	a	a	131.6	160.7	158.6	165.0	150.6	154.1	161.0	196.5	10.23	77.3	7.3 a.m.	
14	161.0	186.5	194.7	179.7	190.8	200.6	230.0	219.0	211.1	224.3	211.4	203.3	195.0	200.9	180.8	173.3	161.0	155.7	138.5	122.6	141.5	138.0	170.6	168.0	185.7	261.0	4.44	108.0	6.45 p.m.
15	185.7	170.0	214.5	236.9	202.5	86.0	83.0	65.6	108.9	140.6	104.6	118.8	139.1	118.7	112.4	111.3	108.6	114.0	113.9	117.3	132.9	146.6	162.6	145.1	168.6	255.0	2.30	28.8	7.6 a.m.
16	168.6	159.0	164.6	182.6	131.6	157.1	142.5	91.5	167.0	137.9	207.5	178.7	155.3	130.2	121.7	119.7	119.0	105.0	122.1	134.0	138.0	136.2	150.0	140.0	158.0	232.5	9.45	42.0	6.45
17	158.0	179.0	169.1	158.0	154.5	165.5	141.0	202.8	218.7	144.6	154.1	200.3	190.5	171.9	141.6	190.1	170.1	157.7	151.5	156.9	159.5	167.4	173.9	174.0	178.2	256.5	8.25	109.7	9.25
18	178.2	169.4	168.6	161.1	168.6	139.5	167.1	166.8	160.1	167.7	198.3	171.8	156.0	149.7	141.2	129.3	149.7	151.7	154.8	157.2	170.9	175.5	182.6	179.4	180.5	207.0	10.22	117.0	5.5
19	180.5	183.0	183.5	208.1	208.5	201.5	204.0	194.3	197.1	207.8	200.0	142.7	149.1	189.6	186.3	158.6	127.2	105.5	113.1	138.9	156.9	169.1	131.6	154.8	152.0	256.5	9.21	85.5	5.22 p.m.
20	152.0	161.4	159.2	158.0	145.5	149.0	146.0	128.6	184.1	174.0	166.5	169.2	146.1	152.3	135.6	121.2	128.9	131.6	127.1	140.0	154.1	162.9	176.9	169.2	170.9	195.0	7.35	104.1	7.15 a.m.
21	170.9	170.0	178.1	165.6	198.9	186.6	137.0	131.7	159.3	243.0	229.2	226.7	226.1	210.2	210.9	193.1	167.4	154.1	148.4	152.1	145.1	141.2	151.8	158.3	175.5	261.3	8.52	95.9	6.50
22	175.5	168.0	190.5	161.7	233.3	243.8	206.0	184.5	292.8	223.1	160.1	132.0	190.7	130.8	184.5	161.7	158.0	159.3	132.3	128.7	115.5	119.1	132.5	131.0	142.8	300.0+	8.0	49.5	6.55
23	142.8	157.1	166.1	211.5	236.0	232.1	225.5	246.5	254.3	273.8	265.5	231.0	209.6	168.8	173.6	149.6	161.4	173.9	154.2	98.1	216.1	103.8	98.7	128.0	195.8	298.5+	7.50	75.0	10.35 p.m.
24	195.8	220.5	216.0	158.1	116.6	196.8	170.6	201.0	255.0	298.5+	298.5+	298.5+	252.0	189.0	240.0	112.1	78.6	64.7	92.6	71.3	48.0	47.0	69.3	72.2	127.8	298.5+	9-11	4.5	8.40
25	127.8	171.0	165.5	190.5	241.1	222.0	246.2	285.6	293.6	282.5	295.5	228.8	195.6	188.1	158.0	154.7	152.0	87.6	107.0	103.5	75.3	77.6	85.1	97.5	131.0	298.5+	8.40	46.5	8.26
26	131.0	130.1	161.0	188.7	215.6	237.6	298.5+	298.5+	298.5+	267.9	298.5+	270.0	259.7	239.0	200.1	159.5	114.0	123.3	134.6	129.6	124.5	143.6	158.6	181.8	169.2	298.5+	6-8	102.8	4.10
27	169.2	142.7	142.7	188.1	196.3	208.5	170.6	171.0	189.8	193.1	204.0	154.5	167.0	179.0	173.6	159.2	151.2	137.0	128.0	140.4	142.1	154.1	162.3	136.1	141.2	243.8	9.45	85.5	1.25 a.m.
28	141.2	151.5	154.1	159.0	168.0	165.0	174.8	152.0	178.7	170.3	236.0	175.5	144.5	175.4	190.1	147.5	144.5	149.6	120.0	115.1	121.0	120.8	135.8	142.1	154.2	253.5	10.10	98.0	6.43 p.m.
29	154.2	174.6	168.0	162.0	184.5	176.9	180.2	200.0	209.6	220.1	207.6	195.8	186.6	206.9	164.0	147.9	144.8	150.5	159.3	140.1	141.8	140.3	144.2	149.6	163.7	237.0	8.17	127.5	7.53
30	163.7	178.1	167.1	166.1	164.3	150.5	169.1	190.8	202.5	183.0	152.4	131.3	139.7	117.0	115.1	113.6	105.3	108.9	113.6	124.5	121.8	120.5	112.7	128.6	137.4	216.0	8.1	91.5	4.23

DECLINATION, DECEMBER, 1902.

D = 150° +

Day.	Forenoon.												Afternoon.												Maximum reading and time.	Minimum reading and time.			
	Midt.												Midt.																
	0.	1.	2.	3.	4.	5.	6.	7.	8.	9.	10.	11.	12.	1.	2.	3.	4.	5.	6.	7.	8.	9.	10.	11.			12.		
1	163.4	171.4	165.8	161.5	203.2	198.5	190.6	215.9	212.5	216.1	214.0	197.0	192.5	169.1	178.0	188.9	175.9	147.7	138.1	150.1	166.0	161.3	172.9	173.5	184.7	270.5	9.30 a.m.	120.5	5.37 p.m.
2	184.7	192.8	236.5	265.0	276.5	302.5	298.0	276.8	249.1	283.6	284.0	252.1	156.7	158.2	139.7	115.6	103.3	134.6	151.0	181.9	153.2	143.5	147.5	145.0	151.7	326.0+	6.5	87.2	3.55
3	151.7	152.5	181.6	220.6	228.1	252.8	231.7	235.4	271.6	260.0	219.1	167.8	138.5	138.2	139.0	140.8	133.0	149.5	136.1	118.7	149.5	151.4	188.0	177.5	178.0	294.5	8.55	107.5	6.14
4	178.0	188.8	192.4	217.0	193.0	187.0	206.5	237.7	280.6	271.1	264.8	227.3	210.8	180.5	181.3	157.9	136.0	152.9	165.1	166.7	160.6	156.1	161.3	157.1	170.3	326.0	7.22	130.7	4.17
5	170.3	176.3	172.0	160.6	180.4	197.5	189.1	172.0	185.0	171.7	163.0	163.6	149.6	135.1	132.2	131.3	141.4	136.3	146.9	135.5	136.3	132.2	138.5	146.3	161.5	224.8	8.30	111.5	2.26
6	161.5	159.2	164.3	157.4	176.9	150.2	126.1	215.8	211.0	204.1	160.0	159.5	142.0	162.5	154.4	166.7	142.7	140.5	148.0	131.9	156.7	149.5	141.7	146.6	143.8	267.5	8.45	92.0	5.40 a.m.
7	143.8	151.9	152.5	158.3	141.2	157.3	205.6	194.8	205.6	202.0	189.4	179.3	170.8	165.8	149.5	137.2	147.1	136.6	136.6	141.1	137.3	142.0	145.3	163.0	171.5	234.5	8.15	131.9	5.15 p.m.
8	171.5	163.6	140.9	148.6	178.6	161.8	159.5	197.2	267.5	179.9	149.5	143.0	146.0	165.1	146.2	118.9	125.5	133.6	144.1	147.4	147.1	165.5	179.6	184.4	179.6	299.6	7.57	73.7	9.30 a.m.
9	179.6	167.6	170.2	180.1	181.6	143.2	111.5	197.2	206.2	184.0	229.6	201.5	187.6	184.1	157.1	137.0	146.9	143.0	134.3	149.0	154.9	120.1	122.0	128.5	144.2	252.5	9.55	78.8	6.14
10	144.2	156.8	206.0	168.2	181.0	243.8	117.5	167.0	78.5	307.0	237.1	220.0	232.6	206.0	162.1	153.5	150.5	117.5	136.0	136.9	122.8	116.2	125.5	133.3	185.0	324.5+	9.10	30.5-	8.10
11	185.0	193.0	206.0	184.7	173.3	177.1	272.3	174.7	256.6	247.0	228.7	215.5	216.5	202.1	192.7	174.5	153.7	151.6	152.5	148.3	136.6	139.3	140.9	156.8	151.0	311.0	6.20	111.2	4.44
12	151.0	159.2	127.0	109.4	149.0	160.0	134.5	178.0	127.6	186.1	155.8	163.3	183.4	146.0	117.5	127.0	156.1	123.1	111.4	132.1	147.5	156.7	166.0	172.9	172.0	234.8	9.37	77.0	2.49
13	172.0	147.1	145.0	109.3	167.0	217.6	157.6	90.8	215.5	257.5	219.5	196.6	182.5	109.9	93.5	101.5	123.1	147.8	132.4	146.8	147.4	136.1	118.6	129.5	144.5	279.5	8.54	53.0	7.22
14	144.5	148.3	144.7	146.2	181.6	163.6	160.0	123.4	130.3	133.1	177.5	122.0	161.0	135.4	145.6	135.5	144.5	136.7	140.3	139.4	151.1	161.8	169.0	145.0	148.7	236.0	10.12	84.2	8.52
15	148.7	152.8	141.4	136.0	123.2	139.6	179.8	169.1	164.8	158.0	242.5	175.3	219.5	194.0	138.5	110.2	113.5	120.2	126.7	129.8	134.6	130.1	124.1	125.5	137.8	269.3	0.7	98.0	2.49 p.m.
16	137.8	151.6	183.5	191.3	133.3	100.6	145.6	130.6	207.1	183.8	167.2	159.5	117.7	137.2	137.8	138.2	145.7	137.2	136.4	142.0	142.3	151.0	117.7	132.5	143.5	249.5	8.1	68.5	5.2 a.m.
17	143.5	143.5	144.2	168.5	215.3	255.5	214.3	228.5	180.1	177.7	157.9	115.6	133.3	130.0	144.4	138.5	134.0	138.1	132.2	135.8	136.6	151.7	153.5	153.5	152.5	282.5	5.1	97.3	11.3
18	152.5	152.5	152.0	152.5	148.0	170.6	167.3	173.8	173.2	163.9	161.2	149.3	144.1	137.2	122.6	119.3	122.5	125.2	119.9	126.5	127.9	126.4	131.0	139.6	131.8	200.0	8.25	111.2	1.58 p.m.
19	131.8	131.3	125.9	127.4	128.0	198.7	189.4	214.4	216.1	211.4	211.7	b	152.0	214.6	148.4	135.8	108.5	99.1	95.8	111.5	115.9	117.7	135.2	158.5	168.2	230.0	0.49	81.8	5.27
20	168.2	135.5	159.8	166.6	179.6	204.1	192.8	209.2	192.5	228.1	209.5	170.8	179.3	209.9	187.0	144.8	146.9	130.4	140.3	138.1	148.4	143.8	146.9	164.6	166.1	258.5	7.19	104.2	0.53 a.m.
21	166.1	172.3	196.6	199.3	185.5	188.0	194.8	211.3	221.6	222.5	209.0	194.0	189.1	177.2	178.7	152.0	131.3	140.8	142.0	140.5	145.9	150.7	145.7	152.6	140.0	242.0	9.45	128.0	4.2 p.m.
22	140.0	124.4	116.9	112.6	98.0	104.8	104.5	133.6	226.0	245.6	184.0	140.0	150.2	136.9	151.6	164.0	164.9	157.4	160.3	140.5	118.7	146.3	162.2	162.4	172.9	296.0	7.55	48.5	6.16 a.m.
23	172.9	137.0	210.4	214.0	196.6	221.5	248.3	284.5	314.5	259.0	278.5	279.2	260.2	239.5	253.7	199.7	124.3	123.5	140.5	68.6	87.5	101.0	71.0	100.7	137.8	326.0+	8.0	30.5-	10.25 p.m.
24	137.8	174.1	177.5	184.1	172.4	213.1	252.8	250.9	281.0	241.3	258.5	239.0	230.0	198.1	201.7	138.2	134.2	121.0	122.6	133.9	134.6	123.2	153.1	141.1	162.8	323.0+	7.30	89.3	5.23
25	162.8	156.7	176.2	194.5	176.2	178.6	252.5	247.6	270.7	253.6	228.7	197.5	219.5	219.5	177.5	130.0	116.6	135.2	122.8	116.2	105.5	137.0	139.1	147.8	169.7	293.3	8.26	84.1	6.59
26	169.7	167.0	158.5	157.0	160.6	199.0	223.7	191.2	207.5	185.0	203.5	190.3	168.5	164.0	160.0	159.1	159.2	150.8	144.5	138.7	130.0	127.0	118.7	94.6	127.3	249.5	8.13	76.7	10.32
27	127.3	157.4	182.3	209.8	182.5	165.7	174.8	209.5	283.0	257.0	276.5	230.0	215.0	203.9	159.5	140.9	158.5	133.3	86.5	109.0	88.6	109.9	138.1	155.8	136.0	324.5+	7.37	72.5	6.6
28	136.0	133.7	160.0	154.6	211.0	225.8	255.5	212.0	176.5	214.1	234.5	246.5	229.4	215.6	200.8	176.0	128.1	57.5	130.7	132.5	137.3	147.8	136.0	144.4	152.8	294.5	10.22	27.5-	4.40
29	152.8	143.6	154.4	149.2	162.8	175.5	168.4	174.2	167.5	164.5	152.8	181.3	b	136.6	181.9	180.8	166.1	153.7	154.1	136.0	119.5	132.5	120.1	128.0	148.6	210.5	10.59	105.5	7.57
30	148.6	152.2	146.3	126.4	124.7	138.5	158.0	160.6	169.6	186.8	140.0	123.2	150.4	172.6	175.1	161.6	154.7	149.0	144.7	140.3	130.6	124.4	130.6	152.9	143.5	212.0	8.45	110.8	10.43 a.m.
31	143.5	138.1	144.5	158.5	174.8	177.5	161.3	168.5	155.8	179.9	149.0	(136.8)	124.6	128.0	131.0	123.5	120.1	108.5	108.2	117.4	130.1	135.7	133.0	132.5	121.9	263.0	6.45	103.7	5.17 p.m.

HOURLY VALUES.

DECLINATION, JANUARY, 1903.

D = 150° +

Day.	Midt.	Forenoon.											Noon.	Afternoon.											Midt.	Maximum reading and time.		Minimum reading and time.			
		0.	1.	2.	3.	4.	5.	6.	7.	8.	9.	10.		11.	1.	2.	3.	4.	5.	6.	7.	8.	9.	10.		11.	12.				
1	155.9	152.0	146.1	142.5	134.0	173.1	197.0	194.9	191.9	169.5	153.3	166.5	171.3	195.3	169.8	158.1	156.6	159.6	143.0	135.9	125.6	145.5	170.0	174.8	147.5	249.5	6.16 a.m.	93.0	2.47 a.m.		
2	147.5	128.6	136.1	131.9	221.0	150.5	136.4	175.2	148.1	116.4	120.0	138.0	152.0	113.0	124.7	138.0	166.4	165.9	174.3	176.0	189.8	192.0	181.1	187.2	181.2	255.2	3.50 ..	80.0	9.26 ..		
3	181.2	189.3	210.2	210.5	221.7	218.9	219.3	250.5	283.5	283.1	261.5	258.0	242.3	215.6	176.3	171.3	157.1	178.5	176.0	166.8	167.0	171.8	166.4	166.5	170.0	320.4	8.3 ..	142.5	4.3 p.m.		
4	170.0	157.8	158.9	179.3	175.2	149.4	273.5	260.6	256.5	253.4	255.5	226.5	161.6	131.3	136.7	119.4	104.0	68.6	143.0	126.8	134.6	159.3	172.8	150.2	166.1	300.0	6.50 ..	64.5-	5.10 a.m.		
5	166.1	165.9	161.6	126.5	155.9	119.6	127.8	103.1	128.6	150.3	147.8	137.1	107.3	216.9	256.8	203.0	132.2	152.9	172.4	152.1	96.0	97.1	176.7	158.0	174.5	300.0	1.32 p.m.	64.5-	7.40 ..		
6	174.5	182.0	196.8	205.1	237.8	253.4	171.5	269.3	224.4	244.8	180.8	207.8	221.6	216.0	191.9	173.9	154.1	150.2	147.9	155.1	147.9	146.7	152.6	145.7	151.8	303.0	7.2 a.m.	130.1	11.30 p.m.		
7	151.8	158.4	166.7	193.2	194.9	195.6	228.8	216.8	233.6	251.6	260.9	241.2	210.8	207.3	212.7	202.1	180.0	169.5	147.3	142.1	152.1	153.9	159.0	155.7	184.5	293.3	9.34 ..	122.6	6.45 ..		
8	184.5	183.9	191.3	195.3	195.0	204.8	210.8	183.9	202.7	202.7	208.1	199.8	193.1	175.4	172.1	168.8	172.8	183.6	165.5	167.6	164.0	151.1	138.5	127.4	134.7	238.5	5.50 ..	109.1	11.43 ..		
9	134.7	146.9	140.6	158.3	165.8	140.6	133.5	114.6	105.8	180.8	221.6	207.0	164.1	150.3	153.3	144.0	139.7	134.0	103.7	100.1	140.0	131.4	119.1	127.8	178.4	231.0	10.24 ..	61.8	7.50 a.m.		
10	178.4	187.5	161.0	146.3	231.6	211.2	259.4	154.5	123.5	134.4	114.5	159.0	129.5	157.2	168.0	186.0	176.6	173.7	156.0	167.3	165.6	182.3	157.7	132.2	138.8	301.5	8.52 ..	62.3-	8.30 ..		
11	138.8	148.4	176.9	141.5	137.0	159.3	144.2	156.2	169.1	181.2	144.3	196.1	179.6	218.3	171.9	160.1	132.8	115.5	131.0	138.2	145.4	154.1	148.7	174.0	179.4	322.2	9.6 ..	79.5	8.30 ..		
12	179.4	134.0	164.7	161.9	140.9	187.2	212.6	91.0	121.0	162.8	170.0	125.3	167.0	145.4	134.7	128.9	126.8	128.0	121.4	119.3	119.0	122.0	135.2	146.9	158.7	263.3	5.17 ..	64.5-	7.40 ..		
13	158.7	140.6	173.4	158.6	174.0	155.3	169.1	209.0	195.6	164.9	183.5	192.0	176.3	173.0	177.3	172.1	173.3	164.0	151.4	149.6	145.2	143.0	153.6	146.4	171.9	223.5	7.32 ..	111.0	9.17 ..		
14	171.9	145.4	151.1	160.2	166.1	196.2	260.0	201.5	153.0	189.8	141.0	119.1	135.0	120.2	131.6	111.8	135.9	132.5	153.5	137.3	135.5	133.1	141.8	137.6	144.3	261.6	5.57 ..	93.0	10.23 ..		
15	144.3	150.5	154.5	168.5	134.4	132.0	141.3	172.1	182.6	177.5	165.6	158.7	143.6	146.0	121.7	115.5	95.6	88.2	102.6	97.7	112.2	125.1	136.5	128.3	146.7	204.0	9.44 ..	84.0	4.40 p.m.		
16	146.7	138.0	151.5	169.4	146.3	135.5	155.1	134.4	139.2	135.5	134.7	137.7	139.2	114.5	127.1	140.9	127.8	115.1	103.7	110.9	108.0	119.7	116.1	137.9	147.5	202.2	3.10 ..	89.3	8.9 ..		
17	147.5	156.8	157.4	128.6	a	a	a	a	a	a	a	a	168.2	178.8	125.3	115.4	118.8	119.9	123.9	120.3	107.3	123.5	157.7	168.8	180.3	207.0	0.40 p.m.	98.3	7.38 ..		
18	180.3	181.2	187.1	193.5	173.1	193.5	226.2	210.3	198.0	179.0	174.0	a	a	a	a	a	a	a	a	a	a	a	a	a	a	236.3	5.32 a.m.	145.5	10.45 a.m.		
19	a	a	a	a	a	a	a	a	a	a	a	a	a	a	a	a	a	a	a	143.9	145.2	122.9	124.8	149.4	173.7	188.3	11.36 p.m.	92.3	9.25 p.m.		
20	173.7	192.9	175.2	164.3	227.0	188.6	211.5	255.5	179.3	92.9	175.5	224.3	231.5	243.8	227.3	204.0	182.9	165.0	125.7	130.7	133.2	128.6	156.5	177.3	186.8	295.5	7.34 a.m.	58.5-	8.30 a.m.		
21	186.8	167.3	164.0	158.6	180.3	204.5	240.3	210.3	206.9	220.1	240.0	199.5	146.7	134.0	144.0	150.5	147.8	145.4	132.6	128.9	138.0	148.2	158.6	158.4	159.8	261.0	6.25 ..	101.6	2.36 ..		
22	169.8	157.8	179.4	208.4	208.8	216.9	244.5	278.3	280.4	278.3	273.5	253.2	234.3	183.9	166.1	144.5	147.2	148.5	147.3	145.5	145.2	154.2	157.8	153.0	164.0	299.7	6.43 ..	139.5	3.17 p.m.		
23	164.0	167.3	181.8	182.0	218.0	218.6	212.0	221.6	241.2	256.5	231.3	233.6	214.7	203.0	204.0	208.5	204.3	193.8	176.1	138.5	114.8	156.9	158.0	157.5	172.2	273.0	6.11 ..	95.3	7.59 ..		
24	172.2	145.7	184.8	194.1	189.6	208.7	263.3	205.4	232.7	219.8	221.0	217.5	210.0	182.0	168.0	158.6	162.2	141.5	124.7	128.9	131.1	143.7	156.8	134.7	156.3	319.1	5.38 ..	83.3	1.3 a.m.		
25	156.3	147.9	149.0	178.2	191.6	202.2	213.0	240.6	a	a	a	a	a	a	a	a	a	a	a	a	a	a	a	a	a	266.4	6.40 ..	111.0	0.9 ..		
26	a	a	a	a	a	a	a	a	a	a	a	a	a	a	a	a	a	a	a	a	a	a	a	a	a	a	a	a	a	a	
27	a	a	a	a	a	a	a	a	a	a	a	a	a	177.0	146.6	75.1	74.6	60.0-	63.5	72.9	92.0	91.7	101.4	126.0	147.8	258.0	0.10 p.m.	60.0-	5.0 p.m.		
28	147.8	133.2	153.2	158.3	121.5	145.2	109.4	141.2	128.9	154.1	174.2	a	a	a	a	a	a	a	132.5	129.2	128.4	128.4	116.0	135.5	146.4	214.5	10.12 a.m.	67.5	5.55 a.m.		
29	146.4	137.6	131.6	130.0	136.7	151.5	125.6	120.0	112.4	142.8	178.4	156.6	150.3	150.3	133.5	127.4	110.9	107.4	106.2	113.0	117.5	138.9	155.3	152.0	142.2	204.0	10.4 ..	78.8	7.52 ..		
30	142.2	146.9	147.8	149.3	141.9	158.1	168.5	191.3	201.9	210.3	205.1	206.0	214.1	210.0	190.5	177.9	166.2	137.9	123.5	96.8	65.6	65.0	96.8	116.1	142.5	223.0	11.43 ..	60.0-	9.0 p.m.		
31	142.5	134.4	152.6	154.5	159.5	158.6	149.0	138.8	143.6	169.4	154.4	134.3	135.0	139.1	119.7	123.3	124.2	129.8	138.6	138.6	133.8	136.4	151.4	156.9	134.9	195.0	5.16 ..	112.8	2.18 ..		

DECLINATION, FEBRUARY, 1903.

D = 151° +

Day.	Midt.	Forenoon.												Noon.	Afternoon.												Midt.	Maximum reading and time.		Minimum reading and time.	
		0.	1.	2.	3.	4.	5.	6.	7.	8.	9.	10.	11.		1.	2.	3.	4.	5.	6.	7.	8.	9.	10.	11.	12.					
1	110.9	102.9	123.8	124.2	129.0	130.4	112.4	119.6	108.2	104.0	121.5	96.0	90.0	87.2	86.7	87.0	74.4	94.5	121.2	110.3	117.0	121.1	118.1	127.8	117.2	147.0	5.22 a.m.	58.5	11.7 a.m.		
2	117.2	103.8	107.7	126.8	110.1	145.1	147.3	137.0	143.1	150.0	191.7	161.7	136.2	121.7	120.3	113.7	104.9	98.7	91.1	100.7	116.4	118.5	106.2	107.7	132.5	209.0	9.44	82.5	6.11 p.m.		
3	132.5	124.2	132.2	140.7	84.3	107.9	127.5	168.0	136.7	178.5	202.4	a	a	a	a	a	a	a	96.5	95.6	108.0	100.1	95.1	109.7	130.1	221.4	9.41	42.0	4.22 a.m.		
4	130.1	136.1	136.4	120.5	122.4	119.9	127.5	128.1	138.5	146.7	135.3	145.8	134.6	125.9	132.0	124.8	111.3	a	a	a	a	101.6	99.0	103.5	126.5	161.1	10.43	85.2	4.51 p.m.		
5	126.5	122.6	133.4	144.3	148.1	166.2	191.6	182.4	197.6	203.9	187.2	174.0	150.0	143.9	129.5	82.1	87.2	67.8	58.5	54.3	87.6	75.3	69.5	85.4	102.5	330.0+	8.33	36.0-	6.40		
6	102.5	99.2	89.9	132.5	111.5	109.5	74.0	69.8	99.9	117.6	105.3	115.4	97.1	104.4	112.0	a	82.5	78.8	73.4	74.1	83.0	90.9	98.6	98.1	104.7	145.5	3.56	37.5-	4.18		
7	104.7	118.5	105.8	123.5	136.1	127.2	132.2	135.2	129.6	127.8	137.9	146.4	129.3	125.0	117.8	111.8	98.7	105.0	95.7	92.7	89.3	89.1	80.0	98.6	100.5	160.5	10.42	70.2	9.44		
8	100.5	111.0	119.3	119.0	116.0	110.0	126.5	111.9	114.5	141.3	123.3	123.0	36.0-	72.2	90.5	75.2	72.0	62.9	36.0-	48.0	36.0-	36.0-	43.0	85.2	115.2	160.2	10.50	36.0-	8.9		
9	115.2	107.9	139.1	133.8	145.5	139.5	180.5	283.7	210.0	134.9	98.1	128.6	122.9	a	a	a	a	93.0	92.6	84.5	91.1	86.7	91.4	118.4	117.9	312.0	7.11	50.4	9.45 a.m.		
10	117.9	118.4	121.1	124.1	121.4	133.7	140.0	180.0	165.2	186.3	168.0	165.0	162.2	147.3	145.1	126.9	97.4	75.0	84.0	80.1	92.0	92.3	96.5	94.1	102.9	212.3	9.23	62.3	5.3 p.m.		
11	102.9	112.7	115.1	123.5	109.1	121.5	144.5	164.0	201.0	192.0	187.5	183.8	176.3	163.7	147.9	129.5	100.4	71.7	59.7	66.6	77.9	93.5	100.7	109.5	113.9	255.0	8.1	42.0	6.51		
12	113.9	114.0	128.9	117.2	102.9	134.3	98.0	96.8	96.3	148.2	120.0	117.9	120.5	117.2	93.0	86.6	84.9	92.1	91.4	96.0	97.7	104.3	98.0	106.1	99.3	198.9	8.25	55.5	8.5 a.m.		
13	99.3	104.1	107.7	110.0	103.5	81.5	153.5	255.8	156.0	a	a	a	125.6	147.2	154.2	134.9	153.0	105.0	82.1	101.7	120.0	115.8	107.6	114.3	126.5	324.8	7.30	51.8	6.1		
14	126.5	121.7	126.5	128.9	123.9	114.8	91.1	163.1	163.5	b	186.0	198.0	175.2	155.6	134.7	110.0	87.9	94.7	92.4	104.0	98.6	85.2	92.1	106.2	119.7	237.0	10.32	34.5-	5.47		
15	119.7	98.6	119.6	134.6	126.0	131.9	145.8	145.1	193.5	201.5	184.4	178.5	179.6	161.9	134.3	122.6	103.5	114.3	115.2	108.5	107.1	93.9	103.8	119.3	105.9	217.5	8.46	77.0	9.23 p.m.		
16	105.9	109.1	139.2	148.4	177.8	182.9	145.2	167.0	180.0	191.7	181.2	180.5	162.8	169.8	149.1	124.7	114.3	115.4	113.1	107.4	94.8	107.0	119.0	128.0	126.8	208.5	9.20	82.5	8.21		
17	126.8	129.0	125.9	130.5	147.0	165.5	163.8	183.3	186.0	192.0	194.0	175.8	181.2	165.5	159.0	153.0	122.4	104.1	108.0	106.8	92.9	99.0	102.6	107.0	97.7	209.6	10.15	83.7	8.24		
18	97.7	107.4	130.1	141.5	151.2	146.4	132.0	146.0	158.4	153.5	164.9	160.4	150.9	115.1	91.5	83.4	77.0	71.6	64.5	47.7	75.8	80.3	108.2	115.5	119.0	185.7	9.50	36.0-	7.2		
19	119.0	118.8	123.0	131.6	138.0	146.0	149.1	155.6	168.5	163.4	161.6	155.6	145.1	141.9	126.3	110.9	115.1	111.9	110.4	109.5	89.7	101.6	110.3	119.3	111.2	179.4	8.16	60.0	8.17		
20	111.2	114.9	123.5	122.0	128.3	138.3	142.8	149.0	143.1	186.5	169.8	156.0	154.5	132.9	107.6	87.9	75.6	60.0	53.3	72.2	77.7	84.2	91.4	99.3	126.0	214.1	8.55	44.4	5.36		
21	126.0	115.2	109.4	110.6	109.5	101.0	74.4	112.5	144.6	175.5	176.0	172.2	148.1	116.9	158.0	89.4	107.7	a	a	a	107.1	91.1	97.1	109.2	90.3	198.6	10.23	58.5	5.42 a.m.		
22	90.3	125.0	129.2	127.1	138.0	111.0	143.7	148.2	145.5	124.4	141.0	141.8	130.5	174.6	167.6	115.5	92.0	57.2	34.5-	34.5-	34.5-	53.9	59.9	101.9	108.0	192.9	1.3 p.m.	34.5-	6.8 p.m.		
23	108.0	119.7	117.3	115.1	100.5	98.6	95.4	112.5	107.6	114.2	91.8	62.0	88.1	107.6	84.8	89.6	89.4	85.5	88.5	86.6	88.8	89.1	92.0	102.2	104.9	129.3	1.57 a.m.	36.0	11.25 a.m.		
24	104.9	106.2	101.9	97.1	105.0	112.4	105.5	102.5	111.6	100.7	131.6	123.8	160.1	140.1	119.6	128.0	121.2	105.0	98.1	100.1	102.5	113.0	116.6	115.1	115.8	171.5	11.40	57.8	7.3		
25	115.8	116.7	118.8	118.7	118.1	139.1	138.3	145.2	162.9	167.3	168.8	151.7	157.7	147.3	133.1	156.5	121.1	89.7	61.7	66.8	64.7	87.9	93.3	101.6	122.0	188.1	9.23	50.3	5.34 p.m.		
26	122.0	125.9	140.0	148.2	140.4	131.4	142.2	157.1	156.3	164.6	148.7	135.5	106.2	97.5	82.1	94.5	93.8	96.2	95.1	99.5	104.9	107.6	108.9	111.9	112.1	202.4	7.16	64.5	0.55		
27	112.1	114.5	117.0	116.0	115.1	108.5	105.8	110.7	128.0	122.9	128.6	122.3	127.1	129.3	131.3	118.7	78.6	74.0	84.2	93.5	103.2	108.2	110.7	114.3	116.1	155.1	7.49	45.9	4.25		
28	116.1	119.9	121.8	124.1	127.1	123.9	125.3	137.1	142.2	147.6	149.6	145.1	139.7	119.3	110.1	109.5	106.8	101.0	99.2	99.5	93.2	98.6	115.1	120.0	121.2	152.7	9.47	87.0	8.12		

D 2

HOURLY VALUES.

DECLINATION, MARCH, 1903.

D = 151° +

Day.	Midt.	Forenoon.										Noon.	Afternoon.										Midt.	Maximum reading and time.		Minimum reading and time.			
		0.	1.	2.	3.	4.	5.	6.	7.	8.	9.		10.	11.	12.	1.	2.	3.	4.	5.	6.	7.		8.	9.	10.	11.	12.	
1	108.2	109.3	109.4	114.8	117.7	123.4	131.9	130.0	132.2	123.1	120.2	123.4	107.5	103.6	110.2	98.6	96.4	95.2	86.0	85.0	85.4	86.0	89.9	85.6	89.8	138.8	5.25 a.m.	77.8	10.46 p.m.
2	89.8	98.8	106.0	91.6	122.5	125.5	169.4	150.5	153.1	183.1	146.5	135.8	168.1	140.8	119.8	95.6	104.6	77.0	82.6	63.4	76.3	93.5	95.5	105.8	107.9	222.2	6.32 ..	56.0	7.5 ..
3	107.9	106.4	105.2	101.2	96.5	114.2	116.2	100.6	95.0	109.7	114.5	151.0	145.7	98.5	72.2	78.5	75.2	77.5	88.4	92.5	94.1	101.9	104.2	101.2	108.1	158.0	7.23 ..	53.0	7.58 a.m.
4	108.1	106.0	110.5	109.9	114.4	123.1	131.5	140.3	138.4	138.1	131.8	123.8	103.0	115.3	99.8	97.9	96.1	93.4	89.3	93.8	92.8	92.9	99.1	102.4	98.0	157.4	6.29 ..	81.5	5.57 p.m.
5	98.0	100.9	100.4	107.9	108.7	111.7	113.6	118.6	124.1	153.7	130.6	127.6	113.0	76.1	74.5	76.3	71.9	52.9	65.5	64.3	67.9	65.3	77.8	66.4	99.8	174.5	8.37 ..	34.3	4.55 ..
6	99.8	92.0	107.8	147.8	113.6	103.0	103.3	95.3	107.0	87.1	77.9	93.2	83.3	73.9	68.0	68.3	80.0	83.6	84.8	88.3	88.3	92.3	93.7	94.4	97.6	202.1	3.10 ..	59.0	7.4 a.m.
7	97.6	98.5	103.0	106.6	111.1	108.5	130.3	121.1	109.6	109.0	113.5	98.3	112.6	91.6	60.1	66.8	41.3	44.8	58.0	18.5	39.5	46.7	60.8	70.6	94.3	152.8	6.33 ..	18.5	7.0 p.m.
8	94.3	107.2	106.4	124.1	128.2	140.9	138.1	134.5	131.3	128.3	127.4	98.0	111.8	104.8	69.1	73.4	65.0	91.9	89.5	85.0	86.3	81.4	81.8	84.5	101.2	161.5	6.54 ..	42.5	3.47 ..
9	101.2	94.1	113.2	111.2	119.5	140.9	147.1	173.5	189.1	157.3	149.6	113.5	89.0	98.5	81.8	63.1	64.7	60.5	45.0	72.8	88.3	89.9	95.9	96.2	102.5	224.0	8.1 ..	20.0	5.40 ..
10	102.5	103.4	105.4	105.2	105.1	96.1	107.9	109.4	126.2	102.2	94.0	85.9	76.6	88.1	86.0	82.9	90.5	82.1	84.7	83.0	81.1	89.2	93.4	100.0	102.4	170.9	8.26 ..	69.5	11.54 a.m.
11	102.4	90.1	106.4	110.5	102.1	121.7	122.9	127.1	127.7	107.0	111.5	110.0	107.0	97.1	85.6	83.9	83.0	85.6	80.5	75.8	81.1	84.1	86.6	101.8	91.7	155.6	9.21 ..	62.0	7.10 p.m.
12	91.7	104.3	104.5	107.6	105.5	124.3	125.2	123.2	122.5	112.7	100.0	106.7	97.3	94.0	84.4	74.5	77.9	59.6	60.5	84.1	86.3	83.9	96.1	90.8	96.4	159.5	7.1 ..	47.0	5.25 ..
13	96.4	94.0	101.5	93.5	116.5	128.8	133.0	134.2	124.0	178.0	169.1	161.8	130.9	136.9	147.1	112.0	107.0	90.4	86.0	68.8	83.5	91.3	95.3	99.1	88.6	258.8	9.32 ..	56.8	3.13 a.m.
14	88.6	103.0	98.8	135.5	159.1	151.9	155.2	174.5	119.8	130.0	165.1	133.6	153.8	110.9	98.0	88.0	89.3	90.2	94.6	91.6	92.0	86.8	92.9	101.2	100.1	220.0	7.17 ..	65.0	11.30 p.m.
15	100.1	99.2	101.3	106.3	117.7	120.5	137.6	143.8	136.7	138.2	135.8	131.2	121.0	126.2	124.7	113.5	91.0	91.3	91.4	82.4	73.6	93.8	97.0	92.6	102.1	158.0	8.20 ..	62.0	8.2 ..
16	102.1	100.3	114.4	119.5	114.2	129.5	145.6	130.9	130.9	138.4	133.6	130.6	124.4	112.9	106.4	107.3	98.0	91.1	91.7	82.0	83.5	93.5	101.9	100.3	104.5	166.4	6.33 ..	74.0	7.11 ..
17	104.5	103.6	103.9	104.2	107.5	107.5	114.5	123.3	125.3	122.6	120.5	116.0	114.7	108.2	102.4	95.3	89.3	92.2	91.6	92.5	96.4	96.8	99.5	100.6	102.1	137.0	8.6 ..	89.0	3.38 ..
18	102.1	102.5	105.5	105.1	107.5	109.6	116.8	122.0	123.4	119.3	117.8	121.3	115.7	108.8	91.0	88.3	92.6	94.3	91.6	88.4	92.3	94.4	97.6	99.4	100.9	132.5	7.34 ..	81.1	6.36 ..
19	100.9	102.7	101.6	106.0	108.2	109.1	110.5	125.3	138.4	144.7	150.4	145.7	130.3	108.1	97.0	95.3	93.1	94.1	89.2	61.0	80.6	81.7	82.4	95.8	100.6	171.5	8.43 ..	54.5	6.45 ..
20	100.6	105.8	97.7	105.7	109.0	123.2	127.9	124.6	140.0	145.6	133.0	133.0	96.5	93.1	90.7	82.6	78.5	75.5	72.7	44.0	51.5	75.8	84.2	98.5	104.6	173.0	8.55 ..	23.0	7.10 ..
21	104.6	105.5	103.4	104.5	105.8	111.5	119.9	124.6	140.3	128.3	129.1	128.3	105.7	93.7	90.1	76.3	67.3	58.6	70.6	89.5	94.6	99.5	103.9	100.7	100.9	165.1	7.48 ..	49.3	5.30 ..
22	100.9	109.9	111.7	107.0	108.1	110.3	124.7	130.4	154.7	125.8	111.4	96.8	99.4	98.6	93.8	88.4	81.5	82.6	88.6	96.7	100.6	100.1	105.8	104.3	101.6	165.5	8.26 ..	74.0	4.39 ..
23	101.6	106.4	94.4	109.4	115.6	112.1	124.7	158.8	c	178.3	184.1	a	a	101.9	78.7	78.8	96.5	103.1	105.7	101.2	100.4	96.1	104.2	99.1	102.4	200.8	7.30 ..	65.0	2.45 ..
24	102.4	109.6	108.4	109.0	113.0	112.3	118.0	133.6	142.4	149.3	163.4	134.8	140.9	134.5	111.5	105.7	106.0	102.8	80.8	95.3	90.5	83.5	96.1	109.6	110.2	171.5	9.38 ..	68.9	5.54 ..
25	110.2	112.4	108.5	109.1	110.9	112.3	112.9	113.8	124.3	127.4	129.1	122.5	118.0	109.7	111.7	103.7	102.7	101.0	101.5	100.4	101.5	104.3	106.9	106.7	105.8	137.9	9.45 ..	94.7	5.30 ..
26	105.8	109.4	109.9	110.8	112.1	111.5	110.9	116.2	121.1	127.0	130.1	124.9	120.1	116.0	108.1	106.6	101.0	100.4	96.7	100.7	103.1	103.3	104.3	109.1	109.9	140.6	8.45 ..	94.3	6.25 ..
27	109.9	106.7	111.4	114.7	116.9	118.7	122.2	124.7	120.8	119.9	124.7	125.0	107.0	97.0	95.6	97.0	101.0	100.4	102.7	103.6	103.1	105.7	107.9	109.0	107.3	129.5	7.53 ..	89.9	0.55 ..
28	107.3	109.6	108.8	112.4	113.8	115.0	117.4	126.1	121.0	114.4	110.8	105.5	96.8	97.6	98.2	94.1	94.0	95.8	97.7	101.5	101.8	101.9	104.9	108.1	113.9	132.8	6.56 ..	90.1	3.13 ..
29	113.9	110.2	111.7	113.5	110.5	115.3	114.2	119.8	118.6	122.5	120.2	102.8	97.0	105.1	93.2	91.6	73.1	80.5	78.7	71.2	76.3	106.0	112.0	112.1	107.8	129.8	9.22 ..	58.4	6.5 ..
30	107.8	106.7	108.8	127.0	144.7	146.5	145.1	139.0	117.2	134.9	131.3	136.4	131.2	107.5	82.0	81.2	84.5	85.4	98.3	98.6	93.2	72.1	106.3	108.1	115.6	159.5	6.36 ..	54.5	8.46 ..
31	115.6	112.6	112.4	113.5	119.2	118.9	129.8	141.8	150.5	146.0	173.9	158.5	178.9	130.4	109.6	92.5	89.0	85.7	65.3	82.7	94.6	98.5	96.8	106.4	105.7	220.3	0.3 p.m.	38.0	6.1 ..

DECLINATION, APRIL, 1903.

D = 150° +

Day.	Midt.	Forenoon.										Noon.	Afternoon.										Midt.	Maximum reading and time.		Minimum reading and time.				
		0.	1.	2.	3.	4.	5.	6.	7.	8.	9.		10.	11.	12.	1.	2.	3.	4.	5.	6.	7.		8.	9.	10.	11.	12.		
1	123.7	127.0	130.0	150.1	144.8	139.0	139.3	136.9	150.5	157.0	142.9	133.3	111.2	118.3	134.5	116.0	99.4	107.5	105.1	103.0	115.3	118.7	117.2	120.2	116.0	185.5	8.59 a.m.	85.4	3.56 p.m.	
2	116.0	120.4	134.5	128.3	131.5	130.0	135.5	135.4	138.1	146.0	175.6	166.6	141.1	135.2	135.1	112.4	111.5	114.1	96.7	91.1	82.0	108.2	113.5	120.4	125.3	186.2	10.19	75.5	7.56	
3	125.3	131.0	130.9	130.4	132.1	144.1	168.8	152.2	158.0	151.0	135.5	170.5	134.0	129.2	115.3	109.6	109.3	111.8	111.5	117.4	121.0	119.6	117.1	123.2	119.8	182.0	11.22	105.1	3.2	
4	119.8	126.1	125.9	124.6	128.6	129.4	137.5	146.2	139.6	130.6	130.6	131.8	132.4	120.4	113.3	111.7	99.2	101.3	102.5	103.7	106.6	110.6	124.4	123.7	117.1	156.5	8.15	80.8	4.28	
5	117.1	128.9	131.2	135.4	134.8	137.5	152.5	126.5	152.0	153.8	165.1	147.8	137.6	123.5	109.3	94.4	93.8	104.6	72.2	93.1	120.8	108.8	129.5	127.9	131.5	197.0	9.32	56.0	5.42	
6	131.5	128.9	168.4	139.7	159.5	145.6	130.6	121.9	128.5	135.4	146.6	172.7	176.5	225.5	168.1	36.5	84.4	128.3	142.9	134.5	72.1	36.5	36.5	36.5	90.5	263.5	0.18 p.m.	36.5	9-11	
7	90.5	160.6	161.0	167.6	178.0	175.9	153.1	143.0	141.1	150.1	159.2	177.1	179.9	167.6	158.0	142.0	138.1	132.2	126.5	109.6	103.0	117.2	131.9	130.3	126.1	205.3	11.11	83.8	7.17	
8	126.1	157.3	125.5	135.4	146.0	158.3	146.5	157.0	155.6	154.6	139.3	153.1	152.3	144.8	144.5	137.3	136.1	131.5	128.6	125.5	124.0	128.5	133.9	132.2	139.0	213.5	9.2 a.m.	103.3	9.25 a.m.	
9	139.0	128.8	133.1	153.4	135.1	141.1	145.6	151.6	137.8	138.5	170.3	194.1	179.3	180.5	134.5	128.0	113.5	41.0	41.0	109.0	77.2	106.6	125.6	137.5	142.3	234.8	11.3	41.0	5-6 p.m.	
10	142.3	143.5	140.0	144.5	165.8	175.9	176.5	191.3	166.1	205.9	207.2	159.2	145.6	142.0	138.5	124.0	131.0	128.3	112.7	115.1	84.5	110.8	124.1	142.6	117.1	253.4	6.40	53.0	7.46	
11	117.1	131.8	161.3	143.5	138.5	149.0	163.1	193.1	192.5	172.3	156.2	143.0	157.7	135.7	125.3	138.1	129.1	121.3	115.4	98.8	105.4	108.1	112.4	143.5	136.4	223.3	6.16	74.0	7.10	
12	136.4	140.0	138.1	134.0	136.6	142.9	142.0	140.0	142.9	172.6	157.6	163.7	168.5	181.6	170.8	144.1	124.0	122.6	133.1	131.9	133.7	134.9	130.1	137.6	137.3	214.0	1.10 p.m.	110.8	4.13	
13	137.3	135.8	133.0	145.3	147.4	150.5	162.5	160.6	172.6	185.0	201.8	176.5	154.3	164.6	140.6	133.1	135.8	116.0	107.8	102.1	121.9	110.2	133.7	140.0	139.7	216.5	9.30 a.m.	82.7	6.35	
14	139.7	133.9	135.5	135.5	135.5	141.7	148.3	158.5	160.4	154.0	154.6	154.0	152.8	141.7	138.2	132.5	130.0	124.9	124.1	121.9	134.6	136.9	133.9	137.0	137.0	172.3	8.18	84.5	6.35	
15	137.6	145.1	139.9	142.0	138.1	138.5	143.5	145.7	151.9	144.8	131.6	139.9	147.8	156.7	151.0	142.9	130.6	128.9	124.0	114.2	81.8	78.1	96.5	105.2	122.0	174.5	10.10	44.8	9.30	
16	122.0	136.7	166.0	174.2	183.1	166.3	171.5	164.6	176.0	144.1	137.9	127.3	140.5	142.7	138.8	136.1	142.0	137.9	134.8	132.8	131.8	135.5	134.3	134.0	136.6	216.8	8.11	98.0	0.3 a.m.	
17	136.6	138.5	140.0	141.2	144.1	146.0	147.2	148.3	147.7	154.1	160.7	157.4	151.0	141.4	132.1	124.3	128.9	131.9	130.6	131.5	132.5	134.9	133.7	139.0	134.0	171.5	10.58	122.0	2.58 p.m.	
18	134.0	133.0	142.0	172.6	167.8	193.0	179.6	153.8	150.4	148.6	150.4	146.3	134.6	126.4	126.1	122.0	122.0	126.8	127.6	126.7	122.3	101.3	91.0	93.1	125.9	215.0	5.36	75.5	10.53	
19	125.9	142.0	122.0	164.9	188.0	194.3	201.5	178.6	176.5	158.3	181.6	183.7	180.5	155.0	133.6	143.8	131.0	113.3	115.9	130.7	135.4	139.4	139.0	139.6	140.0	214.4	5.54	77.0	1.38 a.m.	
20	140.0	139.6	141.8	142.9	142.1	145.7	145.7	144.4	145.0	150.7	158.0	161.3	151.3	137.0	135.1	143.8	136.6	127.3	122.9	119.3	130.0	140.5	142.7	140.5	140.8	170.5	11.16	110.0	5.43 p.m.	
21	140.8	139.0	142.0	143.5	145.0	144.4	146.6	147.2	145.1	155.5	161.3	160.1	154.3	142.4	132.5	126.1	123.1	131.2	124.6	88.9	100.0	126.8	146.2	144.8	144.5	170.0	10.55	62.8	7.1	
22	144.5	144.2	140.0	146.6	148.9	145.6	148.7	149.5	151.9	154.3	146.8	148.7	145.4	141.4	136.1	133.0	135.5	136.6	138.8	139.4	135.5	135.2	142.9	141.8	142.6	174.2	10.35	126.5	8.56	
23	142.6	144.1	143.3	140.8	139.6	141.8	145.4	154.3	159.4	167.2	167.0	151.7	148.7	151.7	133.3	131.3	133.1	132.8	133.0	137.8	130.3	139.7	135.8	136.7	148.0	180.5	8.49	122.0	7.41	
24	148.0	139.6	148.3	145.6	152.2	156.2	154.1	155.5	158.0	155.6	150.1	149.0	146.9	149.9	a	a	a	a	a	a	a	a	a	a	a	a	161.9	8.8	132.5	0.54 a.m.
25	a	a	a	a	a	a	a	a	a	a	a	a	a	a	131.5	133.7	127.4	134.5	129.4	131.5	131.8	129.8	132.2	132.2	148.6	154.3	11.34 p.m.	117.5	10.48 p.m.	
26	148.6	154.1	148.0	147.8	146.3	148.3	148.3	148.6	144.4	151.4	151.7	157.6	139.6	136.1	134.3	133.7	135.1	137.3	136.1	140.5	138.5	140.8	145.4	148.4	149.3	169.4	7.23 a.m.	124.6	0.36	
27	149.3	146.5	145.9	144.1	148.0	150.2	154.1	179.8	213.7	189.2	202.0	207.1	189.1	157.9	a	a	a	a	a	a	a	a	a	a	a	a	243.5	7.48	116.0	2.43 a.m.
28	a	a	a	a	a	a	a	a	a	a	a	a	a	a	a	139.0	117.5	128.9	133.0	138.4	145.7	145.6	147.2	147.2	147.7	149.8	8.13 p.m.	102.5	4.9 p.m.	
29	147.7	151.3	149.5	157.0	154.3	157.4	157.1	154.7	154.3	163.0	162.4	149.3	147.5	142.0	142.7	147.5	139.9	133.9	128.3	132.8	139.7	145.3	144.8	146.9	149.0	168.2	9.10 a.m.	121.1	6.4	
30	149.0	143.5	147.4	155.5	164.9	161.5	154.9	156.5	170.6	179.2	164.8	147.8	142.6	144.7	146.0	142.1	142.6	139.9	145.3	145.3	144.1	145.3	144.7	145.6	149.9	192.5	8.48	127.4	5.7	

HOURLY VALUES.



DECLINATION, MAY, 1903.

D = 149° +

Day.	D = 149° +																								Maximum reading and time.		Minimum reading and time.			
	Midt.	Forenoon.											Noon.	Afternoon.															Midt.	
		0.	1.	2.	3.	4.	5.	6.	7.	8.	9.	10.		11.	12.	1.	2.	3.	4.	5.	6.	7.	8.	9.						10.
1.	167.9	165.1	167.6	182.0	172.6	178.4	173.6	183.1	170.3	172.6	174.2	176.0	175.0	168.5	167.8	184.2	160.6	159.2	148.4	159.5	157.6	161.8	161.8	163.7	165.8	200.5	7.18 a.m.	133.0	5.39 p.m.	
2.	165.8	175.3	166.9	171.5	171.8	171.5	182.0	187.1	189.5	187.6	175.6	168.2	164.9	165.1	161.8	157.7	158.9	154.4	157.7	156.1	157.0	159.8	164.5	168.4	168.8	198.5	8.9 "	149.8	3.36 "	
3.	168.8	167.5	167.0	167.2	168.8	173.9	176.6	192.2	200.6	197.0	199.9	188.0	179.0	166.7	164.9	166.0	165.5	166.1	167.2	166.3	167.2	167.3	168.8	169.3	171.1	211.4	9.38 "	155.0	1.5 "	
4.	171.1	172.1	171.1	172.0	172.0	171.1	170.5	173.2	173.9	168.1	176.2	170.5	180.9	166.3	166.3	165.8	158.6	148.4	141.8	150.7	151.9	162.8	158.2	163.6	161.3	182.9	7.22 "	131.6	5.45 "	
5.	161.3	169.0	169.4	172.7	176.5	176.8	202.1	205.1	222.7	287.0	229.6	224.5	204.4	201.8	179.0	138.1	123.5	129.2	98.9	146.2	152.5	168.1	174.4	169.0	177.7	308.8	8.38 "	85.3	5.59 "	
6.	177.7	172.4	180.7	180.4	180.7	179.8	185.2	193.9	186.5	187.7	190.0	202.6	210.5	199.7	193.1	190.3	184.9	172.7	110.9	112.9	124.3	104.5	85.1	155.0	166.4	226.1	11.35 "	56.0	10.20 "	
7.	166.4	194.0	177.1	197.0	190.0	187.3	194.5	187.4	190.4	214.0	225.1	243.7	180.2	202.9	194.5	170.6	126.2	153.1	149.0	128.2	154.6	144.8	136.1	167.8	147.2	281.5	10.35 "	98.0	6.40 "	
8.	147.2	171.1	184.3	178.7	181.6	197.3	212.3	196.7	170.5	178.4	177.5	181.0	177.8	175.1	174.1	164.5	168.7	167.2	168.4	161.8	162.4	156.4	173.5	166.4	172.4	260.0	6.51 "	142.0	8.7 "	
9.	172.4	172.3	170.5	174.1	179.5	191.5	185.0	199.0	207.8	202.9	192.5	198.1	195.8	174.0	170.3	173.8	163.1	157.1	164.9	165.5	166.0	168.2	166.7	170.6	172.0	261.5	5.55 "	140.6	5.16 "	
10.	172.0	174.7	177.1	179.3	184.7	194.8	189.7	181.1	180.4	178.0	179.8	175.7	169.9	185.5	176.3	173.2	167.5	160.3	163.0	159.2	163.0	171.2	171.4	168.2	175.0	215.0	5.46 "	130.3	6.6 "	
11.	175.0	177.4	174.5	175.9	180.4	183.4	183.8	183.4	185.2	179.5	170.3	171.7	175.4	177.2	174.4	174.7	172.9	171.2	173.2	169.9	168.7	167.5	171.7	172.9	173.6	195.1	6.46 "	158.9	10.45 a.m.	
12.	173.6	177.1	178.6	177.4	176.6	178.0	183.1	182.0	179.2	181.3	179.2	180.7	179.9	176.8	172.6	174.8	172.0	170.5	169.0	170.3	168.4	172.6	175.4	173.3	173.2	188.5	8.6 "	153.5	6.13 p.m.	
13.	173.2	173.9	176.3	178.4	176.6	176.0	180.2	178.0	176.2	180.1	176.8	175.0	174.5	164.9	a	a	a	a	a	a	a	a	a	a	a	193.6	8.39 "	162.8	7.45 a.m.	
14.	a	a	a	a	a	a	a	a	a	a	a	a	a	a	a	a	a	a	a	a	a	a	a	a	a	a	a	a	a	a
15.	a	a	a	a	a	a	a	a	a	a	a	a	a	a	a	a	a	a	a	a	a	a	a	a	a	a	a	a	a	a
16.	a	a	a	a	a	a	a	a	a	a	a	a	a	a	a	a	a	a	a	a	a	a	a	a	a	a	a	a	a	a
17.	a	a	a	a	a	a	a	a	a	a	a	a	a	a	a	a	a	a	a	a	a	a	a	a	a	a	a	a	a	a
18.	a	a	a	a	a	a	a	a	a	a	a	a	a	a	181.6	181.9	177.8	176.3	178.4	174.7	176.2	180.5	180.1	182.9	180.7	186.5	11.34 p.m.	165.5	6.38 p.m.	
19.	180.7	184.0	183.1	183.7	182.6	185.0	183.5	181.7	182.3	183.4	183.1	182.5	182.6	181.9	182.9	181.9	180.2	178.9	174.7	164.9	174.8	173.2	179.6	181.9	178.4	187.7	1.45 a.m.	149.8	7.19 "	
20.	178.4	181.0	188.2	186.4	189.2	184.1	185.0	186.4	183.8	184.0	182.9	184.0	180.1	176.5	179.0	178.9	180.2	179.6	181.1	180.7	180.2	181.6	181.3	182.2	182.8	197.0	3.46 "	173.0	0.25 "	
21.	182.8	182.5	181.4	180.4	181.4	182.2	182.8	186.1	184.1	183.5	180.1	181.6	181.7	184.7	182.2	181.6	173.0	168.5	165.4	169.6	172.3	174.4	182.0	183.7	182.2	193.6	0.58 p.m.	157.6	6.9 "	
22.	182.2	174.2	179.9	192.7	184.4	188.5	186.1	196.6	200.4	a	a	a	179.0	177.8	174.5	171.5	172.3	172.6	164.5	165.1	149.0	173.9	185.2	181.7	185.0	212.0	8.1 a.m.	128.8	8.9 "	
23.	185.0	183.5	183.1	186.4	184.4	190.1	189.5	187.4	184.4	188.5	197.0	a	a	a	a	a	a	a	a	a	a	a	a	a	a	208.4	9.25 "	177.5	8.0 a.m.	
24.	a	a	a	a	a	a	a	a	a	a	a	a	a	a	194.5	182.8	181.1	183.2	182.0	183.2	183.8	184.1	184.4	183.7	183.4	204.8	1.43 p.m.	177.5	3.28 p.m.	
25.	183.4	183.4	183.5	a	a	a	a	a	a	a	a	a	a	a	179.5	171.2	170.0	166.7	166.1	170.5	165.2	145.0	178.9	182.8	176.2	197.0	1.20 "	125.8	8.59 "	
26.	176.2	205.7	192.1	a	a	a	a	a	a	a	a	a	a	a	183.8	177.7	151.4	166.7	173.0	178.4	177.5	182.3	180.7	185.9	182.3	225.5	0.56 a.m.	133.1	4.4 "	
27.	182.3	183.4	a	a	a	a	a	a	a	a	a	a	a	185.0	186.2	185.9	a	a	a	a	a	a	a	a	a	194.0	2.6 p.m.	175.3	2.34 "	
28.	a	a	a	a	a	a	a	a	a	a	a	a	a	192.3	190.3	185.5	167.3	141.5	136.7	144.1	164.2	165.5	185.3	183.8	183.4	202.3	1.16 "	127.1	6.54 "	
29.	183.4	187.0	187.3	185.3	188.3	190.6	191.5	196.9	192.2	198.4	204.1	218.4	a	a	181.4	174.2	176.5	175.6	176.6	164.6	168.8	155.3	166.0	170.3	192.5	219.1	11.4 a.m.	142.4	8.55 "	
30.	192.5	191.2	184.3	184.7	190.0	197.0	202.9	214.0	223.3	223.0	211.0	202.9	195.1	180.4	173.0	176.6	160.9	160.0	148.6	148.6	148.3	151.4	163.0	177.4	186.1	235.9	8.13 "	125.9	7.28 "	
31.	186.1	187.7	193.6	189.8	194.0	197.5	203.9	224.3	215.2	198.8	203.8	208.6	205.0	189.8	178.7	182.2	185.2	185.3	185.0	185.5	185.2	182.2	180.5	187.9	187.0	231.5	6.59 "	170.8	1.31 "	

DECLINATION, JUNE, 1903.

Day.	D = 149° +																								Maximum reading and time.	Minimum reading and time.			
	Midt.	Forenoon.										Noon.	Afternoon.										Midt.						
		0.	1.	2.	3.	4.	5.	6.	7.	8.	9.		10.	11.	12.	1.	2.	3.	4.	5.	6.	7.		8.			9.	10.	11.
1	181.0	186.1	182.6	181.3	181.4	182.8	183.4	183.1	184.3	184.0	183.8	182.8	180.2	181.4	180.5	180.1	180.1	181.1	179.0	175.6	165.2	140.5	137.6	134.0	167.0	191.0	1.10 a.m.	125.6	11.1 p.m.
2	167.0	186.2	176.2	202.4	201.5	225.8	203.0	192.7	186.1	203.0	200.8	212.5	231.2	229.0	218.2	170.2	161.2	147.4	143.8	151.1	153.8	132.8	145.9	162.1	204.1	275.6	8.32 ..	66.5	5.58 ..
3	204.1	158.8	159.7	193.6	209.5	249.1	239.2	215.8	204.5	196.4	207.1	215.6	212.0	193.3	161.3	171.2	188.6	144.2	160.6	176.8	174.1	172.7	178.6	183.8	176.0	283.4	5.8 ..	116.0	5.15 ..
4	176.0	186.7	193.3	209.5	218.5	190.3	182.5	194.5	188.8	196.3	192.5	203.6	188.2	189.5	201.2	180.5	128.0	189.4	192.1	183.7	175.9	174.5	169.3	170.3	170.3	237.8	3.35 ..	86.8	4.10 ..
5	170.3	181.0	179.6	187.4	188.8	191.2	200.5	211.0	231.7	202.7	184.9	202.6	208.9	197.2	184.6	181.7	181.6	175.1	178.1	169.6	148.7	174.5	178.3	183.1	180.4	248.0	8.1 ..	144.5	8.5 ..
6	180.4	186.8	188.8	190.1	186.4	192.1	188.2	186.1	186.7	188.2	185.6	184.0	184.1	185.9	183.1	184.0	181.4	185.6	183.4	183.2	173.5	182.6	186.1	187.0	185.9	204.5	2.30 ..	164.8	7.41 ..
7	185.9	185.0	188.3	186.5	189.4	190.6	187.6	187.7	184.3	184.3	195.1	195.8	196.3	185.5	189.5	191.8	182.0	173.5	173.8	179.9	185.6	185.0	179.5	186.4	187.4	205.0	11.19 ..	159.5	5.36 ..
8	187.4	188.0	182.8	187.0	186.2	190.1	190.1	188.5	187.9	186.2	187.7	186.8	187.3	186.8	188.0	190.4	187.3	182.2	175.6	174.7	a	a	a	a	a	195.5	5.19 ..	163.0	7.43 ..
9	a	a	a	a	a	a	a	a	a	a	a	a	a	a	185.5	180.1	179.2	178.6	173.6	176.0	174.2	183.5	181.6	181.6	175.9	190.3	1.51 p.m.	157.0	6.23 ..
10	175.9	191.8	191.9	185.0	186.2	187.1	188.0	189.1	187.7	194.6	195.8	187.1	187.1	183.8	186.8	182.8	181.4	180.8	178.3	179.3	173.2	182.0	184.4	188.2	189.8	223.0	9.34 a.m.	160.3	0.21 a.m.
11	189.8	185.5	188.3	186.5	188.0	191.0	189.5	194.9	186.2	188.8	187.4	189.1	194.8	186.1	183.5	182.6	177.8	177.5	180.8	180.5	178.7	184.9	184.3	188.0	184.6	209.0	0.14 p.m.	159.5	5.26 p.m.
12	184.6	188.2	188.5	186.1	186.4	188.3	196.0	198.4	189.2	191.2	189.4	187.6	186.1	182.0	184.7	188.3	185.5	179.8	183.1	185.0	183.2	179.2	181.0	184.0	189.1	205.1	6.23 a.m.	170.9	5.14 ..
13	189.1	192.5	186.2	184.1	193.9	210.7	198.7	188.9	189.1	194.8	191.3	193.4	195.1	190.3	185.0	182.5	180.8	178.7	171.7	178.7	179.0	185.0	184.4	185.6	188.2	216.5	5.27 ..	166.0	6.21 ..
14	188.2	190.4	191.3	190.6	192.1	188.3	188.5	188.8	190.6	187.3	188.6	192.1	190.9	186.7	188.2	182.6	181.3	180.7	181.9	187.6	187.0	185.8	180.1	188.0	192.5	201.2	2.43 ..	167.8	6.8 ..
15	192.5	187.7	188.8	189.5	188.2	191.9	190.9	188.6	192.2	191.2	191.5	190.7	187.0	189.1	a	a	a	a	a	a	a	a	a	a	a	195.5	8.20 ..	179.8	2.9 a.m.
16	a	a	a	a	a	a	a	a	a	a	a	a	a	a	188.0	189.8	188.0	187.0	188.2	186.8	188.8	186.5	185.2	180.7	183.5	198.5	11.56 p.m.	173.8	10.33 p.m.
17	183.5	188.6	192.2	189.2	190.6	192.7	198.1	200.3	214.6	238.1	282.7	234.7	198.8	190.3	186.5	164.5	165.7	161.8	173.0	152.8	172.9	179.9	176.9	184.1	181.6	299.0	9.58 a.m.	129.1	6.33 ..
18	181.6	186.7	195.5	193.1	188.3	a	a	a	a	a	a	a	a	a	210.5	187.7	154.4	161.2	167.8	164.3	157.4	172.3	173.3	179.3	183.5	245.8	1.27 p.m.	119.0	3.5 ..
19	183.5	203.9	196.9	194.0	194.0	194.2	192.1	199.1	200.6	196.6	199.4	197.0	194.9	190.4	186.7	175.3	161.0	160.0	145.4	133.3	164.6	190.6	176.3	188.2	189.1	225.5	8.48 a.m.	92.0	7.2 ..
20	189.1	188.3	194.5	210.5	206.5	211.0	220.4	223.4	223.6	213.5	224.2	221.3	204.5	197.5	193.6	184.3	175.9	177.2	175.9	162.5	167.8	185.5	187.4	192.8	190.6	240.8	6.10 ..	128.9	7.15 ..
21	190.6	190.3	204.4	195.8	197.3	199.6	203.5	203.3	202.0	206.8	202.0	192.8	190.4	195.1	192.1	191.5	191.0	190.4	185.0	187.1	187.6	188.9	186.7	183.8	180.1	230.0	7.23 ..	175.3	11.43 ..
22	180.1	208.0	182.5	192.1	198.8	204.5	207.8	221.9	221.5	249.4	232.9	222.7	253.4	225.5	199.7	189.4	180.5	176.3	137.9	160.6	173.5	182.3	191.6	178.3	199.1	286.6	8.59 ..	108.5	6.29 ..
23	199.1	190.0	193.4	231.8	230.5	202.3	210.2	216.1	214.6	196.7	232.3	230.2	196.0	204.8	192.2	179.9	169.0	163.3	157.9	164.0	177.4	155.2	188.0	194.0	189.5	266.0	10.23 ..	140.0	8.46 ..
24	189.5	182.6	191.8	201.1	224.9	210.2	221.2	248.6	254.2	223.4	220.3	226.0	223.3	210.2	204.2	205.0	172.7	141.1	157.6	177.8	155.3	181.7	186.5	199.4	187.1	275.5	7.50 ..	119.0	5.1 ..
25	187.1	199.6	196.4	187.4	197.9	210.4	222.1	209.6	203.8	222.1	228.7	200.9	197.8	196.3	193.3	190.3	186.8	188.8	180.8	171.4	172.0	188.2	187.6	196.7	193.6	236.0	6.25 ..	152.0	7.1 ..
26	193.6	191.3	191.6	193.0	195.1	197.5	201.1	198.5	197.9	203.0	201.5	194.8	192.1	189.8	189.5	191.3	192.8	189.1	183.5	186.1	189.5	192.7	195.1	193.3	192.4	211.1	6.19 ..	172.0	5.56 ..
27	192.4	191.5	191.5	192.5	193.7	196.0	194.5	194.8	195.7	196.1	196.6	195.2	195.2	193.0	193.1	193.3	193.0	193.7	193.9	194.2	194.3	194.2	193.7	194.5	196.3	203.0	9.34 ..	185.9	5.5 a.m.
28	196.3	196.1	196.0	195.5	195.8	196.3	197.2	197.3	196.7	197.0	196.7	196.3	190.3	192.7	195.1	192.7	186.5	180.8	180.4	168.7	97.9	192.2	185.0	187.1	187.7	205.6	11.56 p.m.	44.0	8.3 p.m.
29	187.7	186.2	189.1	197.2	229.0	232.4	227.2	309.4	263.0	211.4	207.1	228.1	200.2	195.1	196.7	193.3	188.8	167.5	155.8	163.4	155.8	131.0	177.8	188.6	173.8	338.0+	7.5 a.m.	67.6	8.42 ..
30	173.8	175.6	193.6	205.3	244.0	221.3	219.1	254.5	273.1	268.0	240.1	199.6	232.3	231.1	241.0	210.1	193.0	184.1	183.2	184.1	167.3	166.9	171.7	172.4	191.5	314.0	8.55 ..	128.8	1.15 a.m.

HOURLY VALUES.

DECLINATION, JULY, 1903.

D = 149° +

Day.	D = 149° +																								Maximum reading and time.		Minimum reading and time.		
	Midt.	Forenoon.											Noon.	Afternoon.															Midt.
	0.	1.	2.	3.	4.	5.	6.	7.	8.	9.	10.	11.	12.	1.	2.	3.	4.	5.	6.	7.	8.	9.	10.	11.	12.				
1	184.5	182.1	192.9	186.0	213.3	261.9	247.0	200.5	237.0	270.9	231.6	205.2	193.3	197.1	204.3	188.5	183.6	178.8	137.4	144.4	188.1	188.2	177.1	176.1	170.4	331.0+	9.20 a.m.	115.0	6.25 p.m.
2	170.4	183.1	200.4	187.9	196.3	201.1	209.5	198.6	206.2	206.2	220.0	207.1	200.8	189.1	203.5	187.3	181.5	169.3	184.0	173.5	183.6	187.5	188.5	189.1	191.8	233.8	5.59 ..	110.5	0.49 a.m.
3	191.8	191.4	189.6	196.5	198.7	198.3	199.0	198.1	207.3	201.0	204.0	194.2	199.3	192.0	191.5	191.5	194.8	174.3	176.5	181.8	181.2	185.8	188.4	190.5	192.4	222.1	10.2 ..	142.5	8.47 ..
4	192.4	194.4	191.1	188.4	193.9	191.5	193.0	189.3	193.5	188.7	191.1	196.5	196.6	192.9	187.9	189.1	187.2	185.2	177.0	176.5	168.0	172.8	179.1	187.5	193.5	206.5	8.14 ..	156.1	7.42 p.m.
5	193.5	194.8	189.1	189.9	189.1	196.8	193.8	191.1	197.1	196.2	186.6	192.0	192.0	184.0	187.6	187.9	187.6	186.6	189.4	189.3	189.3	188.8	189.1	187.3	189.6	213.0	7.8 ..	169.0	7.4 a.m.
6	189.6	191.5	188.8	187.9	186.0	192.9	199.9	214.0	225.6	225.9	279.0	216.3	229.5	220.2	191.4	173.1	157.6	174.3	160.3	109.0	148.0	183.6	168.6	186.0	192.9	300.7	9.26 ..	66.1	7.24 p.m.
7	192.9	197.1	197.4	200.4	199.9	193.6	201.1	192.6	195.6	197.1	192.9	194.8	194.5	192.0	191.4	189.0	183.3	178.8	168.9	173.2	182.7	186.4	188.8	190.9	193.2	235.3	2.24 ..	150.1	5.32 ..
8	193.2	192.3	193.5	196.3	192.0	193.5	196.2	197.5	195.4	199.3	196.5	196.6	194.8	190.5	193.0	189.6	189.3	186.0	190.3	188.8	187.2	189.9	192.0	197.4	192.3	205.0	7.36 ..	181.3	5.0 ..
9	192.3	186.7	189.6	192.6	194.7	196.9	213.0	198.7	192.6	195.7	194.5	202.0	197.8	197.2	197.5	193.5	189.3	191.7	191.7	187.9	174.3	162.4	178.6	183.4	189.6	220.5	6.11 ..	153.1	8.48 ..
10	189.6	194.4	197.2	200.2	196.2	209.7	208.8	203.4	208.2	203.7	214.8	220.2	241.3	200.4	186.6	187.3	198.4	191.8	185.5	184.2	182.5	155.7	151.5	198.7	197.2	257.5	11.38 ..	124.5	9.25 ..
11	197.2	183.6	196.5	251.4	263.7	255.0	224.5	209.8	208.5	193.2	199.3	201.3	207.1	222.4	210.0	194.2	187.0	175.3	189.1	133.9	138.4	173.8	192.6	202.2	202.2	272.8	4.50 ..	113.5	6.55 ..
12	202.2	189.3	206.2	203.8	205.8	202.9	217.0	230.5	219.1	207.7	211.0	203.8	218.2	226.2	219.3	201.0	194.2	193.6	193.2	193.0	185.5	186.9	192.1	197.5	195.1	262.3	6.6 ..	178.0	7.49 ..
13	195.1	200.1	195.0	202.0	198.6	199.6	197.5	200.1	200.8	201.1	201.1	199.2	198.0	199.3	196.5	195.1	197.2	192.3	187.6	173.7	148.8	184.8	192.9	186.4	194.1	209.5	8.25 ..	127.8	7.25 ..
14	194.1	193.9	194.7	194.5	203.1	206.1	195.9	202.6	197.1	212.4	211.0	216.0	210.6	198.0	209.5	198.3	185.1	184.0	175.6	176.2	192.6	196.2	194.7	194.8	191.8	230.8	11.19 ..	156.3	7.19 ..
15	191.8	192.0	208.3	196.5	203.4	202.9	197.7	198.9	204.1	217.5	226.5	226.8	204.7	197.5	194.5	181.5	181.6	188.1	186.6	186.7	184.2	171.3	195.3	197.5	201.4	243.3	10.31 ..	138.7	8.44 ..
16	201.4	197.5	202.0	194.8	196.2	a	a	a	a	a	a	a	a	a	a	a	a	a	a	a	a	a	a	a	a	207.3	0.10 ..	184.0	2.48 a.m.
17	a	a	a	a	a	a	a	a	a	a	a	a	a	a	179.7	181.6	177.6	163.8	171.1	172.8	165.1	182.2	199.2	193.6	191.7	208.0	10.32 p.m.	135.4	7.43 p.m.
18	191.7	197.2	220.2	219.0	214.5	204.7	210.9	196.9	206.5	208.0	202.6	204.6	200.2	195.4	195.0	192.3	170.8	153.3	162.0	202.5	192.6	200.2	193.0	195.9	194.5	232.8	3.35 a.m.	123.1	5.39 ..
19	194.5	200.7	210.9	195.0	207.4	221.1	227.5	231.9	214.5	208.3	217.0	255.4	220.6	198.7	200.5	174.7	168.6	171.3	139.9	126.9	150.6	153.9	177.6	173.1	209.1	284.5	4.10 p.m.	83.5	7.45 ..
20	209.1	209.8	200.4	225.3	280.3	229.2	238.5	230.1	221.5	211.5	205.9	216.6	230.1	201.7	194.1	194.7	194.5	185.4	179.1	188.2	189.4	190.0	190.0	199.3	208.5	321.0	4.0 a.m.	158.5	5.50 ..
21	208.5	197.4	201.4	197.5	200.7	200.2	204.1	211.6	207.9	204.6	212.5	201.9	208.0	205.5	197.8	189.3	159.3	191.5	198.1	189.9	191.1	197.1	201.6	200.7	202.3	222.1	7.27 ..	128.5	3.56 ..
22	202.3	197.4	196.5	204.3	211.8	210.9	205.6	205.6	204.0	205.5	204.1	204.6	202.0	206.2	212.2	202.0	190.2	186.0	195.5	198.9	199.9	200.8	198.6	200.5	206.8	223.5	4.11 ..	171.0	5.6 ..
23	206.8	201.3	201.1	201.1	203.1	210.6	208.6	206.1	206.5	204.9	202.9	202.9	203.1	201.6	200.1	198.9	197.1	195.9	187.0	187.3	194.1	193.6	198.6	199.2	200.7	217.0	6.55 ..	180.0	5.45 ..
24	200.7	204.6	202.3	208.3	212.8	210.6	204.3	215.7	209.1	207.4	207.1	206.5	204.3	208.5	197.8	198.7	198.0	199.9	200.2	200.7	202.2	201.9	202.6	202.8	202.3	250.0	6.24 ..	193.5	6.19 a.m.
25	202.3	201.9	202.0	201.1	202.0	201.3	204.0	203.5	207.0	206.5	207.9	204.4	203.2	199.8	195.6	197.5	192.7	192.6	192.6	190.2	182.2	177.4	184.9	194.1	206.4	213.6	10.43 ..	168.3	8.36 p.m.
26	206.4	205.2	204.1	206.1	216.3	205.6	216.6	208.6	219.1	241.2	238.6	222.0	234.1	212.5	210.0	194.8	194.4	183.7	86.5	191.1	173.2	148.2	134.1	178.2	163.5	280.0	8.5 ..	40.0-	5.57 ..
27	163.5	221.4	219.9	205.6	212.1	223.6	234.1	219.4	241.8	220.5	223.2	241.5	234.6	225.7	207.3	183.7	172.8	161.2	152.2	176.1	189.1	178.5	126.6	186.4	180.1	270.4	7.28 ..	116.5	9.41 ..
28	180.1	194.2	229.5	200.1	210.9	229.0	244.0	220.8	235.0	218.5	218.1	241.0	232.0	156.3	219.0	212.8	204.3	183.1	166.3	151.6	145.0	176.5	182.5	178.8	199.8	300.4	8.10 ..	104.5	6.35 ..
29	199.8	207.3	200.4	208.5	213.7	219.1	216.0	227.4	247.0	260.8	281.1	227.1	211.9	198.0	200.1	203.1	182.5	182.7	189.1	176.4	190.5	199.5	203.1	204.6	206.8	309.3	9.44 ..	156.1	6.24 ..
30	206.8	207.3	207.7	207.7	211.3	213.9	221.2	227.1	237.9	234.4	239.5	231.4	211.0	c	c	c	c	c	c	c	c	c	c	c	c	263.2	10.16 ..	195.3	3.53 a.m.
31	c	c	c	c	c	c	c	c	c	c	c	c	c	c	c	c	c	c	c	c	c	c	c	c	c				

DECLINATION, AUGUST, 1903.

D = 149° +

Day.	Midt.	Forenoon.										Noon.	Afternoon.										Midt.	Maximum reading and time.	Minimum reading and time.				
		0.	1.	2.	3.	4.	5.	6.	7.	8.	9.		10.	11.	12.	1.	2.	3.	4.	5.	6.	7.				8.	9.	10.	11.
1	c	c	c	c	c	c	a	a	a	a	a	a	a	a	200.5	191.5	198.0	190.0	185.1	186.1	194.8	196.6	193.2	191.4	189.1				
2	189.1	189.6	205.5	198.3	205.5	206.7	212.1	204.9	205.2	211.0	208.8	207.9	200.4	193.3	193.0	195.7	194.2	194.1	196.6	194.5	193.0	192.0	196.5	193.0	202.2	228.3	9.33 a.m.	176.1	1.13 a.m.
3	202.2	195.6	201.0	200.8	199.9	202.9	199.3	212.5	202.3	199.6	202.2	197.7	198.6	193.5	197.1	196.5	196.8	193.5	190.5	192.9	194.7	197.5	196.8	196.3	203.4	224.8	7.33 "	178.0	0.35 "
4	203.4	203.5	200.8	200.7	200.4	201.3	201.9	203.8	202.8	199.9	199.2	199.6	196.0	199.6	196.2	193.6	194.5	193.6	187.0	180.0	187.0	176.8	185.5	192.3	193.3	208.3	8.11 "	168.6	9.19 p.m.
5	193.3	203.2	203.7	204.6	212.4	213.0	208.9	218.1	268.3	240.0	241.3	269.5	247.0	243.7	189.4	178.9	196.9	178.9	188.8	199.9	200.4	203.4	201.0	202.8	201.9	285.1	11.55 "	154.8	3.0 "
6	201.9	198.7	204.3	206.5	207.4	207.0	207.1	209.4	206.8	202.8	203.1	207.1	208.3	201.6	201.7	195.1	199.3	198.9	197.7	196.9	178.8	187.9	193.5	195.6	202.5	215.1	7.36 "	169.0	7.59 "
7	202.5	204.3	199.3	207.1	206.4	219.3	220.6	220.2	215.4	213.1	213.6	212.2	210.0	205.8	201.9	200.1	198.6	197.5	197.8	198.1	198.1	199.8	199.0	200.1	197.5	233.8	6.59 "	189.7	7.44 "
8	197.5	201.9	206.5	203.7	204.6	207.0	207.6	207.6	213.7	207.7	208.3	218.8	211.6	216.0	209.1	207.4	193.8	197.7	188.1	192.0	199.3	198.4	201.4	195.7	204.0	233.5	11.29 "	182.2	3.57 "
9	204.0	209.2	213.4	212.2	208.3	216.9	235.6	239.1	222.0	208.3	232.8	211.9	197.5	194.1	195.4	c	c	c	c	c	197.5	196.3	198.0	200.4	198.7	277.2	6.38 "		
10	198.7	206.2	227.2	267.0	232.2	220.8	222.3	216.0	227.8	221.8	223.5	200.2	202.0	209.1	193.6	197.8	c	c	c	c	c	c	a	a	a	320.5	2.28 "		
11	a	a	a	a	a	a	a	a	a	a	a	a	a	c	c	c	c	c	c	c	117.6	158.5	156.0	207.8	171.0				
12	171.0	215.0	222.5	213.0	241.0	323.5+	243.0	210.0	222.0	258.0	239.5	224.2	215.2	c	c	c	c	c	c	c	c	a	a	a	a				
13	a	a	a	a	a	a	a	a	a	a	a	a	a	a	216.7	197.1	212.5	197.5	195.7	191.1	192.6	178.6	175.6	187.8	195.7	251.1	1.22 p.m.	137.5	10.13 p.m.
14	195.7	215.4	206.2	190.8	206.5	230.1	272.8	270.7	264.0	245.5	223.5	247.6	242.4	221.5	188.5	182.6	180.6	186.9	183.9	129.4	138.1	162.7	191.1	188.1	230.1	322.0+	6.56 a.m.	95.5	7.15 "
15	230.1	201.6	200.2	214.6	223.5	226.5	219.1	217.5	283.0	237.7	216.9	210.6	204.3	219.1	204.9	214.6	179.5	189.0	200.2	197.5	184.8	200.4	202.9	204.3	203.1	310.0	8.13 "	125.5	3.35 "
16	203.7	216.3	208.5	211.3	216.0	204.9	216.4	224.7	215.8	209.1	210.0	207.1	212.5	203.1	200.5	195.4	196.0	200.1	197.1	198.3	197.5	200.8	199.5	203.1	203.1	244.0	6.55 "	183.6	6.2 "
17	203.1	211.2	225.3	204.3	209.8	231.3	277.9	269.1	208.6	229.0	202.9	210.3	208.3	212.5	203.5	198.6	192.3	188.1	187.0	184.3	169.5	198.4	208.0	207.3	207.4	295.0	6.8 "	141.4	7.51 "
18	207.4	204.4	208.3	210.9	210.7	211.2	209.5	208.3	210.1	210.4	214.0	216.3	203.5	207.3	197.8	208.9	196.5	180.0	177.7	191.7	187.0	183.9	195.0	198.0	213.9	223.9	11.11 "	148.8	4.54 "
19	213.9	208.5	209.8	212.7	211.5	209.7	217.3	223.0	222.0	212.4	216.0	209.1	204.3	203.2	199.6	198.4	193.0	202.9	200.8	199.3	204.1	204.3	207.3	207.7	210.0	238.5	7.26 "	188.2	4.22 "
20	210.0	209.1	208.0	209.1	212.2	213.7	213.3	214.2	214.3	214.2	217.3	217.2	214.5	208.6	201.9	204.6	196.9	190.2	176.1	177.1	180.3	181.3	203.5	204.7	207.9	221.5	7.9 "	163.0	7.5 "
21	207.9	206.5	225.6	220.3	216.6	218.5	212.1	228.4	250.5	278.4	271.5	249.1	227.7	197.7	191.8	186.4	196.3	198.9	199.2	182.5	166.9	163.9	188.1	213.4	207.9	292.0	9.15 "	144.6	8.35 "
22	207.9	205.0	211.3	211.0	226.5	242.7	262.2	278.7	284.1	323.5+	323.5+	291.1	259.0	205.3	191.5	181.6	32.5-	130.2	191.8	114.7	82.8	114.0	175.3	171.3	222.0	323.5+	10.0 "	32.5-	4.20 "
23	222.0	207.3	225.0	232.0	251.1	227.5	258.4	238.0	272.4	268.5	287.2	242.1	224.2	234.9	228.7	217.5	210.1	201.4	183.7	175.3	111.0	151.9	199.3	188.5	208.6	313.3	8.45 "	62.5	8.3 "
24	208.6	212.8	215.1	214.3	260.8	254.1	231.6	225.6	253.0	254.5	263.5	325.0+	263.8	239.2	198.9	231.3	202.0	174.0	207.1	196.3	203.7	193.5	192.4	201.7	194.1	325.0+	11.0 "	150.1	5.13 "
25	194.1	209.8	223.3	205.8	211.0	217.2	224.8	225.1	231.1	227.5	237.0	223.6	228.1	200.5	218.7	215.2	197.2	177.7	175.2	205.8	206.7	199.0	194.4	197.4	201.0	271.0	9.39 "	145.6	5.42 "
26	201.0	209.2	212.8	207.9	217.0	236.2	225.3	221.2	221.2	242.2	254.8	322.0+	276.9	262.0	226.5	203.2	208.2	195.0	164.4	32.5-	85.3	130.0	161.2	175.2	188.4	322.0+	11.0 "	32.5-	7.0 "
27	188.4	199.0	239.8	220.6	241.9	254.2	278.7	269.5	271.0	262.5	293.7	291.0	274.0	264.0	228.0	199.5	207.9	182.5	175.0	179.1	193.5	192.7	193.6	190.8	206.4	321.4	10.58 "	141.1	5.42 "
28	206.4	211.5	221.7	225.4	214.9	232.2	222.0	221.8	220.9	239.5	250.0	246.6	258.6	250.3	222.7	211.6	210.3	201.1	197.2	185.1	182.5	194.1	214.5	216.3	209.2	278.4	11.13 "	167.5	8.32 "
29	209.2	216.4	212.7	222.0	244.5	261.9	254.1	251.2	243.4	231.9	225.6	213.7	210.6	226.6	218.8	211.3	209.7	211.9	208.5	208.9	196.6	201.9	207.9	206.4	210.1	271.0	9.47 "	175.0	7.46 "
30	210.1	213.6	223.5	219.9	216.6	220.0	222.4	230.4	244.2	258.0	259.5	242.2	241.0	222.0	209.1	199.6	228.3	203.8	189.4	182.1	175.9	179.4	185.2	171.9	205.0	278.5	9.17 "	151.0	10.26 "
31	205.0	213.4	212.4	266.4	245.7	228.9	225.3	250.5	265.8	275.5	247.3	223.0	234.3	221.4	219.4	211.2	205.6	202.3	206.7	206.5	202.9	208.0	208.6	212.1	212.8	293.5	8.42 "	193.0	5.18 "

HOURLY VALUES.

DECLINATION, SEPTEMBER, 1903.

Day.	D = 150° +																								Maximum reading and time.	Minimum reading and time.			
	Midt.	Forenoon.										Noon.	Afternoon.										Midt.						
		0.	1.	2.	3.	4.	5.	6.	7.	8.	9.		10.	11.	12.	1.	2.	3.	4.	5.	6.	7.		8.				9.	10.
1	158.8	160.9	161.5	163.6	166.3	162.9	171.6	173.4	177.0	186.6	182.2	175.0	174.1	157.5	160.8	158.4	150.1	147.4	148.6	144.0	139.9	142.3	148.5	151.0	156.1	195.0	9.28 a.m.	122.5	8.14 p.m.
2	156.1	157.9	166.5	183.7	191.5	164.8	174.6	177.6	183.0	180.6	176.2	188.4	181.3	154.0	152.1	151.5	150.1	149.8	152.8	153.9	153.3	144.9	139.0	145.5	159.9	209.5	3.47 ,,	122.5	10.25 ,,
3	159.9	163.5	161.2	172.9	205.9	197.5	183.7	196.5	169.8	177.3	186.1	192.6	182.7	174.7	159.7	146.4	154.8	152.2	142.5	139.5	147.4	152.4	152.4	158.2	160.0	214.9	5.13 ,,	122.5	6.18 ,,
4	160.0	169.5	166.8	162.1	165.1	170.8	170.4	170.7	163.6	168.0	173.4	166.5	162.6	159.6	159.9	152.7	151.0	147.7	144.1	133.5	119.7	129.0	144.9	169.5	154.3	196.3	10.34 p.m.	102.7	8.50 ,,
5	154.3	157.2	157.0	156.0	170.5	191.4	193.8	172.5	171.6	193.5	209.5	197.7	144.7	144.6	136.0	137.5	123.4	132.7	132.9	154.5	138.6	156.1	150.6	145.3	163.8	233.8	6.14 a.m.	106.8	3.53 ,,
6	163.8	173.2	176.4	237.0	203.2	180.6	175.0	174.6	163.5	186.6	202.5	208.0	181.2	162.3	147.0	128.8	132.4	129.1	75.4	117.6	161.2	156.6	160.3	157.3	162.4	272.1	2.56 ,,	33.3	6.24 ,,
7	162.4	161.5	165.1	167.8	166.5	167.7	171.6	170.5	169.8	176.5	176.7	171.3	162.6	159.7	150.3	141.0	153.0	155.5	147.1	143.7	154.9	161.8	158.8	163.2	161.4	187.3	9.26 ,,	115.0	3.26 ,,
8	161.4	159.3	160.2	160.2	179.8	191.4	191.4	218.5	242.1	272.5+	250.0	224.1	184.0	173.5	150.6	134.4	134.4	121.9	140.4	138.3	132.0	134.7	144.7	164.2	165.4	272.5+	9.0 ,,	100.6	4.45 ,,
9	165.4	155.7	171.0	166.0	178.2	198.6	195.0	180.6	181.3	204.6	183.7	174.0	198.3	223.8	174.7	130.6	136.0	88.6	70.5	137.7	158.1	156.1	145.5	160.6	157.9	269.5+	0.55 p.m.	36.3	5.36 ,,
10	157.9	160.3	180.6	172.6	170.1	181.8	185.2	190.0	169.5	185.2	192.6	202.5	231.7	173.7	145.0	138.9	a	a	a	a	a	a	a	a	a	263.5	11.54 a.m.	100.3	2.30 ,,
11	a	a	a	a	a	a	a	a	a	a	a	a	a	a	a	a	a	a	a	a	a	a	a	a	a				
12	a	a	a	a	a	a	a	a	a	a	a	a	a	a	a	a	a	a	a	a	a	a	a	a	a				
13	a	a	a	a	a	a	a	a	a	a	a	a	a	a	a	a	a	a	a	a	a	a	a	a	a				
14	a	a	a	a	a	a	a	a	a	a	a	a	a	a	a	a	a	a	a	a	a	a	a	a	a				
15	a	a	a	a	a	a	a	a	a	a	a	a	a	a	a	a	a	a	a	a	a	a	a	a	a				
16	a	a	a	a	a	a	a	a	a	a	a	a	a	a	a	a	a	a	a	a	a	a	a	a	a				
17	a	a	a	a	a	a	a	a	a	a	a	a	a	a	a	a	a	a	a	a	a	a	a	a	a				
18	a	a	a	a	a	a	a	a	a	a	a	a	a	a	a	a	a	a	a	a	a	a	a	a	a				
19	a	a	a	a	a	a	a	a	a	a	a	a	a	a	a	a	a	a	a	a	a	a	a	a	a				
20	a	a	a	a	a	a	a	a	a	a	a	a	a	a	a	a	155.1	161.1	122.1	109.3	112.5	150.9	126.6	105.7	168.1	187.0	11.41 p.m.	74.5	11.1 p.m.
21	168.1	167.5	185.7	183.4	232.8	192.4	220.5	217.2	236.5	238.6	208.2	214.5	182.2	173.4	172.6	169.0	143.8	147.0	164.5	155.1	164.1	168.0	157.8	163.6	167.8	265.0+	7.55 a.m.	132.3	0.18 a.m.
22	167.8	174.4	186.6	217.0	212.5	217.2	204.7	196.0	194.7	202.0	204.6	203.5	199.6	190.6	192.0	185.2	174.3	169.2	159.3	144.1	148.8	151.3	153.1	158.1	151.8	254.5	6.49 ,,	133.8	10.29 p.m.
23	151.8	158.5	184.6	183.7	193.3	210.1	209.7	203.4	211.9	224.4	234.9	247.5	253.5	239.8	199.8	159.3	113.2	142.5	118.3	85.0	76.6	106.2	124.5	194.8	154.5	265.0+	11.55 ,,	56.5	7.23 ,,
24	154.5	194.2	220.8	183.3	186.6	185.5	203.8	223.5	208.5	240.6	195.0	212.1	262.0+	249.5	204.0	150.6	151.0	b	109.0	118.5	113.5	132.1	122.4	142.3	181.3	262.0+	Noon	46.0	5.30 ,,
25	181.3	186.1	193.2	180.1	190.9	185.4	181.0	168.0	192.0	198.7	223.6	173.8	195.6	180.7	179.7	174.4	168.6	166.6	a	a	a	a	a	a	249.3	9.34 a.m.	151.8	4.57 ,,	
26	a	a	a	a	a	a	a	a	a	a	a	a	a	a	a	a	a	a	a	a	a	a	a	a	a				
27	a	a	a	a	a	a	a	a	a	a	a	a	a	a	a	a	a	a	a	a	a	a	a	a	a				
28	a	a	a	a	a	a	a	a	a	a	a	a	a	a	a	a	a	a	a	a	a	a	a	a	a				
29	a	a	a	a	a	a	a	a	a	a	a	a	a	a	162.9	157.5	100.5	87.0	130.2	112.3	97.5	126.6	109.0	127.9	154.0	190.8	2.36 p.m.	4.8	5.24 p.m.
30	154.0	173.7	215.5	206.1	204.0	212.5	245.2	239.7	217.2	220.0	244.0	207.0	189.6	162.0	155.4	146.5	136.0	121.0	139.0	137.1	148.5	155.8	177.6	174.6	180.0	262.0+	9.40 a.m.	60.3	5.23 ,,

DECLINATION, OCTOBER, 1903.

D = 149° +

Day.	Midt.	Forenoon.											Noon.	Afternoon.											Midt.	Maximum reading and time.		Minimum reading and time.		
		0.	1.	2.	3.	4.	5.	6.	7.	8.	9.	10.		11.	12.	1.	2.	3.	4.	5.	6.	7.	8.	9.		10.	11.	12.		
1	245°0	240°9	242°9	254°6	272°3	283°5	291°6	299°3	328°5+	273°0	279°8	281°4	282°2	286°4	278°3	255°2	239°9	217°7	197°6	205°1	215°9	219°3	232°2	218°7	245°1	328°5+	8.0 a.m.	185°3	6.43 p.m.	
2	245°1	224°7	270°9	245°0	253°2	270°5	254°6	246°5	286°1	330°0+	302°0	288°5	230°0	219°8	217°8	213°3	218°9	208°5	193°5	147°5	172°4	150°8	242°6	247°8	227°6	330°0+	9.0 "	120°6	7.30 "	
3	227°6	264°0	275°0	273°9	266°0	262°5	262°5	258°5	250°5	283°5	264°5	260°0	244°1	250°2	236°6	205°5	a	a	a	a	a	a	a	a	a	326°6	9.16 "	201°8	2.39 "	
4	a	a	a	a	a	a	a	a	a	a	a	a	a	a	a	a	a	a	a	a	a	a	a	a	a	a	a	a	a	a
5	a	a	a	a	a	a	a	a	a	a	a	a	a	a	a	a	a	a	a	a	a	a	a	a	a	a	a	a	a	a
6	a	a	a	a	a	a	a	a	a	a	a	a	a	a	a	a	a	186°2	188°6	178°2	174°5	231°5	241°8	239°7	226°5	261°3	9.52 p.m.	136°5	7.51 p.m.	
7	226°5	261°5	262°1	282°0	285°0	274°1	317°0	326°6	240°5	295°5	288°5	241°5	277°5	267°5	256°4	199°1	211°5	170°6	204°5	147°5	204°0	241°5	228°0	250°5	242°7	327°0+	7.5 a.m.	129°0	7.19 "	
8	242°7	230°0	257°6	254°1	245°6	286°2	308°0	307°0	283°5	270°5	291°5	270°3	233°0	219°8	217°7	264°0	213°3	a	a	a	a	a	a	a	a	327°0+	6.30 "	157°8	2.42 "	
9	a	a	a	a	a	a	a	a	a	a	a	a	a	a	a	a	a	a	a	a	a	a	a	a	a	a	a	a	a	a
10	a	a	a	a	a	a	a	a	a	a	a	a	a	a	a	a	a	a	a	a	a	a	a	a	a	a	a	a	a	a
11	a	a	a	a	a	a	a	a	a	a	a	a	a	a	a	a	a	a	a	a	a	a	a	a	a	a	a	a	a	a
12	a	a	a	a	a	a	a	a	a	a	a	a	a	a	a	a	a	a	a	a	a	a	a	a	a	a	a	a	a	a
13	258°2	278°6	317°0	331°5+	331°5+	331°5+	331°5+	331°5+	331°5+	331°5+	331°5+	331°5+	331°5	249°2	297°0	216°2	39°0-	125°1	a	a	a	a	a	a	a	331°5+	11.58 p.m.	56°1	9.51 p.m.	
14	a	a	a	a	a	a	a	a	a	a	a	a	a	a	a	a	a	a	a	a	a	a	a	a	a	a	a	a	a	a
15	a	a	a	a	a	a	a	a	a	a	a	a	a	a	a	a	a	224°3	215°3	210°0	222°5	229°4	230°6	243°0	228°0	249°6	10.39 p.m.	194°7	6.28 p.m.	
16	228°0	250°2	254°0	268°4	254°0	239°1	279°5	286°1	293°5	331°5+	331°5+	314°5	264°0	257°3	264°5	261°6	232°2	227°6	230°3	231°2	233°0	223°8	221°7	245°0	246°2	331°5+	9-11 a.m.	210°8	9.5 "	
17	246°2	243°8	244°5	267°5	276°0	298°1	308°3	273°0	330°0+	297°8	287°6	287°0	308°9	274°1	263°0	255°8	236°6	b	221°6	222°0	227°3	217°7	213°3	250°8	240°8	330°0+	8.0 "	184°5	9.50 "	
18	240°8	223°1	259°5	260°6	255°3	297°6	290°0	281°6	327°0+	327°0+	262°7	277°1	271°2	257°4	258°9	247°8	223°5	a	a	a	a	a	a	a	a	327°0+	8.0 "	184°4	3.29 "	
19	a	a	a	a	a	a	a	a	a	a	a	a	a	a	a	a	a	a	a	a	a	a	a	a	a	a	a	a	a	a
20	a	a	a	a	a	a	a	a	a	a	a	a	a	a	a	a	a	a	a	a	a	a	a	a	a	a	a	a	a	a
21	a	a	a	a	a	a	a	a	a	a	a	a	a	a	a	a	a	a	a	a	a	a	a	a	a	a	a	a	a	a
22	a	a	a	a	a	a	a	a	a	a	a	a	a	a	a	a	a	a	a	a	a	a	a	a	a	a	a	a	a	a
23	a	a	a	a	a	a	a	a	a	a	a	a	a	a	a	a	a	a	a	a	a	a	a	a	a	a	a	a	a	a
24	a	a	a	a	a	a	a	a	a	a	a	a	a	a	a	a	a	a	a	a	a	a	a	a	a	a	a	a	a	a
25	a	a	a	a	a	a	a	a	a	a	a	a	a	a	a	a	a	a	a	a	a	a	a	a	a	a	a	a	a	a
26	a	a	a	a	a	a	a	a	a	a	a	a	a	a	a	a	a	a	a	a	a	a	a	a	a	a	a	a	a	a
27	229°7	229°2	248°0	252°6	276°9	297°0	307°2	328°5+	328°5+	328°5+	328°5+	328°5+	328°5+	314°0	294°0	252°6	223°1	222°5	205°7	164°7	182°6	191°0	191°0	247°4	244°8	328°5+	11.43 p.m. to 7.5 a.m.	136°8	8.5 p.m.	
28	244°8	243°5	251°6	257°3	266°0	264°9	289°1	316°5	313°1	301°1	316°1	283°1	286°1	281°6	268°1	229°1	212°6	a	a	a	a	a	a	a	a	330°0+	129°8	7.22 "		
29	a	a	a	a	a	a	a	a	a	a	a	a	a	a	a	a	a	a	a	a	a	a	a	a	a	a	a	a	a	a
30	a	a	a	a	a	a	a	a	a	a	a	a	a	a	a	a	a	a	a	a	a	a	a	a	a	a	a	a	a	a
31	a	a	a	a	a	a	a	a	a	a	a	a	a	a	a	a	a	a	a	a	a	a	a	a	a	a	a	a	a	a

E-2

HOURLY VALUES.

DECLINATION, NOVEMBER AND DECEMBER, 1903, AND JANUARY, 1904.

NOVEMBER, 1903.

D = 150° +

Day.	Midt.	Forenoon.										Noon.	Afternoon.										Midt.	Maximum reading and time.	Minimum reading and time.													
		0.	1.	2.	3.	4.	5.	6.	7.	8.	9.		10.	11.	12.	1.	2.	3.	4.	5.	6.	7.					8.	9.	10.	11.	12.							
1	/	/	/	/	/	/	/	/	/	/	/	/	/	/	/	/	/	/	/	/	/	/	/	/	/	/	/	/	/	/	/	/	/	/	/	/	/	/
2	151.5	171.0	219.3	207.5	221.6	216.0	191.0	221.6	190.1	264.0	253.5	265.5+	210.8	220.5	172.5	142.4	105.5	88.4	73.5	120.5	140.4	176.7	135.5	152.6	157.1	265.5+	11.0	a.m.	44.1	5.56	..							
3	157.1	180.5	229.5	221.0	255.0	270.0+	267.5	237.0	270.0+	270.0+	270.0+	270.0+	a	a	a	a	a	a	a	a	a	a	a	a	a	270.0+	9-10	..	127.5	0.10	a.m.							
4	a	a	a	a	a	a	a	a	a	a	a	a	a	a	a	a	a	a	a	a	a	a	a	a	a	a	a	a	a	a	a	a	a	a				
5	a	a	a	a	a	a	a	a	a	a	a	a	209.5	148.1	164.6	131.0	154.1	134.0	142.7	141.6	137.0	124.5	173.6	200.4	202.1	268.5+	11.40	a.m.	76.5	3.2	p.m.							
6	202.1	199.7	178.1	217.4	247.1	262.0	233.9	226.5	247.1	265.5	b	249.0	218.0	184.1	173.1	144.2	143.6	151.5	128.7	132.8	146.0	128.3	133.5	148.4	171.5	270.0+	8.55	..	64.5	1.43	a.m.							
7	171.5	175.1	201.5	201.5	217.1	209.6	199.5	173.7	187.1	212.3	205.5	a	a	a	a	a	a	a	a	a	a	a	a	a	a	282.0+	9.35	..	149.3	6.54	..							
8	a	a	a	a	a	a	a	a	a	a	a	a	a	a	a	a	a	a	a	a	a	a	a	a	a	a	a	a	a	a	a	a	a					
9	176.6	182.0	184.5	188.5	221.0	258.0	250.5	280.5+	280.5+	280.5+	280.5+	280.5+	a	a	a	a	a	a	a	a	a	a	a	a	a	a	280.5+	10.0	..	153.8	2.36	a.m.						

DECEMBER, 1903.

D = 149° +

Day.	Midt.	Forenoon.										Noon.	Afternoon.										Midt.	Maximum reading and time.	Minimum reading and time.										
		0.	1.	2.	3.	4.	5.	6.	7.	8.	9.		10.	11.	12.	1.	2.	3.	4.	5.	6.	7.					8.	9.	10.	11.	12.				
12	/	/	/	/	/	/	/	/	/	/	/	/	/	/	/	/	/	/	/	/	/	/	/	/	/	/	/	/	/	/	/	/	/	/	/
13	209.3	206.0	199.7	216.6	244.7	259.1	277.1	256.5	274.1	290.6	287.6	286.7	b	273.8	246.3	210.5	200.6	175.2	176.6	183.3	187.7	179.0	169.5	164.3	106.5	307.5	9.6	a.m.	88.5	11.55	p.m.				
14	106.5	135.0	150.0	212.0	264.0	336.0+	313.5	336.0+	336.0+	336.0+	336.0+	71.0	85.1	96.0	206.1	294.0	197.0	96.5	131.9	135.9	141.9	147.0	136.8	145.4	133.1	336.0+	6-9	..	42.0-	10.45	a.m.				
15	133.1	110.0	190.2	203.0	177.5	174.5	214.1	242.9	328.5	211.5	260.0	198.5	182.6	199.5	197.6	177.2	177.3	211.2	201.6	184.2	182.9	190.5	208.4	196.8	164.0	336.0+	7.45	..	43.5	1.19	..				
16	164.0	174.0	192.5	185.0	217.1	245.6	245.3	175.5	43.5-	152.6	106.1	121.5	106.5	a	a	a	a	a	a	a	a	a	a	a	a	a	327.0	5.13	..	43.5-	8.0	..			

JANUARY, 1904.

D = 150° +

Day.	Midt.	Forenoon.										Noon.	Afternoon.										Midt.	Maximum reading and time.	Minimum reading and time.											
		0.	1.	2.	3.	4.	5.	6.	7.	8.	9.		10.	11.	12.	1.	2.	3.	4.	5.	6.	7.					8.	9.	10.	11.	12.					
7	/	/	/	/	/	/	/	/	/	/	/	/	/	/	/	/	/	/	/	/	/	/	/	/	/	/	/	/	/	/	/	/	/	/	/	
8	199.6	218.0	213.8	167.0	183.1	173.3	172.6	234.0	238.6	237.1	232.0	249.5+	249.5+	249.5+	a	a	a	a	a	a	a	a	a	a	a	a	a	a	a	a	a	a	a	a		
9	175.0	179.0	195.1	210.8	189.5	227.5	233.0	248.0+	a	a	a	a	a	a	a	a	a	a	a	a	a	a	a	a	a	a	a	a	a	a	a	a	a	a		
10	a	a	a	a	a	a	a	a	a	a	a	a	a	a	a	a	a	a	a	a	a	a	a	a	a	a	a	a	a	a	a	a	a	a	a	
11	a	a	a	a	a	a	a	a	a	a	a	a	a	a	a	a	a	a	a	a	a	a	a	a	a	a	a	a	a	a	a	a	a	a	a	
12	a	a	a	a	a	a	a	a	a	a	a	a	153.0	c	131.0	92.5	71.8	103.0	79.0	69.5	a	a	a	a	a	a	a	a	a	a	a	a	a	a	a	
13	a	a	a	a	a	a	a	a	a	a	a	a	a	a	a	a	a	a	a	a	a	a	a	a	a	a	a	a	a	a	a	a	a	a	a	
14	a	a	a	a	a	a	a	a	a	a	a	a	a	a	a	a	a	a	a	a	a	a	a	a	a	a	a	a	a	a	a	a	a	a	a	a
15	a	a	a	a	a	a	a	a	a	a	a	a	183.5	164.8	162.2	144.1	133.0	140.0	a	a	a	a	a	a	a	a	a	a	a	a	a	a	a	a	a	a
16	a	a	a	a	a	a	a	a	a	a	a	a	249.5+	249.5+	249.5+	211.0	153.5	113.5	92.0	63.1	63.5	54.5	68.0	80.5	73.0	249.5+	1.0	..	19.3	11.52	..					
17	73.0	126.5	148.0	206.0	208.0	222.5	249.5+	249.5+	249.5+	249.5+	249.5+	249.5+	249.5+	249.5+	249.5+	234.5	203.3	193.4	193.7	179.0	174.8	a	a	a	a	a	a	a	a	a	a	a	a	a		

### HORIZONTAL FORCE, MARCH, 1902.

Day.	H = '06... C.G.S.																								Maximum reading and time.		Minimum reading and time.				
	Midt.	Forenoon.										Noon.	Afternoon.										Midt.								
		0.	1.	2.	3.	4.	5.	6.	7.	8.	9.		10.	11.	12.	1.	2.	3.	4.	5.	6.	7.		8.					9.	10.	11.
1	a	a	a	a	a	a	a	a	a	a	a	a	a	a	a	a	a	a	a	a	a	a	a	a	a						
2	a	671	a	a	674	664	662	695	696	709	d	d	d	d	d	d	d	d	d	d	d	d	d	d	a	a	724	9.30 a.m.	643	3.38 a.m.	
3	d	d	d	d	d	d	d	d	d	d	d	d	d	d	d	d	d	d	d	d	d	d	d	d	d						
4	d	d	d	d	d	d	d	d	d	d	d	d	d	d	d	d	d	d	d	d	d	d	d	d	d						
5	d	d	d	d	d	d	d	d	d	d	d	d	d	d	d	d	d	d	d	d	d	d	d	d	d						
6	d	d	d	d	d	d	d	d	d	d	d	d	d	d	d	d	d	d	d	d	d	d	d	d	d						
7	a	a	a	a	a	a	a	a	a	a	a	a	a	a	a	a	a	a	a	a	a	a	a	a	a						
8	a	a	a	a	a	a	a	a	a	a	a	a	a	a	a	a	a	a	a	a	a	a	a	a	a						
9	a	a	a	a	a	a	a	a	a	a	a	a	a	a	a	a	a	a	a	a	a	a	a	a	a						
10	a	a	a	a	a	a	a	a	a	a	a	a	a	a	a	a	a	a	a	a	a	a	a	a	a						
11	a	a	a	a	a	a	a	a	a	a	a	a	a	a	a	a	a	a	a	a	a	a	a	a	a						
12	a	a	a	a	a	a	a	a	a	a	a	a	a	a	a	a	a	a	a	a	a	a	a	a	a						
13	a	a	a	a	a	a	a	a	a	a	a	a	639	621	626	649	a	a	a	a	a	a	a	a	a	a					
14	a	a	a	a	a	a	a	a	a	a	a	a	a	a	a	a	a	a	a	a	a	a	a	a	a	690	11.57 a.m.	595	3.32 p.m.		
15	a	a	a	a	a	a	a	a	a	580	598	604	608	a	a	a	a	a	a	a	a	a	a	a	a						
16	602	608	597	589	620	636	648	660	649	626	617	639	682+	682+	682+	682+	682+	682+	682+	682+	662	639	630	622	616	682+	11.34 a.m.	562	9.10 a.m.		
17	616	608	594	548	488-	530	552	a	a	a	a	a	600	656	656	684+	663	630	587	543	521	488-	488-	488-	488-	684+	1-7 p.m.	564	2.1 ..		
18	489-	489-	520	489-	489-	489-	489-	489-	548	553	543	556	b	592	617	682+	577	566	533	506	504	489-	497	504	500	682+	2.30 ..	488-	10-12 p.m.		
19	500	503	503	507	514	512	531	538	542	548	541	560	582	b	b	716+	716+	642	625	601	580	581	586	593	587	716+	3-4 ..	493	0-6 a.m.		
20	587	588	584	586	597	576	581	588	584	627	645	671	716+	683	716+	c	c	c	c	c	c	c	c	c	c	608	608	716+	Noon	531	5.6 ..
21	608	604	604	608	614	628	c	644	664	701	671	685	685	689	664	668	666	650	c	c	c	c	c	c	c	714	9.5 a.m.	541	8.30 p.m.		
22	a	a	a	a	a	a	a	a	a	a	a	a	a	a	a	a	a	a	677	688	713+	638	620	604	578	713+	8.0 p.m.	556	11.54 ..		
23	578	586	580	587	577	588	593	c	595	591	592	616	602	c	c	c	c	c	c	c	c	c	c	c	c	632	11.42 a.m.	542	1.45 a.m.		
24	c	c	c	c	c	c	c	c	c	c	c	c	c	c	c	c	c	c	c	c	c	c	c	c	c						
25	c	c	c	c	c	c	c	c	c	c	c	c	c	c	c	c	c	c	c	c	c	c	c	c	c						
26	c	c	c	c	c	c	c	c	c	c	c	c	c	c	c	c	c	c	c	c	c	c	c	c	c						
27	c	c	c	c	c	c	c	c	c	c	c	c	c	c	c	c	c	c	c	c	c	c	c	c	c						
28	c	c	c	c	c	c	c	c	c	c	c	c	c	c	c	c	c	c	c	c	c	c	c	c	c						
29	551	582	582	581	585	570	605	619	617	633	621	608	639	618	595	586	547	546	549	546	519	516	513	522	525	672	3.28 p.m.	528	11.35 p.m.		
30	525	527	525	496-	496-	496-	496-	553	570	557	565	595	564	601	575	584	586	584	552	527	526	525	520	525	528	689	0.5 ..	507	9.49 ..		
31	528	526	527	527	521	503-	503-	503-	503-	517	527	559	a	a	a	a	a	a	a	a	a	a	a	a	a	595	10.47 a.m.	496-	3-6 a.m.		

HOURLY VALUES.



HORIZONTAL FORCE, APRIL, 1902.

H = .06 . . . C.G.S.

Day.	Forenoon.												Afternoon.												Midt.	Maximum reading and time.	Minimum reading and time.			
	0.	1.	2.	3.	4.	5.	6.	7.	8.	9.	10.	11.	12.	1.	2.	3.	4.	5.	6.	7.	8.	9.	10.	11.				12.		
1	a	a	a	a	a	a	a	a	a	a	a	a	a	660	678	647	641	645	580	589	529	614	496-	496-	707	2.12 p.m.	496-	11.50 p.m.		
2	496-	611	614	603	607	587	616	591	667	694	712+	712+	707	700	699	701	b	664	656	648	617	624	622	623	620	712+	{ 10.20 a.m. 11.20 "	496-	0.0 a.m.	
3	620	594	594	587	594	625	595	626	647	681	712+	704	712+	712+	712+	712+	679	638	600	560	560	526	496-	496-	712+	0-4 p.m.	496-	11-12 p.m.		
4	496-	496-	496-	547	529	496-	496-	496-	540	619	634	669	b	565	529	554	515	536	517	511	507	496-	496-	496-	496-	697	11.17 a.m.	496-	{ 1-2 a.m. 6-7 " 9-12 p.m.	
5	496-	496-	496-	496-	496-	496-	496-	496-	496-	524	496-	538	b	586	572	561	542	496-	525	496-	514	517	496-	496-	496-	618	0.37 p.m.	496-	{ 0-8 a.m. 9-12 p.m.	
6	503-	503-	503-	503-	503-	503-	503-	503-	503-	503-	565	555	b	657	626	607	609	607	588	617	585	566	568	503-	503-	676	0.32 "	503-	0-9 "	
7	510-	539	551	510-	510-	510-	529	574	589	611	648	633	661	671	690	681	647	666	621	609	592	604	590	593	591	712+	2.58 "	510-	3-5 "	
8	591	591	581	563	567	538	568	582	620	642	661	699+	699+	b	b	633	632	606	603	594	598	559	563	503-	503-	699+	11-12 a.m. 11.20 a.m.	503-	12 p.m.	
9	503-	532	554	561	589	572	588	602	601	597	648	620	710+	b	672	674	688	682	649	611	549	578	564	525	565	710+	{ 11-12 a.m. 11.20 a.m. and Noon 10.19 a.m.	503-	0.0 a.m.	
10	565	503-	503-	503-	574	589	592	565	559	611	650	649	642	b	675	657	637	626	628	619	613	590	583	601	593	701		503-	1-3 a.m.	
11	593	c	c	561	495	573	c	c	c	c	c	c	c	c	c	c	c	721	574-	574-	c	c	c	c	c					
12	c	c	c	c	c	c	c	c	c	c	c	c	c	c	c	567-	567-	720	706	690	667	646	657	660	660	720	3.10 p.m.	567-	{ 0 a.m. to 4 p.m.	
13	660	665	666	668	667	668	667	669	670	674	677	679	685	685	684	684	686	678	668	664	664	656	641	630	653	690	3.10 "	602	10.57 p.m.	
14	653	659	656	660	655	658	650	656	663	664	657	670	663	667	663	658	646	647	644	622	606	604	602	599	598	687	11.15 a.m.	590	10.11 "	
15	598	597	599	599	608	608	606	612	613	613	622	623	628	626	622	625	636	632	629	629	622	629	629	628	628	642	4.5 p.m.	591	0.25 a.m.	
16	628	627	628	627	628	628	633	632	633	634	636	642	641	644	b	657	654	656	653	652	a	a	a	a	a	673+	2.28 "	623	2.44 "	
17	a	a	a	a	a	a	a	a	a	a	a	a	a	a	616	613	610	591	571	561	556	553	548	547	548	630	2.16 "	542	11.31 p.m.	
18	548	547	550	549	550	552	548	543	549	546	552	558	564	570	570	571	575	573	565	553	538	534	535	532	549	579	4.8 "	524	11.14 "	
19	549	556	552	548	542	542	538	544	548	552	562	565	563	566	556	544	556	566	559	557	553	544	543	531	525	572	5.12 "	515	11.55 "	
20	525	534	520	532	517	519	519	529	533	534	533	531	531	554	568	550	537	541	544	546	540	531	521	484	468	573	1.40 "	459	11.47 "	
21	468	475	463	489	462	503	505	506	503	513	520	531	530	543	538	532	538	552	532	508	502	500	499	495	491	560	5.5 "	440-	{ 1.50 a.m. and 3.50 a.m.	
22	491	485	480	486	481	475	490	492	493	502	517	527	523	523	513	497	487	485	459	456	459	464	449	464	454	548	0.48 "	437	10.13 p.m.	
23	454	460	468	467	471	446	461	462	466	476	485	487	494	494	488	488	482	484	474	468	469	465	445	455	459	511	10.30 a.m.	417	9.34 "	
24	459	460	449	451	468	459	464	464	465	466	473	475	480	495	501	519	503	501	490	481	479	478	474	473	476	538	3.6 p.m.	436	2.7 a.m.	
25	476	477	477	476	476	477	477	477	480	480	481	479	489	487	496	492	488	482	479	477	473	470	466	470	475	503	2.31 "	462	9.52 p.m.	
26	475	475	474	473	471	470	471	472	473	476	480	487	494	498	497	495	494	492	490	486	480	477	474	479	479	501	1.16 "	465	4.35 a.m.	
27	479	479	479	479	477	481	480	474	480	484	488	492	491	489	480	463	447	442	445	449	450	448	451	454	456	494	11.40 a.m.	442	5.15 p.m.	
28	456	458	465	465	455	447	496	429	439	449	460	469	474	477	476	473	468	464	458	455	456	457	458	459	459	481	0.31 p.m.	427	6.42 a.m.	
29	459	461	460	451	a	a	a	a	a	a	a	a	439	437	441	436	428	427	427	426	430	434	430	426	463	1.28 a.m.	425	5.28 p.m.		
30	426	427	424	424	423	421	a	a	a	a	a	a	a	a	a	a	a	a	448	440	431	414	410	404	399	451	5.50 p.m.	394	11.25 "	

HORIZONTAL FORCE, MAY, 1902.

Day.	H = '06 . . . C.G.S.																										Maximum reading and time.		Minimum reading and time.	
	Midt.	Forenoon.											Noon.	Afternoon.											Midt.					
		0.	1.	2.	3.	4.	5.	6.	7.	8.	9.	10.		11.	12.	1.	2.	3.	4.	5.	6.	7.	8.	9.		10.				
1	399	400	396	387	386	393	398	401	405	408	408	407	a	a	a	a	a	a	a	506	504	502	503	499	512	7.50 p.m.	375	2.52 a.m.		
2	499	499	490	493	488	485	489	499	506	512	514	509	509	518	522	550	529	516	506	494	494	496	498	500	505	558	3.15 "	480	5.19 "	
3	505	502	501	502	495	489	497	494	491	494	490	495	499	507	527	532	535	535	522	514	510	508	502	501	501	541	4.8 "	486	9.16 "	
4	501	496	496	495	496	496	500	502	505	509	517	518	515	522	526	525	527	533	527	532	519	513	510	507	502	539	4.55 "	492	4.51 "	
5	502	507	504	497	488	492	499	510	516	522	527	528	526	526	521	518	515	513	511	510	507	504	503	501	501	529	10.18 a.m.	480	4.3 a.m.	
6	501	497	490	482	492	497	500	500	499	502	505	513	515	510	504	502	502	502	496	490	486	485	483	480	480	520	10.36 "	476	10.50 p.m.	
7	480	484	484	485	485	487	487	493	492	496	499	501	498	499	491	486	480	476	472	473	481	477	471	470	451	510	0.42 p.m.	478	0.1 a.m.	
8	451	468	472	467	465	447	463	472	472	477	482	484	489	488	491	493	491	488	488	486	485	486	486	487	487	494	2.56 "	441	4.58 "	
9	487	488	480	474	449	423	450	488	483	482	481	485	494	517	537	553	539	564	559	542	505	475	479	415	424	571	4.55 "	395	4.37 "	
10	424	392	406	382	386	391	417	427	431	442	c	c	c	c	c	534	496	447	381	361	356	340-	340-	340-	340-	564	2.22 "	340-	9-12 p.m.	
11	340-	340-	340-	340-	340-	340-	340-	340-	340-	340-	340-	355	355	a	a	a	a	a	a	a	a	a	a	a	a	369	4.8 a.m.	340-	0-9 a.m.	
12	a	a	a	a	a	a	a	a	a	a	a	a	a	525	524	524	519	510	507	498	498	493	493	483	478	535	0.46 p.m.	463	11.22 p.m.	
13	478	487	486	490	491	491	c	497	500	501	503	502	502	503	504	502	512	517	518	503	a	a	a	a	a	531	6.13 "	470	0.10 a.m.	
14	a	a	a	a	a	a	a	a	a	a	a	a	a	a	a	a	a	a	a	a	a	a	a	a	a	a	a	a	a	a
15	a	a	a	a	a	a	a	a	a	a	a	a	a	a	a	a	a	a	a	a	a	a	a	a	a	508	11.44 p.m.	497	9.54 p.m.	
16	506	504	502	502	504	504	513	517	516	516	517	517	516	519	520	520	522	519	516	517	515	516	515	509	509	526	4.11 "	496	5.1 a.m.	
17	509	514	521	526	530	530	533	533	534	535	539	541	541	544	546	537	538	529	527	521	517	514	510	509	510	555	2.5 "	508	11.12 p.m.	
18	510	510	512	507	508	502	503	503	507	514	513	522	517	531	543	533	525	520	520	517	516	510	499	490	492	552	2.21 "	481	10.59 "	
19	492	502	502	508	500	504	505	506	509	508	510	512	519	520	516	518	515	514	517	506	503	494	495	501	500	534	0.36 "	483	10.26 "	
20	500	500	505	498	498	496	493	493	501	508	520	533	525	542	509	507	520	515	508	508	506	502	498	499	499	563	1.3 "	479	5.46 a.m.	
21	499	489	501	503	504	499	501	502	502	502	508	503	504	507	507	507	517	505	506	498	498	497	487	494	495	531	3.59 "	477	10.5 p.m.	
22	495	494	484	495	494	496	493	497	499	500	502	506	509	513	513	511	516	511	511	506	500	498	503	497	502	524	4.18 "	477	4.36 a.m.	
23	502	500	503	503	503	505	508	510	513	513	515	511	519	518	515	515	512	511	511	504	a	a	a	a	a	521	0.34 "	500	3.46 "	
24	a	a	a	a	a	a	a	a	a	a	a	a	a	a	a	a	a	a	a	a	a	a	a	a	a	521	0.34 "	500	3.46 "	
25	514	517	517	516	515	515	508	503	509	513	517	521	536	536	544	538	523	518	514	504	497	492	491	492	493	556	2.10 "	484	9.14 "	
26	493	490	494	493	494	495	495	496	497	499	499	503	502	527	515	516	509	500	515	489	483	480	478	474	468	536	0.44 "	470	11.59 "	
27	468	467	462	455	459	460	458	459	462	462	465	463	469	505	526	521	521	524	510	507	504	502	503	502	500	530	2.0 "	448	2.58 a.m.	
28	500	501	501	502	493	500	505	502	507	505	512	501	521	529	533	523	523	527	521	516	513	509	510	508	507	537	1.42 "	489	3.43 "	
29	507	508	509	511	509	509	510	512	519	524	530	529	5 2	526	526	530	532	534	536	530	526	514	509	508	506	541	9.53 a.m.	502	9.32 p.m.	
30	506	482	490	499	511	512	518	516	531	532	523	526	543	563	563	581	577	591+	571	540	518	514	523	524	516	591+	5.0 p.m.	472	1.12 a.m.	
31	516	507	505	508	509	505	513	514	515	514	518	515	520	529	535	530	530	513	506	491	492	489	487	486	479	540	2.35 "	478	11.59 p.m.	

HOURLY VALUES.

## HORIZONTAL FORCE, JUNE, 1902.

H = .06 . . . C.G.S.

Day.	H = .06 . . . C.G.S.																								Maximum reading and time.		Minimum reading and time.			
	Midt.	Forenoon.											Noon.	Afternoon.															Midt.	
		0.	1.	2.	3.	4.	5.	6.	7.	8.	9.	10.		11.	12.	1.	2.	3.	4.	5.	6.	7.	8.	9.						10.
1	554	552	551	542	545	551	548	548	550	551	563	566	579	582	592	637	587	578	586	565	580	564	550	548	558	656	3.5 p.m.	534	3.52 a.m.	
2	558	564	552	556	560	561	563	559	570	574	575	577	578	584	585	583	577	579	564	560	560	562	566	572	578	588	2.19 "	544	1.42 "	
3	578	581	583	582	586	589	591	590	578	568	569	576	604	616	612	603	581	582	596	589	583	581	583	585	584	617	0.25 "	566	8.45 "	
4	584	585	585	583	578	575	574	575	575	576	576	575	579	584	587	590	587	585	585	588	586	583	582	574	568	593	3.18 "	566	11.50 p.m.	
5	568	563	562	567	573	571	582	585	588	594	596	597	613	617	611	599	592	587	580	571	575	566	563	565	568	626	1.40 "	558	1.48 a.m.	
6	568	576	582	584	582	585	584	580	578	577	578	583	594	594	591	590	590	591	588	598	583	580	582	581	584	605	6.56 "	565	0.8 "	
7	584	581	573	560	564	572	578	564	564	571	569	564	564	567	573	575	576	581	586	578	585	580	585	587	586	592	9.50 "	548	5.28 "	
8	586	591	594	588	587	592	592	590	594	590	587	588	589	591	580	584	592	601	605	604	591	585	581	578	580	610	5.36 "	571	1.43 p.m.	
9	580	586	583	580	584	582	583	581	581	579	576	573	575	581	578	581	587	583	584	580	579	580	580	579	578	594	4.20 "	570	Noon	
10	578	578	576	580	580	578	582	579	582	585	586	a	a	a	a	a	a	a	a	a	a	a	a	a	a	588	10.45 a.m.	571	4.58 a.m.	
11	a	a	a	a	a	a	a	a	a	a	a	a	a	a	a	a	a	597	603	603	585	581	581	585	567	614	6.37 p.m.	563	11.59 p.m.	
12	567	558	561	572	571	564	577	588	588	592	599	611	619	614	609	603	609	606	630	611	605	585	587	574	577	650	5.43 "	551	1.30 a.m.	
13	577	586	586	586	584	576	580	584	587	586	590	596	622	611	612	610	608	600	598	596	594	593	573	583	589	625+	0.30 "	546	9.54 p.m.	
14	589	590	594	593	591	590	590	588	587	589	589	590	589	597	601	611	618	627	625	620	621	611	611	607	599	595	634	4.19 "	571	11.46 "
15	577	588	588	586	589	579	592	591	589	590	591	594	597	601	611	618	627	625	620	621	611	611	607	599	595	634	4.0 "	574	0.1 a.m.	
16	595	596	610	613	618	617	618	621	619	620	618	625	620	631	622	638	632	627	614	602	590	604	599	609	611	650	4.4 "	554	0.41 "	
17	611	611	609	608	608	604	607	607	606	607	608	609	612	617	612	610	613	610	608	610	611	611	613	612	611	620	3.56 "	601	5.4 "	
18	611	609	614	611	605	605	606	604	603	600	602	604	604	605	610	613	617	615	609	607	602	599	598	601	602	623	3.30 "	588	8.42 p.m.	
19	602	601	602	598	595	593	589	590	590	593	597	598	b	605	603	606	599	596	599	600	600	601	606	596	603	614	3.19 "	586	6.14 a.m.	
20	603	604	606	601	596	591	598	597	597	598	604	610	604	613	613	612	611	616	604	598	596	599	601	599	595	628	4.54 "	588	5.6 "	
21	595	594	593	589	587	587	588	588	588	585	586	587	592	593	589	589	586	581	579	578	577	580	583	587	570	602	0.54 "	572	6.38 p.m.	
22	570	554	594	592	591	590	590	588	589	590	591	592	594	596	602	601	598	596	598	598	594	571	579	575	579	604	2.33 "	486	0.39 a.m.	
23	579	572	583	579	586	590	589	583	589	590	595	595	600	611	605	602	597	597	591	580	576	574	577	579	580	622	0.45 "	564	1.12 "	
24	580	580	579	579	581	581	581	582	583	584	584	584	584	585	585	580	582	579	580	581	584	581	570	571	581	589	1.40 "	563	10.18 p.m.	
25	581	576	586	578	578	577	581	578	584	588	598	600	610	637	608	602	585	588	584	572	569	570	570	570	568	651	0.58 "	565	7.26 "	
26	568	572	574	576	578	583	580	581	580	581	587	588	596	610	663+	632	600	603	610	606	576	582	580	579	567	663+	2.0 "	563	0.21 a.m.	
27	567	553	554	555	551	566	577	574	580	583	586	582	578	574	575	576	579	578	579	576	576	554	559	576	572	593	4.29 "	537	9.12 p.m.	
28	572	567	578	574	582	584	576	575	579	581	586	600	602	613	629	641	614	594	583	581	572	561	563	561	561	664	2.30 "	554	0.48 a.m.	
29	561	561	554	550	550	541	541	542	555	566	562	565	573	559	569	573	569	569	564	562	550	541	544	542	530	587	0.15 "	524	8.21 p.m.	
30	530	544	532	537	516	534	554	566	572	576	598	598	625	612	649	656	642	621	598	590	587	570	582	577	577	664+	2.49 "	504	3.36 a.m.	

# HORIZONTAL FORCE, JULY, 1902.

Day.	H = '06 . . . C.G.S.																								Maximum reading and time.	Minimum reading and time.			
	Midt.	Forenoon.											Noon.	Afternoon.													Midt.		
		0.	1.	2.	3.	4.	5.	6.	7.	8.	9.	10.		11.	12.	1.	2.	3.	4.	5.	6.	7.	8.	9.				10.	11.
1	627	628	610	605	607	618	607	629	628	631	635	637	646	644	657	684	648	638	634	648	626	625	617	616	616	698	2.38 p.m.	578	3.30 a.m.
2	616	604	608	612	618	618	613	621	624	624	624	635	639	649	638	627	619	614	613	615	613	610	608	615	617	654	1.11 "	597	1.3 "
3	617	618	619	618	619	616	618	618	620	620	622	624	624	623	622	622	625	628	620	619	621	621	620	616	616	632	4.46 "	609	5.25 "
4	616	612	612	612	611	608	605	611	610	616	616	616	618	621	623	636	658	684	650	632	625	614	601	590	587	702	4.30 "	568	11.35 p.m.
5	587	608	604	608	607	605	601	595	598	604	608	608	611	616	621	625	627	616	613	611	614	601	602	600	605	641	3.35 "	574	9.24 "
6	605	612	611	613	616	614	616	618	619	623	622	621	620	625	624	623	624	624	626	630	635	626	619	622	622	640	8.5 "	604	0.3 a.m.
7	622	625	625	626	625	622	627	626	626	627	628	630	a	a	a	a	a	a	a	a	a	a	a	a	a	634	8.16 a.m.	617	5.14 "
8	a	a	a	a	a	a	a	a	a	a	a	a	a	a	a	a	a	a	651	658	657	645	634	635	631	671	7.15 p.m.	624	10.7 p.m.
9	631	628	550	617	639	633	621	633	625	626	625	626	629	638	640	651	654	644	627	618	621	617	615	623	628	665	2.49 a.m.	506	2.19 a.m.
10	628	633	635	640	642	642	640	629	630	635	636	646	674	697	713+	708	b	683	650	639	637	639	633	625	626	713+	4.8 p.m.	620	11.39 p.m.
11	626	629	627	626	619	610	614	615	618	617	611	612	601	598	598	613	609	614	619	620	619	615	613	619	621	630	1.14 a.m.	592	1.43 "
12	621	621	620	620	617	613	604	611	609	610	612	624	643	661	671	653	633	630	637	635	616	601	619	607	600	683	1.25 p.m.	579	9.14 "
13	600	561	612	633	623	621	618	618	623	625	627	633	633	630	628	632	631	634	629	622	619	620	619	620	619	643	4.39 "	547	1.11 a.m.
14	619	618	618	617	620	620	620	622	625	625	629	628	629	627	627	629	625	626	626	629	629	627	629	629	629	632	7.15 "	609	3.51 "
15	629	629	630	632	635	635	633	634	636	637	640	642	644	652	661	672	662	649	646	647	644	641	638	639	638	680	2.50 "	627	0.47 "
16	638	635	633	630	635	633	634	637	637	642	648	661	679	694	694	674	675	688	667	650	641	625	632	638	640	711	2.28 "	623	9.20 p.m.
17	640	640	640	637	636	635	633	638	638	639	638	642	640	637	635	619	618	611	611	609	617	625	628	622	609	647	10.44 a.m.	606	6.56 "
18	609	607	614	621	624	625	631	629	626	626	622	621	624	627	628	628	627	623	639	645	643	634	625	630	644	648	6.53 p.m.	604	1.17 a.m.
19	644	647	644	634	a	a	a	a	a	a	a	a	a	a	a	a	a	a	a	a	a	a	a	a	a	649	0.58 a.m.	625	3.15 "
20	a	a	a	a	a	a	a	a	a	a	a	a	a	a	a	644	642	642	640	637	639	638	638	640	644	650	3.4 p.m.	629	10.17 p.m.
21	644	644	642	643	641	638	637	634	636	636	639	642	648	650	655	651	638	636	631	631	631	627	631	631	627	662	2.15 "	618	8.55 "
22	627	628	630	630	629	630	629	630	632	633	633	636	635	639	642	635	634	633	632	630	630	628	629	629	629	648	2.30 "	624	0.30 a.m.
23	629	629	628	627	627	626	623	622	620	622	625	626	625	627	629	633	636	645	630	625	625	624	619	621	624	653	5.44 "	615	8.37 "
24	624	622	622	621	620	619	616	616	616	621	628	656	b	b	686	711+	711+	688	651	644	627	624	611	601	612	711+	3-4 "	585	10.18 p.m.
25	612	615	614	616	616	599	611	604	597	624	674	674	710+	685	658	676	651	642	645	633	609	604	605	610	608	710+	Noon	574	4.50 a.m.
26	608	601	598	589	605	607	600	604	614	618	614	632	637	675	711+	696	665	689	655	617	626	615	611	600	597	711+	1.40 p.m.	579	3.3 "
27	597	610	619	613	608	606	599	608	612	616	624	618	627	638	650	632	630	622	615	612	610	606	604	603	607	665	1.50 "	587	2.52 "
28	607	606	607	607	605	604	606	605	608	609	612	615	618	620	618	615	614	613	612	608	610	609	608	605	606	626	0.25 "	599	11.23 p.m.
29	606	605	607	607	605	605	602	601	606	607	607	609	610	619	623	622	617	615	615	607	600	601	603	605	604	632	3.14 "	592	5.48 a.m.
30	604	603	602	599	599	602	603	602	604	601	605	604	610	610	612	608	597	602	601	599	599	596	595	600	598	619	2.19 "	587	9.30 p.m.
31	598	598	599	598	596	595	598	601	603	604	604	604	604	605	605	605	604	602	602	602	598	589	585	586	606	606	3.10 "	582	11.33 "

HOURLY VALUES.

HORIZONTAL FORCE, AUGUST, 1902.

Day.	H = .06 . . . C.G.S.																										Maximum reading and time.		Minimum reading and time.	
	Midt.	Forenoon.											Noon.	Afternoon.											Midt.					
		0.	1.	2.	3.	4.	5.	6.	7.	8.	9.	10.		11.	12.	1.	2.	3.	4.	5.	6.	7.	8.	9.		10.				
1	700	699	694	690	691	691	690	692	697	711	719	724	724	722	722	722	723	721	720	717	711	704	710	709	710	726	11.57 a.m.	687	3.5 a.m.	
2	710	711	710	709	708	712	714	714	714	714	714	717	716	740	739	737	735	731	729	723	720	720	707	713	706	745	2.10 p.m.	699	10.10 p.m.	
3	706	700	703	710	710	702	713	713	715	717	720	720	727	725	743	739	755	758	742	737	740	733	734	736	739	767	4.30 "	697	4.55 a.m.	
4	739	741	741	742	741	737	737	733	735	736	733	736	739	745	750	734	744	753	752	742	735	732	733	736	738	774	5.10 "	728	3.15 p.m.	
5	738	740	743	745	747	747	744	745	743	742	740	742	741	744	745	741	742	744	737	732	729	729	729	726	727	752	4.57 "	723	11.44 "	
6	727	724	724	725	723	724	726	726	725	725	727	726	730	734	739	741	741	740	734	732	733	732	732	725	719	748	3.45 "	715	11.46 "	
7	719	723	726	726	728	726	727	729	730	731	731	731	733	737	738	735	734	728	721	a	a	a	a	a	a	744	2.10 "	718	0.15 a.m.	
8	a	a	a	a	a	a	a	a	a	a	a	a	a	727	725	725	728	731	723	719	719	718	718	719	718	738	3.50 "	716	8.8 p.m.	
9	717	716	716	716	719	720	720	720	722	724	723	723	726	729	725	724	722	722	720	719	719	716	714	710	715	731	0.38 "	705	11.10 "	
10	715	713	716	713	719	720	718	716	721	725	726	724	728	730	729	726	726	726	725	725	722	722	721	721	720	733	1.21 "	708	2.39 a.m.	
11	720	720	720	719	716	716	715	718	722	729	737	b	765	784+	784+	775	764	739	734	737	728	726	725	727	725	784+	1-2 "	709	5.54 "	
12	725	720	722	717	717	724	725	725	733	740	745	750	750	754	750	743	744	749	750	753	753	748	745	741	733	758	0.5 "	702	3.30 "	
13	733	738	745	743	745	746	741	748	746	756	756	755	758	761	753	761	759	771	762	748	735	730	725	719	722	780	5.5 "	716	11.8 p.m.	
14	722	725	728	729	731	728	729	728	728	726	731	736	730	732	729	735	738	741	741	742	735	736	733	730	728	747	7.10 "	717	7.59 "	
15	728	717	715	714	708	709	712	713	714	718	724	716	720	722	722	728	726	725	725	721	709	700	683	683	691	730	2.53 "	685	9.54 "	
16	691	691	691	692	696	696	697	701	703	708	712	713	720	725	722	721	722	720	722	723	721	713	706	721	717	730	8.36 "	687	1.49 a.m.	
17	717	706	704	714	715	718	719	718	716	718	717	718	723	727	733	734	730	727	727	726	721	723	723	718	718	741	6.25 "	690	2.4 "	
18	718	719	712	701	689	705	711	709	712	731	742	744	767	769	757	802	806	773	753	726	734	709	690	689	680	824+	3.15 "	671	11.58 p.m.	
19	680	680	686	687	696	703	706	705	705	705	705	707	712	709	709	710	707	705	701	697	696	697	698	693	691	714	10.50 a.m.	670	0.5 a.m.	
20	691	689	687	687	686	688	684	683	688	687	695	701	694	689	685	678	675	672	674	684	686	680	677	682	684	705	10.46 "	664	9.16 p.m.	
21	693	693	693	695	693	691	693	692	695	700	708	b	723	728	713	711	712	707	708	712	707	692	696	699	699	760	0.37 p.m.	680	8.30 "	
22	699	692	653-	653-	653-	669	665	653-	680	653-	767+	767+	767+	767+	724	767+	742	743	713	696	653-	653-	707	697	692	767+	11 a.m. to 1 p.m.	653-	2.0 a.m.	
23	692	704	705	702	709	707	710	703	710	710	709	711	721	736	759	735	723	722	718	700	713	704	702	710	710	764+	2.10 p.m.	672	7.9 p.m.	
24	710	707	708	700	699	698	708	707	707	718	731	724	739	744	739	749	745	734	720	709	720	704	707	700	700	764+	3.20 "	673	4.56 a.m.	
25	700	705	701	696	699	709	705	708	706	712	722	728	731	732	727	722	721	715	716	712	710	671	697	707	709	743	0.47 "	655	9.22 p.m.	
26	709	705	704	692	705	701	688	697	707	715	725	705	712	721	730	718	720	718	716	712	714	714	709	706	703	749	9.53 a.m.	668	2.58 a.m.	
27	703	704	695	699	704	708	709	713	713	718	721	722	721	721	723	721	722	711	710	712	703	702	698	697	703	729	10.22 "	677	10.30 p.m.	
28	703	705	702	701	702	699	702	700	706	711	713	721	720	722	714	715	711	709	708	707	707	705	705	704	707	732	11.32 "	688	4.41 a.m.	
29	707	705	702	693	699	706	709	709	711	715	716	723	719	717	719	715	712	712	712	710	710	709	708	709	708	737	9.22 "	687	3.33 "	
30	708	703	705	702	701	701	703	701	707	710	715	724	723	719	721	718	718	717	715	708	709	710	712	713	713	730	11.30 "	695	7.26 "	
31	713	714	714	715	716	716	719	718	720	724	726	727	732	732	732	729	727	726	725	726	721	700	702	697	694	738	2.22 p.m.	657-	8.55 p.m.	

### HORIZONTAL FORCE, SEPTEMBER, 1902.

H = '06 . . . C.G.S.

Day.	H = '06 . . . C.G.S.																								Maximum reading and time.		Minimum reading and time.		
	Midt.	Forenoon.											Noon.	Afternoon.															Midt.
	0.	1.	2.	3.	4.	5.	6.	7.	8.	9.	10.	11.	12.	1.	2.	3.	4.	5.	6.	7.	8.	9.	10.	11.	12.				
1	694	700	694	690	690	681	690	705	703	716	723	723	723	719	712	727	739	720	714	711	704	705	706	706	705	746	0.3 p.m.	670	5.5 a.m.
2	705	707	705	701	701	702	704	706	707	710	714	724	723	730	737	743	750	719	730	717	700	697	701	693	690	765+	3.40 ..	675	11.15 p.m.
3	690	679	689	672	657-	676	668	689	703	709	729	740	b	745	765+	758	756	747	734	718	713	700	698	700	690	765+	2.20 ..	657-	4.0 a.m.
4	690	694	707	704	700	698	704	709	711	715	718	725	726	738	723	724	723	734	749	739	721	698	703	710	706	765	5.50 ..	683	0.25 ..
5	706	708	703	707	693	691	698	709	722	719	721	733	728	733	752	738	723	717	724	717	710	708	703	696	698	765+	2.40 ..	682	4.50 ..
6	698	700	704	705	703	702	703	702	703	707	712	713	718	716	717	720	728	725	724	704	700	703	700	693	670	739	4.17 ..	655	11.58 p.m.
7	670	670	697	701	699	690	701	700	706	707	718	725	723	731	741	754	736	731	715	709	705	704	702	699	694	765	2.44 ..	653-	1.2 a.m.
8	694	694	702	700	702	703	702	705	705	705	710	709	719	709	709	709	714	708	706	702	705	702	702	702	702	722	0.24 ..	688	0.30 ..
9	702	702	702	702	702	701	702	707	709	716	720	729	728	728	724	722	724	726	724	708	702	701	701	703	706	732	2.53 ..	695	5.32 ..
10	706	706	705	700	705	703	699	699	705	709	714	716	725	724	711	710	708	709	713	710	704	707	687	686	689	730	1.1 ..	669	10.10 p.m.
11	689	688	687	679	685	684	692	702	700	707	714	718	726	734	740	737	738	725	719	712	694	696	694	691	695	746	2.24 ..	669	2.38 a.m.
12	695	697	695	692	690	691	690	697	706	719	729	737	740	740	740	728	728	726	719	711	711	711	713	713	706	751	0.8 ..	684	4.30 ..
13	706	684	657-	672	673	662	671	694	711	720	727	b	b	732	752	754	743	722	725	719	711	707	708	708	710	764	2.23 ..	657-	1.40 ..
14	710	709	712	712	712	712	712	715	719	724	729	731	731	728	724	725	723	717	717	715	715	715	716	716	717	736	0.45 ..	707	1.20 ..
15	717	716	715	714	713	714	714	714	717	722	725	726	727	727	728	718	718	720	716	710	712	712	712	713	712	738	1.57 ..	708	6.47 p.m.
16	712	711	710	711	710	711	713	713	715	711	731	733	741	744	737	732	726	727	724	723	718	703	712	713	727	748	0.16 ..	687	9.13 ..
17	727	712	714	713	708	711	707	713	716	718	a	a	a	a	761	761	758	748	729	727	724	725	727	728	727	765+	3.30 ..	697	5.57 a.m.
18	727	722	717	702	707	709	721	737	735	729	740	747	735	739	744	739	733	734	729	729	728	729	727	699	696	758	10.32 a.m.	679	12.0 p.m.
19	696	730	729	727	733	738	722	716	734	746	750	754	a	a	a	a	a	a	a	a	a	a	a	a	a	765+	11.20 ..	673	0.10 a.m.
20	a	a	a	a	a	a	a	a	a	a	a	a	a	a	765+	765+	765+	765+	762	755	671	709	680	694	702	765+	2-4 p.m.	659-	8.20 p.m.
21	702	725	725	704	717	714	725	730	728	728	740	738	760	755	765+	765+	765+	757	741	736	734	725	734	727	701	765+	2-4 ..	668	11.45 ..
22	701	715	724	727	723	733	741	742	743	745	746	745	750	750	746	747	743	741	736	735	736	731	717	733	733	763	10.24 a.m.	694	9.59 ..
23	733	732	732	730	722	715	710	723	728	737	756	766+	766+	766+	766+	766+	760	766+	747	739	717	710	720	721	693	766+	11-3 p.m. and 5.0 p.m.	688	8.41 ..
24	693	702	727	716	705	718	710	716	713	724	741	739	757	755	758	761	759	758	745	740	735	735	732	733	731	766+	0.40 ..	674	0.27 a.m.
25	731	728	728	729	730	731	734	737	736	736	738	741	744	747	745	743	734	733	742	739	728	725	729	725	722	753	1.10 ..	719	12.0 p.m.
26	722	719	716	707	713	716	733	744	745	745	753	b	757	767+	761	750	753	755	747	739	730	727	725	729	731	767+	1.30 ..	687	3.30 a.m.
27	731	729	730	731	728	723	729	731	732	741	743	755	759	756	751	744	736	735	733	733	727	717	721	719	703	767+	0.50 ..	695	11.58 p.m.
28	703	707	719	718	716	713	716	720	722	724	728	b	751	744	739	748	750	741	730	724	721	a	a	a	a	756	2.32 ..	689	0.9 a.m.
29	a	a	a	a	a	a	a	a	a	a	a	738	742	755	748	741	746	738	734	730	728	726	725	725	724	765	0.55 ..	723	9.4 p.m.
30	724	723	723	722	721	719	729	731	727	735	744	735	734	746	732	738	731	723	721	723	716	714	713	711	707	766	10.3 a.m.	705	11.30 ..

F 2

HOURLY VALUES

HORIZONTAL FORCE, OCTOBER, 1902.

Day.	H = .06 . . . C.G.S.																								Maximum reading and time.		Minimum reading and time.			
	Midt.	Forenoon.										Noon.	Afternoon.										Midt.							
	0.	1.	2.	3.	4.	5.	6.	7.	8.	9.	10.	11.	12.	1.	2.	3.	4.	5.	6.	7.	8.	9.	10.	11.					12.	
1	725	727	712	a	a	a	a	a	a	a	a	784+	784+	784+	784+	784+	784+	778	757	749	735	729	726	736	784+	11 a.m-5 p.m.	685	2.30 a.m.		
2	736	737	728	719	714	717	720	a	a	a	a	754	766	771	774	778	771	765	756	747	732	728	731	731	733	786	3.2 p.m.	703	4.18 ..	
3	733	726	720	732	725	737	737	751	745	755	a	a	a	a	752	760	744	746	742	735	728	724	732	722	724	772	2.55 ..	705	6.16 ..	
4	724	727	727	727	722	704	724	725	742	744	755	745	763	748	750	760	779+	759	747	726	727	730	731	705	719	779+	4.0 ..	672-	11.20 p.m.	
5	719	729	729	727	725	733	736	724	732	745	755	764	773	779+	779+	786	762	760	754	750	744	745	745	744	746	779+	1-2 ..	698	6.58 a.m.	
6	746	744	741	744	744	746	752	752	749	762	765	768	772	771	769	768	771	767	762	756	756	749	740	748	746	775	1.18 ..	724	7.15 ..	
7	746	747	743	750	750	749	752	743	748	753	765	770	763	766	767	764	765	758	753	753	747	745	743	743	744	774	11.5 a.m.	733	6.51 ..	
8	744	744	745	745	745	746	747	749	754	757	757	763	764	757	766	763	763	762	751	744	743	740	739	741	736	777	2.25 p.m.	737	9.59 p.m.	
9	736	736	739	738	736	741	738	742	739	746	756	762	757	771	766	767	774	780+	766	764	754	741	738	735	738	780+	4.50 ..	724	3.30 a.m.	
10	738	736	727	728	728	730	733	742	752	757	761	768	767	770	765	768	770	772	765	760	756	748	747	745	745	780+	4.30 ..	719	3.58 ..	
11	745	744	744	745	745	743	749	750	759	767	772	779+	779+	779+	779+	779+	779+	778	754	748	751	743	719	727	690	779+	0-4 ..	686	11.58 p.m.	
12	690	716	737	710	707	698	710	702	703	724	768	778+	772	778+	778+	774	773	769	763	762	758	746	720	735	740	778+	1.0 ..	670-	6.20 a.m.	
13	740	736	739	742	742	736	754	756	756	758	756	755	763	762	763	760	760	757	757	748	746	741	745	742	736	770	11.59 a.m.	712	4.44 ..	
14	736	733	735	732	733	732	731	736	746	754	760	764	778	767	760	756	752	747	745	741	739	739	739	738	739	780+	0.20 p.m.	720	6.10 ..	
15	739	734	727	728	726	722	725	728	735	742	754	766	759	758	768	778+	778+	773	771	747	749	736	716	730	732	778+	3-4 ..	704	9.52 p.m.	
16	732	730	730	728	729	727	727	723	732	737	740	758	765	772	775	763	761	748	753	742	739	736	736	735	734	778	2.34 ..	709	5.46 a.m.	
17	734	733	733	733	736	738	726	730	724	735	743	748	753	764	759	755	759	770	768	751	731	736	734	730	734	776	5.10 ..	709	7.18 ..	
18	734	735	733	730	733	739	736	740	737	736	747	b	764	770	773	779+	779+	769	744	736	730	731	732	733	733	779+	3.20 ..	716	6.15 ..	
19	733	734	736	733	732	715	693	720	731	742	727	760	770	779+	779+	779+	773	748	744	741	739	736	733	739	737	779+	1-3 ..	681	5.59 ..	
20	737	737	737	733	736	740	745	743	742	748	747	758	762	763	771	779+	779+	774	751	741	735	740	742	727	717	779+	2.50 ..	710	11.52 p.m.	
21	717	732	741	736	741	743	744	736	750	751	756	755	766	762	769	767	770	756	747	740	740	741	737	733	731	778	3.30 ..	712	0.9 a.m.	
22	731	732	721	726	733	736	747	728	720	744	b	757	767	770	779+	779+	779	769	760	745	738	738	736	736	736	779+	2-3 ..	696	7.37 ..	
23	736	738	737	735	735	741	745	743	744	746	744	749	758	762	765	774	762	762	758	750	752	748	735	742	741	779+	2.52 ..	710	6.35 ..	
24	741	740	739	737	736	743	746	728	736	736	745	b	770	767	779+	768	759	741	738	750	746	742	742	739	737	779+	2.0 ..	686	7.2 ..	
25	737	734	723	721	693	689	696	695	740	743	779+	779+	779+	779+	779+	779+	779+	779+	762	742	717	721	725	714	779+	{ 10 a.m. to 6 p.m. }	669	6.21 ..		
26	714	731	728	727	730	737	753	720	720	742	747	775	779+	779+	779	768	766	770	766	765	757	747	741	728	730	779+	0-1 ..	698	7.42 ..	
27	730	721	708	693	707	702	706	728	735	737	749	778+	778+	778+	778+	778+	778+	773	740	723	730	703	729	727	778+	1-5 ..	675	6.2 ..		
28	727	688	670	669-	669-	695	693	763	749	724	763	743	779	780+	780+	780+	777	778	757	744	741	744	732	733	723	780+	1-3 ..	669-	3.30 ..	
29	723	723	708	713	716	706	729	719	706	722	b	755	780+	780+	780+	775	774	774	780+	767	734	728	726	730	724	780+	0-2 ..	691	2.47 ..	
30	724	727	723	704	682	672-	672-	672-	c	c	c	737	775	746	779	779+	779+	779+	779+	779+	779+	761	761	689	714	722	779+	3-7 ..	672-	5-6 ..
31	722	734	724	707	697	696	718	672-	674	716	b	753	764	778+	778+	778+	778+	778+	778+	778+	768	733	702	672-	675	778+	1-7 ..	672-	{ 7-8 11-12 p.m. }	

### HORIZONTAL FORCE, NOVEMBER, 1902.

H = '06 . . . C.G.S.																														
Day.	Midt.	Forenoon.										Noon.	Afternoon.										Midt.	Maximum reading and time.		Minimum reading and time.				
		0.	1.	2.	3.	4.	5.	6.	7.	8.	9.		10.	11.	12.	1.	2.	3.	4.	5.	6.	7.						8.	9.	10.
1	560	557-	557-	557-	557-	557-	557-	557-	557-	557-	636	664+	664+	664+	664+	664+	664+	656	654	635	645	648	648	613	621	621	664+	10 a.m.-3 p.m.	557-	1-8 a.m.
2	621	621	621	618	625	614	640	642	610	629	637	640	642	641	647	644	634	657	663+	652	639	616	619	612	611	663+	6.0 p.m.	598	8.1 ..	
3	611	615	611	583	577	576	569	585	605	621	636	640	663+	650	662	663+	658	647	648	649	627	629	623	624	622	663+	0-1 and 2-4 ..	560	3.2 ..	
4	622	624	623	617	621	634	627	613	619	628	644	641	648	648	644	641	641	642	641	620	627	621	624	627	625	655	0.55 ..	596	7.21 ..	
5	625	622	619	611	616	615	634	623	614	621	635	642	647	646	648	638	645	641	642	640	627	626	624	623	624	653	1.59 ..	601	4.58 ..	
6	624	621	621	618	617	616	614	614	631	636	632	638	648	648	652	660	653	647	647	642	633	628	624	627	624	663+	0.52 ..	604	6.11 ..	
7	624	625	622	615	598	580	557-	581	593	617	638	649	663	630	648	663+	650	626	625	611	621	615	618	623	625	663+	2.40 ..	557-	6.0 ..	
8	625	623	619	622	630	627	629	639	635	640	632	648	663	663+	663+	663+	663+	663+	663+	659	644	637	620	613	614	663+	1-6 ..	607	11.42 p.m.	
9	614	620	623	631	628	612	617	621	635	638	640	644	648	655	662	653	657	648	648	632	628	626	632	622	620	665	2.1 ..	590	5.4 a.m.	
10	620	620	619	616	629	636	647	638	634	639	635	637	639	663	663+	663+	663+	663+	663+	660	649	634	631	629	624	663+	2-6 ..	607	2.55 ..	
11	624	616	626	626	631	629	623	614	611	611	623	a	a	a	a	661+	659	661	650	638	631	634	636	633	635	639	661+	2.0 ..	587	7.10 ..
12	639	636	636	632	641	661+	656	640	647	a	a	a	a	659	661+	661	653	648	650	645	642	642	642	646	646	634	661+	5-6 a.m. 0-2 p.m.	626	2.58 ..
13	634	634	633	636	615	627	649	624	626	609	632	a	a	a	a	a	a	a	644	610	619	606	612	594	565-	660+	6.28 a.m.	565-	11.40 p.m.	
14	565-	583	585	565-	575	595	565-	600	616	611	616	622	626	647	656	662	673	639	646	640	613	607	589	589	582	661	3.36 p.m.	565-	6.0 a.m.	
15	582	580	575	590	608	608	615	615	603	658	648	650	645	652	660	658	665	659	636	630	617	614	588	607	591	685	4.23 ..	564-	2.23 ..	
16	591	601	598	596	611	595	635	593	575	632	597	623	640	631	614	626	635	629	600	598	613	625	604	616	606	664	6.10 a.m.	565-	5.20 ..	
17	606	577	594	598	612	603	610	636	614	588	609	623	660	672	672	687	671	646	618	628	621	601	605	613	611	701	2.27 p.m.	570	9.0 ..	
18	611	613	611	609	591	624	619	618	615	627	639	643	645	655	656	657	640	621	612	615	610	602	602	600	603	669	2.42 ..	573	3.58 ..	
19	603	600	599	588	595	583	567	577	574	587	617	624	628	651	656	661	674	642	636	615	606	601	626	609	591	691	3.17 ..	563-	6.25 ..	
20	591	599	592	598	612	623	605	584	566	581	610	614	626	629	656	664	671	656	645	626	612	607	603	609	607	677	3.30 ..	563-	8.30 ..	
21	607	606	601	590	563-	568	567	563-	563-	604	612	622	631	642	671	690	692	678	654	633	620	610	606	605	599	698	3.49 ..	563-	4-8 ..	
22	599	586	591	570	563-	575	599	615	563-	604	613	618	634	651	691	670	652	650	632	622	624	607	597	616	612	702	2.18 ..	563-	7.30 ..	
23	612	594	570	567	563-	563-	563-	563-	593	608	599	b	644	662	688	657	660	666	672	680	665	672	632	611	590	706	7.0 ..	563-	3-6 ..	
24	590	582	564	575	568	563-	563-	568	576	640	615	b	723+	723+	723+	723+	723+	699	683	634	601	660	608	563	563-	723+	0-4 ..	563-	4-6 ..	
25	563-	563-	563-	563-	563-	563-	563-	563-	563-	573	563-	646	687	696	703	715	715	723+	723+	720	706	690	654	618	604	723+	5-6 ..	563-	0-8 ..	
26	604	563-	564	563-	563-	563-	563-	563-	563-	605	653	688	668	669	702	697	666	652	638	636	656	638	618	605	609	722+	11.20 a.m.	563-	1-8 ..	
27	609	613	567	566-	566-	566-	566-	605	654	626	635	635	645	652	655	657	649	637	621	622	635	610	621	633	627	673	7.36 ..	566-	2-6 ..	
28	627	620	617	618	606	634	651	653	641	633	634	626	642	663	684	677	670	663	673	654	655	653	629	622	619	689	1.57 p.m.	595	3.38 ..	
29	619	621	619	611	609	594	615	604	614	640	654	667	657	671	680	668	660	662	678	668	655	653	647	620	626	696	1.35 ..	562	7.5 ..	
30	626	629	629	629	628	628	648	650	643	645	637	645	651	648	667	685	722+	713	700	677	666	653	660	637	627	722+	4.0 ..	623	0.18 and 0.42 ..	

HOURLY VALUES.



HORIZONTAL FORCE, DECEMBER, 1902.

Day.	H = '06... C.G.S.																										Maximum reading and time.		Minimum reading and time.	
	Midt.	Forenoon.											Noon.	Afternoon.											Midt.					
		0.	1.	2.	3.	4.	5.	6.	7.	8.	9.	10.		11.	12.	1.	2.	3.	4.	5.	6.	7.	8.	9.		10.				
1	417	411	409	414	380	382	368	379	371	413	423	437	440	453	466	466	486	466	447	446	439	435	430	416	397	498	4.20 p.m.	353	4.59 a.m.	
2	397	393	402	379	372	360	371	363	398	448	457	467	463	477	492	496	505	488	474	464	453	440	460	429	430	513+	4.10 ..	353-	4.50 ..	
3	430	416	399	392	386	377	415	430	411	423	438	439	449	450	454	452	456	437	411	417	415	432	413	420	416	477	1.30 ..	354	4.23 ..	
4	416	409	395	393	404	415	422	420	406	430	443	445	447	459	449	445	445	435	439	428	428	437	427	431	416	467	1.1 ..	364	7.32 ..	
5	416	415	410	410	384	357	357	372	399	388	417	419	444	451	449	444	449	458	456	466	447	462	452	440	430	488	7.23 ..	353-	4.20 ..	
6	430	429	423	422	411	434	426	466	455	404	416	448	448	443	449	456	469	456	443	443	427	445	446	435	430	498	7.2 a.m.	353-	9.2 ..	
7	430	426	426	428	416	398	446	435	437	445	455	462	467	473	472	472	453	451	449	454	449	439	442	425	426	478	1.10 p.m.	385	5.1 ..	
8	426	423	426	425	430	431	409	414	392	401	420	432	463	472	483	474	467	470	474	448	437	419	413	409	416	507	2.4 ..	367	8.37 ..	
9	416	415	412	416	411	422	400	367	377	402	427	433	470	456	452	431	435	440	432	435	429	452	423	394	427	485	11.55 a.m.	355	7.10 ..	
10	427	405	393	353-	353-	353-	373	441	404	417	434	449	484	481	458	469	504	467	457	468	425	416	397	385	382	514+	4.12 p.m.	353-	3-5 ..	
11	382	403	409	416	399	402	389	401	401	422	441	452	466	481	488	486	485	475	463	478	460	437	428	424	432	501	3.55 ..	354	5.17 ..	
12	432	425	433	422	423	410	412	373	469	416	442	472	456	486	486	481	479	482	469	450	450	436	441	434	431	512+	1.33 ..	353-	6.30 ..	
13	431	429	426	417	397	398	414	445	474	446	435	442	470	489	498	476	470	470	450	454	441	467	445	411	421	512+	7.24 a.m.	357-	6.8 ..	
14	421	422	411	413	379	385	408	404	418	433	443	455	453	458	445	451	451	452	458	460	439	428	437	441	437	487	0.29 p.m.	353-	5.10 ..	
15	437	436	431	425	423	441	435	444	428	441	472	475	479	512+	512+	479	464	454	439	434	434	451	451	438	422	512+	1-2 ..	359-	7.11 ..	
16	422	415	411	409	421	408	378	409	435	449	439	456	449	456	467	447	440	438	433	454	440	436	451	390	420	475	9.47 a.m.	352	5.36 ..	
17	420	426	418	387	360	360	392	397	402	396	430	427	449	484	504	473	468	466	462	445	435	431	433	436	436	512+	2.2 p.m.	353-	4.40 ..	
18	436	426	424	419	417	408	417	415	406	415	423	440	452	464	470	475	478	456	454	443	448	459	455	456	452	486	2.52 ..	385	6.27 ..	
19	452	444	433	425	419	426	453	449	448	411	447	b	477	504	511	512+	512+	502	497	463	456	452	456	445	409	512+	2-4 ..	388	8.44 ..	
20	409	422	413	425	413	428	400	424	447	455	472	465	479	497	501	501	482	479	488	465	455	445	454	438	440	513+	3.5 ..	363	4.28 ..	
21	440	436	428	426	441	418	441	438	441	459	465	482	486	495	495	481	481	472	452	440	437	448	449	455	453	511	1.10 ..	385	4.54 ..	
22	453	457	448	438	431	412	400	438	433	460	435	459	473	471	473	483	501	508	499	466	465	443	456	464	416	513+	4.40 ..	383	6.26 ..	
23	416	431	421	426	424	404	450	452	368	384	455	450	483	512+	456	510	512+	512+	512+	460	474	468	433	432	404	512+	3-6 ..	353-	5.5 ..	
24	404	398	391	416	401	461	420	353-	353-	439	476	463	463	502	475	490	473	492	470	465	469	427	441	454	438	512+	0.39 ..	353-	6-8 ..	
25	433	408	409	395	393	385	383	380	438	456	459	476	488	512+	512+	504	489	469	467	471	459	429	442	427	512+	2-3 ..	353	3.32 ..		
26	427	430	429	421	418	398	421	472	443	461	449	466	464	470	464	480	477	485	502	496	473	472	442	462	439	511+	7.5 ..	378	5.0 ..	
27	439	411	411	416	431	435	426	356	419	479	485	456	470	504	498	481	487	494	511+	511+	475	456	437	435	446	511+	6-7 ..	353-	6.40 ..	
28	446	442	434	434	408	400	432	477	472	501	470	480	510+	487	510+	510+	510+	510+	487	510+	466	460	471	446	d	510+	2-5 ..	360	5.22 ..	
29	d	d	d	d	d	d	d	441	467	470	483	484	b	475	498	485	482	480	477	492	492	476	472	462	454	518	1.28 ..	405	7.16 ..	
30	454	d	d	d	d	d	d	d	d	d	473	449	430	437	443	462	452	456	456	442	437	414	417	403	400	478	10.34 a.m.	393	11.42 p.m.	
31	400	408	398	388	383	392	399	394	424	420	421	(429)	436	438	445	434	425	423	420	407	398	413	412	410	417	464	1.8 p.m.	355-	6.53 a.m.	

HORIZONTAL FORCE, JANUARY, 1903.

H = '06... C.G.S.																															
Day.	Midt.	Forenoon.											Noon.	Afternoon.											Midt.	Maximum reading and time.		Minimum reading and time.			
		0.	1.	2.	3.	4.	5.	6.	7.	8.	9.	10.		11.	12.	1.	2.	3.	4.	5.	6.	7.	8.	9.						10.	11.
1	322	309	309	309	306	320	319	324	307	298	294	314	348	337	348	350	329	329	325	313	336	326	314	312	298	359	2.43 p.m.	275	8.39 a.m.		
2	298	c	c	c	c	c	c	c	c	c	c	c	416+	399	368	372	395	416+	408	393	377	387	401	401	401	416+	0.30 and 5 p.m.	298	0.0 "		
3	401	392	382	376	368	385	411	415+	415+	415+	415+	415+	415+	415+	415+	415+	415+	415+	415+	408	400	395	399	406	402	415+	10 a.m.-6 "	360	3.35 "		
4	402	397	382	386	389	394	385	363	403	418+	418+	417	418+	404	418+	418+	418+	418+	418+	418+	407	379	369	392	398	389	418+	2-6 p.m.	324	7.14 "	
5	389	390	378	387	382	373	379	378	415+	377	373	387	391	415+	415+	415+	415+	415+	414	415+	415+	415+	402	411	402	415+	1-5 "	343	4.33 "		
6	402	359	374	358	343	370	386	402	416+	411	399	416+	416+	416+	416+	416+	416+	416+	416+	416+	411	416+	413	416	410	416+	11 a.m.-5 p.m.	331	3.34 "		
7	410	398	385	372	344	363	371	377	388	396	400	371	343	370	379	352	379	379	379	369	360	359	354	333	318	417	10.29 a.m.	314	11.59 p.m.		
8	318	332	324	320	313	301	320	333	324	321	337	339	346	352	358	368	386	391	397	376	361	338	329	351	340	406	6.18 p.m.	279	5.15 a.m.		
9	340	341	338	332	329	321	305	319	a	a	a	a	361	373	385	379	391	392	406	375	335	342	357	327	330	419	6.0 "	280	6.13 "		
10	330	334	317	323	316	320	315	346	313	311	361	367	344	398	418+	402	407	396	418+	364	338	316	352	351	329	418+	6.5 "	258-	8.35 "		
11	329	315	280	312	313	331	331	313	350	334	343	355	363	375	374	367	381	388	382	359	353	345	337	331	332	405	11.46 a.m.	258-	7.30 "		
12	332	344	315	322	320	278	293	308	347	303	313	321	364	388	403	377	360	378	390	389	378	371	348	349	337	419	1.27 p.m.	258-	4.30 "		
13	337	334	323	307	315	307	343	355	344	323	322	326	355	360	356	365	361	361	351	332	335	340	332	347	335	374	3.26 "	265	6.12 "		
14	335	335	322	306	311	295	278	284	295	325	332	353	363	372	366	376	379	366	347	343	354	364	350	344	337	389	3.35 "	260	6.16 "		
15	337	331	334	332	343	342	358	369	314	299	323	344	359	357	369	387	412	391	389	369	350	334	352	354	335	418	4.1 "	284	8.30 "		
16	335	328	321	315	327	323	312	331	329	330	337	349	364	373	374	367	374	394	385	381	375	371	349	314	292	405	5.3 "	268	11.26 p.m.		
17	292	297	343	326	a	a	a	a	a	a	a	a	348	355	360	381	375	ad	ad	ad	ad	ad	ad	ad	ad	397	2.26 "	281	0.30 a.m.		
18	ad	ad	ad	ad	ad	ad	ad	ad	ad	ad	ad	ad	ad	ad	ad	ad	ad	ad	ad	ad	ad	ad	ad	ad	ad	ad	ad	ad	ad	ad	ad
19	ad	ad	ad	ad	ad	ad	ad	ad	ad	ad	ad	ad	ad	ad	ad	ad	ad	ad	ad	ad	ad	ad	ad	ad	ad	ad	ad	ad	ad	ad	ad
20	c	c	c	c	c	c	c	c	c	c	c	328	324	379+	379+	379+	379+	379+	379+	379+	379+	379+	312	298	298	379+	0-9 "	276-	1-4 a.m.		
21	298	323	327	d	d	d	d	c	379+	379+	379+	379+	358	371	368	379	379+	379+	379+	379+	372	375	377	368	354	379+	{ 8-11 a.m. } { 4-7 p.m. }	287	0.8 "		
22	354	343	358	351	352	351	342	361	375	380+	380+	375	380+	362	380+	373	373	380+	380	378	380+	379	371	376	368	380+	10.0 a.m.	324	5.13 "		
23	368	367	366	361	348	364	367	380+	370	345	331	b	318	329	338	364	380+	380	380+	380+	d	d	d	d	d	380+	{ 7.0 " } { 5-7 p.m. }	294	6.11 "		
24	c	c	c	281	286	303	314	320	361	381+	341	348	342	350	330	356	352	361	355	349	356	347	343	351	339	381+	9.0 a.m.	277-	0-2 "		
25	339	333	336	325	316	319	337	323	a	a	a	a	a	a	a	a	a	a	a	a	a	a	a	a	a	356	5.46 "	303	4.38 "		
26	a	a	a	a	a	a	a	a	a	a	a	a	a	a	a	a	a	a	a	a	a	a	a	a	a	a	a	a	a	a	a
27	a	a	a	a	a	a	a	a	a	a	a	a	a	350	366	367	314	292	267	258-	258-	258-	258-	258-	258-	371+	2.30 p.m.	258-	6 p.m.-Midt.		
28	258-	258-	258-	258-	258-	258-	258-	258-	258-	258-	258-	258-	a	a	a	a	a	a	352	336	333	340	354	334	318	366	6.20 "	258-	0-11 a.m.		
29	318	320	330	330	315	309	326	320	321	342	353	344	355	357	360	370+	370+	370+	365	351	348	339	321	320	326	370+	4-5 "	282	7.34 "		
30	326	324	331	322	325	330	343	346	343	340	336	b	362	370+	370+	370+	370+	370+	370+	370+	370+	364	330	327	323	370+	1-7 "	316	11.12 p.m.		
31	323	305	279	274	289	288	369+	369+	348	334	331	346	352	369+	364	365	369+	369+	369+	356	339	329	329	328	330	369+	6.40 a.m.	257-	2.35 a.m.		

HOURLY VALUES.

HORIZONTAL FORCE, FEBRUARY, 1903.

Day.	H = '06 . . . C.G.S.																								Maximum reading and time.	Minimum reading and time.			
	Midt.	Forenoon.											Noon.	Afternoon.													Midt.		
		0.	1.	2.	3.	4.	5.	6.	7.	8.	9.	10.		11.	12.	1.	2.	3.	4.	5.	6.	7.	8.	9.				10.	11.
1	335	330	314	292	305	302	327	325	298	324	345	341	356	363	373	369	372	364	368	345	340	340	337	330	341	374+	0-4 p.m.	277	7.36 a.m.
2	341	348	325	318	309	291	309	321	319	333	336	342	342	370	369	362	354	354	343	328	326	330	338	331	314	374+	1-3 "	264	4.58 "
3	314	320	324	325	336	347	357	354	328	346	345	a	a	a	a	a	a	a	356	348	346	331	329	330	320	374+	6.15 a.m.	300	0.6 "
4	320	323	322	321	321	333	341	346	341	340	334	346	357	352	373+	373	369	a	a	a	a	335	332	326	317	373+	1.30-3.30 p.m.	308	11.50 p.m.
5	317	320	321	322	311	304	321	354	340	329	349	347	338	351	353	326	340	367	370	353	324	341	332	326	320	376+	5.30 "	289	5.22 a.m.
6	320	316	305	306	296	334	330	333	333	334	337	337	355	376	376+	b	376+	376+	376+	367	364	349	335	339	325	376+	1.30-6 "	271	4.28 "
7	325	299	314	316	310	333	329	325	332	346	348	350	345	357	370	358	363	373	349	337	349	354	317	305	323	375+	5.10 "	289	1.5 "
8	323	322	322	316	314	339	361	325	292	297	322	358	346	374+	374+	374+	374+	374+	374+	373	374+	295	313	306	287	374+	1-6 "	259-	9.10 p.m.
9	287	274	283	253-	306	253-	253-	253-	331	330	358	373+	a	a	a	a	362	353	354	343	347	342	330	333	373+	Noon and 4.40 p.m.	261-	5-8 a.m.	
10	333	338	336	333	320	308	322	318	305	317	342	356	357	375+	375+	375+	375+	375+	359	348	336	341	335	322	330	375+	0.40-5 p.m.	268	7.44 "
11	330	332	331	328	334	337	316	323	299	337	297	b	356	359	375+	375+	375+	375+	375+	357	336	338	325	307	327	375+	2-6 p.m.	259-	8.20 "
12	327	323	317	328	333	337	323	339	295	307	338	343	371	374+	369	366	364	355	354	343	344	335	339	331	332	374+	0.40 "	272	7.48 "
13	332	330	328	325	318	289	277	332	a	a	a	a	375+	362	375+	375+	360	375+	353	336	327	342	344	325	321	375+	1.20-3.30 p.m.	274-	6.20 "
14	321	336	333	327	326	339	303	337	361	b	338	353	373	373+	350	359	357	357	347	336	340	350	332	319	314	373+	10.30 a.m. to 1 p.m.	282	6.4 "
15	314	318	304	317	318	325	297	291	323	320	350	b	373+	373+	373+	373+	373+	373+	373+	343	338	362	324	316	325	373+	0-6 "	275	6.57 "
16	325	302	270	262-	262-	297	330	351	325	353	340	343	340	356	359	364	369	369	363	345	336	337	332	323	327	375+	3.58 p.m. and 4.35 p.m.	262-	4.0 "
17	327	332	328	330	326	322	329	309	350	355	363	343	373	373+	373+	373+	370	373+	370	353	359	338	342	337	322	373+	2-5.40 "	290	7.8 "
18	322	308	300	303	322	331	338	332	328	339	351	356	358	354	366	373+	371	373+	356	360	352	345	343	334	332	373+	2.20 p.m. and 5.0 p.m.	263	7.42 "
19	332	332	332	333	331	321	326	331	328	348	350	350	354	364	366	364	365	357	363	367	363	345	341	337	342	372	3.26 "	305	8.26 "
20	342	336	334	331	323	315	340	343	348	335	346	355	363	360	355	373	373+	370	350	336	331	332	339	328	321	373+	4.0 "	309	5.19 "
21	321	333	325	317	318	332	337	373+	370	349	342	341	348	352	373+	334	366	a	a	a	350	352	341	339	328	373+	7.15 a.m. and 1.45 p.m.	312	2.44 "
22	328	293	319	302	320	343	337	358	349	340	345	353	355	374	374+	374+	374+	374+	374+	374+	360	323	310	305	294	374+	2-6 "	270	4.9 "
23	294	321	314	314	318	333	353	360	341	327	330	345	335	355	355	348	338	338	345	350	343	346	342	327	321	373	1.35 "	300	0.3 "
24	321	329	329	328	332	340	313	310	333	334	344	347	340	359	374+	374+	b	353	329	318	316	316	315	316	317	374+	3.0 "	289	6.33 "
25	317	317	314	311	296	311	302	309	327	324	328	327	331	334	373+	373+	373+	373+	373+	373+	359	327	314	299	303	373+	2-7 "	262-	6.15 "
26	303	303	313	308	310	312	317	332	330	321	315	319	339	350	332	338	330	325	326	326	314	316	319	317	316	369	1.0 "	289	0.41 "
27	316	316	317	318	319	320	316	300	293	315	319	341	346	344	349	372	371	360	348	332	324	321	317	317	317	374+	3.20 p.m. and 4.40 p.m.	270	7.27 "
28	317	315	316	316	315	310	312	318	322	328	332	337	340	341	346	354	346	337	327	321	324	315	314	319	318	358	3.5 "	300	9.13 p.m.

HOURLY VALUES.

HORIZONTAL FORCE, MARCH, 1903.

Day.	H = '06 . . . C.G.S.																								Maximum reading and time.		Minimum reading and time.			
	Midt.	Forenoon.											Noon.	Afternoon.															Midt.	
		0.	1.	2.	3.	4.	5.	6.	7.	8.	9.	10.		11.	12.	1.	2.	3.	4.	5.	6.	7.	8.	9.						10.
1	323	323	322	321	316	318	310	321	318	324	327	332	327	334	333	333	331	338	340	334	328	322	319	321	308	348	5.35 p.m.	308	5.41 a.m.	
2	308	296	294	286	288	313	309	336	336	325	324	349	364	365	358	371	378+	378+	366	363	341	325	317	318	318	378+	5.0 "	269	4.3 "	
3	318	321	322	319	307	310	302	311	316	342	366	377+	377+	369	356	377+	377+	363	345	337	328	326	322	321	321	377+	{ 11 a.m. and Noon }	284	6.3 "	
4	321	322	322	322	320	303	316	335	335	334	337	343	333	352	322	340	345	343	340	324	318	320	322	318	320	363	1.3 p.m.	286	5.52 "	
5	320	318	318	318	318	318	316	318	323	343	341	335	345	377+	377+	377+	349	342	324	322	314	299	287	279	276	377+	2 and 3 p.m.	267-	10.18 p.m.	
6	276	274	278	267-	302	306	323	325	346	337	343	366	358	350	352	332	341	339	340	325	319	325	329	326	324	371	11.15 a.m.	267-	3.0 a.m.	
7	324	323	323	324	326	316	322	312	317	326	349	366	376+	376+	376+	376+	376+	363	375	367	359	320	314	288	294	376+	1-4 p.m.	277	10.36 p.m.	
8	294	324	311	286	286	321	321	326	334	340	351	351	369	376+	376+	376+	376+	376+	370	346	339	344	335	324	310	306	376+	1-4 "	266-	3.20 a.m.
9	306	294	309	289	299	286	274	285	291	323	341	376+	349	376+	376+	376+	376+	371	350	339	338	329	318	320	320	376+	1.20-5 "	270-	5-6 "	
10	320	322	325	322	320	325	325	321	326	328	340	344	346	354	349	352	352	351	343	345	348	338	333	327	318	370	0.55 "	293	8.34 "	
11	318	313	301	298	305	295	300	305	339	348	338	345	346	349	358	362	355	359	356	345	335	328	326	316	320	376+	2.26 "	262-	6.55 "	
12	320	324	322	312	313	308	317	322	335	328	345	347	355	347	362	376+	376+	376+	371	340	334	338	324	329	314	376+	3-5 "	296	4.3 "	
13	314	307	314	301	265-	324	337	306	326	322	339	333	344	377+	377+	377+	377+	365	341	340	327	317	319	306	282	377+	1-4 "	265-	3.20 "	
14	282	292	286	267-	288	282	323	339	347	334	346	335	347	341	351	349	346	359	341	331	333	316	307	332	325	378+	11.30 a.m.	267-	{ 3.20 a.m. and 4.30 a.m. }	
15	325	320	327	314	320	332	312	335	338	335	336	344	340	357	350	370	370	349	336	345	325	323	324	320	312	378+	3.35 p.m.	271-	3.30 "	
16	312	306	276	295	315	299	298	322	323	335	334	340	346	350	343	342	351	350	347	348	335	330	328	327	327	360	1.0 "	267-	2.0 "	
17	327	329	329	330	329	328	322	328	333	342	351	351	355	353	352	351	345	345	346	341	336	334	333	334	333	358	11.4 a.m.	309	6.27 "	
18	333	332	332	334	333	331	329	338	338	343	346	350	349	349	350	342	344	346	349	342	338	335	333	332	332	356	10.54 "	324	5.31 "	
19	332	331	329	330	330	330	337	329	339	334	342	353	359	351	365	348	366	361	356	339	337	327	326	324	322	378	1.55 p.m.	304	6.44 "	
20	322	327	324	328	317	316	314	323	323	333	339	344	346	352	350	352	348	348	343	344	340	329	321	317	321	369	0.43 "	285	5.43 "	
21	321	325	331	331	331	330	325	334	322	340	345	344	340	359	367	377+	377+	365	349	332	331	333	330	329	328	377+	4.0 "	306	5.58 "	
22	328	323	318	322	327	334	320	314	322	336	344	359	363	361	370	359	355	352	341	336	337	338	331	329	331	378+	1.45 "	292	6.10 "	
23	331	329	330	332	327	332	342	331	304	323	295	a	a	c	367	b	b	356	342	336	325	331	326	328	326	378+	About 1 p.m.	277	7.54 "	
24	326	327	328	330	334	335	336	336	323	333	335	353	355	358	355	359	368	370	377	349	345	331	331	328	326	378+	6.5 p.m.	316	7.46 "	
25	326	331	330	331	333	334	339	339	337	335	c	351	c	354	355	354	349	347	343	338	334	331	328	330	363	2.55 "	319	0.15 "		
26	330	329	330	330	330	331	333	333	336	337	342	342	352	352	354	347	345	346	343	333	331	330	331	323	322	359	1.55 "	319	11.24 p.m.	
27	322	322	329	328	325	325	326	328	333	339	344	347	349	348	357	349	344	337	331	329	328	328	327	326	326	366	2.0 "	316	4.29 a.m.	
28	326	325	322	323	320	321	325	326	329	338	341	350	354	354	353	348	343	337	333	329	330	328	316	315	320	359	{ 0.38 and 1.50 p.m. }	298	9.55 p.m.	
29	320	322	319	320	322	313	326	330	331	333	335	345	348	356	377+	350	361	342	349	338	325	314	314	314	318	377+	{ 1.40 and 2.0 p.m. }	306	5.21 a.m.	
30	318	315	310	296	278	285	302	298	329	332	341	366	372	378+	378+	378+	357	353	333	331	331	322	316	323	319	378+	1-3 p.m.	269	3.35 "	
31	319	320	325	326	327	328	334	337	335	326	332	349	378+	361	358	349	351	356	363	350	342	340	340	309	334	378+	Noon	292	11.18 p.m.	

HOURLY VALUES.

HORIZONTAL FORCE, APRIL, 1903.

H = '05 . . . C.G.S.

Day.	H = '05 . . . C.G.S.																								Maximum reading and time.	Minimum reading and time.			
	Midt.	Forenoon.											Noon.	Afternoon.													Midt.		
		0.	1.	2.	3.	4.	5.	6.	7.	8.	9.	10.		11.	12.	1.	2.	3.	4.	5.	6.	7.	8.	9.				10.	11.
1	529	525	512	503	524	529	512	536	553	557	569	566	576	576	579	573	565	546	543	543	538	535	533	529	529	579+	{ 1.20 and 2.20 p.m. }	483	3.32 a.m.
2	529	529	533	534	535	538	541	540	539	543	564	569	580+	580+	566	563	b	550	553	553	528	535	526	529	519	580+	10 a.m.-2 p.m.	515	11.55 p.m.
3	519	534	542	543	520	526	518	537	539	545	548	571	579+	579+	579+	566	542	544	547	539	535	536	533	515	533	579+	10 ,, -3 ,,	502	11.1 ,,
4	533	537	529	527	531	531	529	533	543	551	553	555	568	574	575	580+	567	572	561	555	542	544	539	540	531	580+	0-5 p.m.	521	{ 3.14 a.m. and 5.24 a.m. }
5	531	531	533	533	536	538	527	547	542	545	548	550	553	578	571	582+	582+	582+	580	553	535	532	531	538	538	582+	3-5 ,,	509	6.15 ,,
6	536	506	466	490	514	541	549	550	552	550	546	563	561	579+	579+	579+	579+	510	544	542	579+	557	509	435-	435-	579+	1-4 ,,	435-	{ 10.0 p.m. to Midt. }
7	435-	435-	557	553	551	574	563	563	555	544	530	528	542	545	558	558	565	570	565	558	552	550	537	530	530	579+	{ 3.10 a.m. and 5.45 a.m. }	435-	0-1 a.m.
8	530	485	499	522	518	533	543	543	554	558	556	565	563	556	560	550	552	554	553	554	543	544	540	540	540	579+	9.3 ,,	469	1.7 ,,
9	540	540	532	523	531	534	536	536	544	544	580+	580+	580+	580+	580+	580	580+	580+	571	566	521	493	537	533	531	580+	10 a.m.-7 p.m.	465	8.25 p.m.
10	531	531	526	533	523	491	527	534	553	534	555	552	565	563	568	558	551	544	561	546	511	539	534	526	538	581+	0-2 p.m.	450	5.2 a.m.
11	538	509	508	509	500	527	531	525	536	539	548	565	551	555	565	571	571	559	563	541	544	542	513	465	540	580+	{ 2-3 p.m. and 4-5 p.m. }	447	11.14 p.m.
12	540	542	543	540	532	536	542	537	544	540	537	555	569	579+	578	576	566	553	538	534	535	536	537	532	533	579+	0-5 ,,	516	5.6 a.m.
13	533	532	523	528	525	528	521	531	529	540	545	555	567	578	567	574	563	570	562	569	543	511	528	539	540	582+	{ 0-1 p.m. and 3-4 p.m. }	502	8.35 p.m.
14	540	540	539	534	534	534	527	531	536	534	534	543	551	549	554	549	549	545	546	540	535	532	533	533	530	568	2.7 ,,	516	6.18 a.m.
15	530	518	530	529	533	536	537	535	543	539	538	550	546	558	554	566	552	553	549	538	531	475	514	483	501	576	10.51 a.m.	438-	9.6 p.m.
16	501	475	454	466	469	501	508	529	550	541	549	549	547	551	558	548	545	540	537	531	534	532	530	532	531	572	2.15 p.m.	430	2.25 a.m.
17	531	531	531	533	534	536	540	539	536	530	530	529	539	546	545	546	544	542	539	537	534	532	534	532	532	554	1.25 ,,	524	11.2 ,,
18	532	527	504	490	471	486	515	538	547	544	543	546	550	551	549	548	549	541	536	539	538	517	517	473	492	560	1.10 ,,	435	11.42 p.m.
19	492	523	505	513	487	500	519	528	535	544	545	552	553	563	549	562	555	556	548	539	536	536	535	534	534	580+	1.5 ,,	463	4.19 a.m.
20	534	534	533	532	533	536	540	538	537	535	538	541	536	540	539	547	556	555	553	545	533	528	525	531	531	561	5.52 ,,	519	10.7 p.m.
21	531	529	532	527	533	529	526	534	532	533	534	537	540	547	550	563	560	546	545	534	524	528	539	528	532	574	2.42 ,,	505	8.10 ,,
22	532	534	528	531	529	530	527	531	534	537	542	544	548	546	546	546	539	537	533	532	533	530	530	530	539	558	11.45 a.m.	521	5.28 a.m.
23	539	531	531	532	529	522	531	524	529	533	537	536	545	545	550	546	542	535	536	531	530	529	532	527	511	556	2.5 p.m.	515	4.57 ,,
24	511	518	513	518	513	514	522	526	531	539	542	546	545	554	a	a	a	a	a	a	a	a	a	a	a	573	0.36 ,,	496	0.22 ,,
25	a	a	a	a	a	a	a	a	a	a	a	a	a	a	560	548	554	538	538	536	520	531	508	498	511	567	1.53 ,,	476	10.15 p.m.
26	511	530	532	529	559	531	534	532	532	532	540	543	550	544	547	535	532	532	532	530	528	529	526	524	525	562	0.15 ,,	504	0.2 a.m.
27	525	523	526	527	528	523	519	524	522	543	555	559	581+	581+	a	a	a	a	a	a	a	a	a	a	a	581+	0-1 ,,	500	4.54 ,,
28	a	a	a	a	a	a	a	a	a	a	a	a	a	a	a	565	558	547	541	528	527	526	526	527	526	578+	2.38 ,,	523	8.15 p.m.
29	526	521	521	515	518	517	520	524	529	535	540	539	545	553	552	542	530	537	537	531	522	518	515	496	517	562	1.46 ,,	486	10.54 ,,
30	517	513	514	508	509	514	518	524	527	529	538	530	537	531	528	529	528	530	526	520	521	521	520	514	515	559	9.42 a.m.	496	3.47 a.m.

HORIZONTAL FORCE, MAY, 1903.

Day.	H = '06 . . . C.G.S.																								Maximum reading and time.		Minimum reading and time.			
	Midt.	Forenoon.											Noon.	Afternoon.															Midt.	
		0.	1.	2.	3.	4.	5.	6.	7.	8.	9.	10.		11.	12.	1.	2.	3.	4.	5.	6.	7.	8.	9.						10.
1	670	664	664	667	663	674	680	684	680	681	681	684	687	684	686	692	691	691	694	682	677	669	666	673	668	700	4.45 p.m.	649	9.35 p.m.	
2	668	669	673	672	672	666	665	670	674	675	678	691	686	689	690	693	688	686	684	679	672	671	665	663	667	701	3.4 "	657	10.54 "	
3	667	668	668	665	663	668	667	667	674	682	686	675	680	683	678	678	679	677	675	672	671	671	670	670	670	693	9.38 a.m.	655	4.5 a.m.	
4	670	670	672	673	672	672	673	673	674	674	674	674	680	674	674	685	687	691	691	677	672	656	645	665	662	698	5.44 p.m.	626	9.40 p.m.	
5	662	661	662	663	670	669	646	658	659	673	703	715	734+	734+	734+	734+	726	698	694	667	662	661	661	663	663	734+	Noon-3 p.m.	638	6.6 a.m.	
6	663	665	662	660	666	668	669	665	662	663	672	687	684	694	693	680	709	703	735+	722	683	677	623	630	655	735+	5-7 p.m.	585	10-11 p.m.	
7	655	668	654	656	643	655	662	662	671	679	703	710	701	733+	716	710	699	694	691	680	686	657	645	656	665	733+	10-11 a.m. and 0-2 p.m.	630	9.17 "	
8	665	657	658	664	653	640	661	646	676	676	670	675	676	679	687	683	695	677	676	681	670	656	671	672	675	721	3.33 "	613	8.49 "	
9	675	675	669	668	661	661	655	663	675	681	690	691	696	703	708	715	703	675	678	674	673	675	671	662	660	723	3.49 "	633	5.57 a.m.	
10	660	669	661	657	653	662	663	673	680	679	683	682	686	685	686	685	692	696	683	680	677	678	674	673	671	709	4.58 "	640	3.9 "	
11	671	669	664	667	671	672	675	673	677	677	682	681	682	688	683	684	684	685	684	680	673	670	675	675	676	693	0.43 "	654	2.22 "	
12	676	669	670	675	672	675	673	677	675	681	684	682	683	684	677	682	680	678	679	678	673	673	682	673	670	689	1.6 "	680	1.22 "	
13	670	673	673	675	678	675	671	677	674	680	679	685	a	a	a	a	a	a	a	a	a	a	a	a	a	691	11.22 a.m.	665	6.16 "	
14	a	a	a	a	a	a	a	a	a	a	a	a	a	a	a	a	a	a	a	a	a	a	a	a	a	a	a	a	a	a
15	a	a	a	a	a	a	a	a	a	a	a	a	a	a	a	a	a	a	a	a	a	a	a	a	a	a	a	a	a	a
16	a	a	a	a	a	a	a	a	a	a	a	a	a	a	a	a	a	a	a	a	a	a	a	a	a	a	a	a	a	a
17	a	a	a	a	a	a	a	a	a	a	a	a	a	a	a	a	a	a	a	a	a	a	a	a	a	a	a	a	a	a
18	a	a	a	a	a	a	a	a	a	a	a	a	a	a	a	673	676	684	681	669	665	665	663	659	659	660	697	4.3 p.m.	652	9.57 p.m.
19	660	662	664	663	659	664	665	665	666	666	669	667	668	673	670	669	667	666	669	663	666	655	659	660	656	680	1.4 "	645	9.7 "	
20	656	658	651	646	651	663	661	663	663	665	667	669	667	666	669	667	667	665	664	664	661	661	661	663	664	678	0.26 "	642	4.22 a.m.	
21	664	664	663	663	665	664	664	662	664	665	667	667	670	677	683	682	683	675	676	669	663	659	658	660	661	704	2.17 "	654	10.54 p.m.	
22	661	657	651	658	654	663	657	658	662	a	a	a	670	667	673	674	677	667	673	667	644	663	660	659	663	687	4.6 "	615	8.10 "	
23	663	663	659	663	661	659	665	666	667	670	677	667	a	a	a	a	a	a	a	a	a	a	a	a	a	688	9.25 a.m.	640	4.45 a.m.	
24	a	a	a	a	a	a	a	a	a	a	a	a	a	a	a	674	670	668	667	666	667	c	a	a	a	685	1.41 p.m.	660	4.12 p.m.	
25	a	a	a	a	a	a	a	a	a	a	a	a	a	a	b	704	689	688	684	681	672	675	656	c	a	723	1.21 "	647	9.6 "	
26	a	a	a	a	a	a	a	a	a	a	a	a	a	a	b	692	689	686	698	680	672	a	a	a	a	704	4.43 "	661	7.25 "	
27	a	a	a	a	a	a	a	a	a	a	a	a	a	a	b	690	684	a	a	a	a	a	a	a	a	695	2.10 "	677	1.3 "	
28	a	a	a	a	a	a	a	a	a	a	a	a	a	a	710	732+	732+	732+	732+	704	688	a	a	664	630	658	732+	2-5 "	600	10.50 "
29	658	663	664	659	669	670	668	669	668	675	680	694	b	b	682	712	686	682	675	673	661	648	647	664	649	733+	3.6 "	622	8.39 "	
30	649	662	656	659	663	658	670	662	667	675	683	691	685	694	708	712	710	708	694	680	675	657	641	644	657	721	4.22 "	622	10.31 "	
31	657	646	653	647	650	656	657	663	659	668	682	689	713	716	686	664	666	664	665	666	665	664	658	659	659	728	0.42 "	635	3.22 a.m.	

62

HOURLY VALUES.

### HORIZONTAL FORCE, JUNE, 1903.

H = .06 . . . C.G.S.

Day.	Forenoon.												Afternoon.												Midt.	Maximum reading and time.		Minimum reading and time.				
	Midt.	0.	1.	2.	3.	4.	5.	6.	7.	8.	9.	10.	11.	12.	1.	2.	3.	4.	5.	6.	7.	8.	9.	10.						11.	12.	
1	734	733	743	740	742	742	744	743	744	742	743	746	743	743	743	744	744	746	741	745	744	739	714	696	678	758	11.7 a.m. 1-2 p.m. and 5-6 p.m. Noon-3 p.m.	662	11.58 p.m.			
2	678	671	690	711	716	727	716	754	747	733	749	767	773	809+	809+	794	801	809+	809+	789	758	690	732	711	669	809+		1-2 p.m. and 3-5 p.m. 11.52 a.m.	655-	1.22 a.m.		
3	669	751	698	745	716	697	710	732	753	748	748	795	805	b	808+	796	770	767	762	764	749	734	740	738	738	808+			1-2 p.m. and 3-5 p.m. 11.52 a.m.	660-	0.22 "	
4	738	723	700	697	731	735	746	743	741	743	743	741	745	794	806	789	807+	766	737	739	740	732	741	726	726	807+	11.52 a.m.			675	3.21 "	
5	726	740	739	741	737	747	732	731	739	742	750	772	776	767	749	759	749	753	752	759	740	744	739	738	736	789		11.47 "		714	6.26 "	
6	736	738	727	719	731	723	742	743	743	744	744	743	743	746	743	744	740	741	743	742	743	741	739	736	740	748			5.38 p.m.	710	2.58 "	
7	740	741	739	740	736	737	738	740	739	741	749	747	751	748	748	742	752	761	760	748	737	736	739	734	730	773	5.13 "			719	11.28 p.m.	
8	730	736	738	740	738	735	738	738	740	740	739	739	738	740	746	748	751	755	756	745	744	a	a	a	a	765		1.45 "		727	1.7 a.m.	
9	a	a	a	a	a	a	a	a	a	a	a	a	a	a	766	758	745	736	730	736	728	729	730	727	713	772			5.11 a.m. and 9.40 a.m. 0.12 p.m.	710	11.30 p.m.	
10	713	709	732	740	736	727	718	729	735	735	736	740	743	742	742	738	735	737	736	735	716	726	729	728	732	761	2.38 "			701	5.54 a.m.	
11	732	730	726	721	725	730	726	724	729	733	734	738	743	733	742	739	733	738	730	725	722	722	725	726	728	752		2.38 "		715	2.26 "	
12	728	727	728	725	720	725	722	724	730	731	731	732	733	740	745	749	738	731	727	727	726	723	722	723	721	763			4.6 "	714	6.23 "	
13	721	724	728	721	719	712	718	728	729	736	735	736	738	734	736	738	741	740	739	732	728	725	724	726	725	749	4.10 "			700	5.31 "	
14	725	725	723	727	718	722	725	725	726	729	733	734	734	735	736	733	736	734	730	725	725	724	711	722	722	744		2.7 a.m.		698	10.3 p.m.	
15	722	725	728	729	729	726	727	726	728	727	728	729	728	732	a	a	a	a	a	a	a	a	a	a	a	736			5.30 p.m.	718	4.37 a.m.	
16	a	a	a	a	a	a	a	a	a	a	a	a	a	a	a	731	729	727	729	729	727	727	728	730	716	704	737			1.7 "	695	11.59 p.m.
17	704	713	734	725	727	719	719	725	725	746	774	773	776	787	780	774	763	765	746	735	735	722	718	719	726	799	1-3 "	687			0.15 a.m.	
18	726	722	720	729	735	a	a	a	a	a	a	a	a	809+	809+	809	782	769	757	733	725	722	726	720	714	809+		3.20 "	704		11.59 p.m.	
19	714	687	725	725	724	738	729	727	730	739	738	739	747	747	744	784	797	783	748	712	736	740	730	718	716	808+			0.44 "	657-	7.4 "	
20	716	711	712	700	713	707	714	725	738	736	749	752	754	776	766	756	755	763	751	724	739	733	729	733	730	797	3.44 "			672	2.55 a.m.	
21	730	722	726	711	730	710	725	728	728	741	741	744	745	751	748	754	771	744	738	733	734	736	728	723	709	781		11 a.m.-3 p.m.		692	2.50 "	
22	709	692	718	711	725	717	730	719	730	747	758	767	806	807	791	768	742	744	767	773	737	734	730	723	682	810+			1.12 p.m.	669	2.53 a.m.	
23	682	706	697	691	689	735	717	730	737	741	758	764	756	784	782	784	778	759	743	744	731	712	711	730	729	802	2-4 "			669	11.55 p.m.	
24	729	724	724	696	706	726	718	715	731	742	752	775	776	780	799	808	761	746	752	742	721	730	731	721	703	809+		0.45 "		668	0.4 a.m.	
25	703	713	724	721	723	717	712	723	734	741	744	737	747	762	745	737	739	736	743	726	733	729	726	722	721	765			10.5 a.m.	692	3.47 "	
26	721	726	723	723	723	728	726	727	732	735	737	737	735	735	730	731	730	732	734	730	730	726	726	726	726	740	1.10 p.m.			717	0.2 "	
27	726	727	727	728	728	729	727	728	728	729	730	731	731	732	730	731	730	729	728	728	728	729	729	730	730	734		8.27 "		720	6.20 "	
28	730	730	731	731	730	730	730	730	729	730	730	730	733	730	736	735	729	738	734	735	728	742	724	722	722	778			5.5 "	676	4.53 "	
29	722	712	711	709	693	688	712	692	696	733	735	742	745	740	738	741	747	797	784	757	733	730	724	716	676	809+	1-4 "			669	7.58 p.m.	
30	676	669	660-	680	660-	692	660-	694	682	725	728	716	758	807	808+	796	769	744	732	725	732	727	689	697	679	808+		1-4 "		660-	7.24 a.m.	

HORIZONTAL FORCE, JULY, 1903.

H = '06... C.G.S.																														
Day.	Midt.	Forenoon.											Noon.	Afternoon.											Midt.	Maximum reading and time.		Minimum reading and time.		
		0.	1.	2.	3.	4.	5.	6.	7.	8.	9.	10.		11.	12.	1.	2.	3.	4.	5.	6.	7.	8.	9.		10.	11.	12.		
1	734	769	772	789	737	724	736	770	778	788	770	782	798	812	809	816	786	787	800	815	801	790	764	740	766	841	3.4 p.m.	712	4.44 a.m.	
2	766	767	782	769	776	766	772	765	773	774	791	788	802	805	838	802	798	786	782	780	779	773	780	776	779	865+	1.43 "	743	5.55 "	
3	779	778	777	778	773	769	775	775	776	790	778	796	799	802	815	851	826	807	808	789	780	780	779	777	776	865+	2.35 "	750	8.46 "	
4	776	782	784	782	788	782	784	784	783	782	784	790	791	791	791	795	790	793	794	795	790	784	778	779	783	806	2.38 "	761	9.56 p.m.	
5	783	787	785	781	778	779	779	773	780	785	785	790	788	788	786	788	789	789	785	785	783	783	784	782	784	802	9.56 a.m. 0.20 p.m. and 3.10 p.m.	762	7.2 a.m.	
6	784	785	783	784	781	777	775	782	777	794	814	810	850	832	797	866+	861	800	799	789	772	782	792	783	769	866+	6.59 "	720-	8.20 p.m.	
7	769	780	759	761	787	782	787	785	785	786	789	790	794	792	799	794	790	799	793	797	783	783	783	781	782	806	6.59 "	728	3.7 a.m.	
8	782	786	783	785	780	781	782	781	784	787	790	789	793	792	794	795	791	790	785	784	785	784	784	782	784	810	2.32 "	774	5.9 "	
9	784	779	778	778	775	778	769	775	784	782	785	787	785	788	792	790	785	785	783	786	791	780	789	782	784	796	7.56 "	760	6.39 "	
10	784	775	782	784	758	761	773	779	778	779	796	805	806	785	787	803	810	803	798	790	786	778	767	780	782	836	3.21 "	743	4.1 "	
11	782	772	754	713-	713-	736	767	776	787	791	792	794	806	806	841	856	853	843	811	786	801	791	777	779	778	864+	3.30 "	713-	3-4 "	
12	778	775	766	741	754	783	761	754	777	775	778	785	808	807	805	804	786	785	786	786	784	775	777	778	778	822	11.46 a.m.	727	6.19 "	
13	778	779	776	772	778	779	780	783	783	781	782	784	783	784	785	787	787	785	790	799	803	772	775	773	775	835	7.29 p.m.	749	2.44 "	
14	775	777	778	774	770	777	780	778	775	780	789	787	796	794	799	789	786	786	785	781	774	771	771	773	776	827	0.47 "	762	2.56 "	
15	776	771	760	753	760	764	780	777	772	775	785	805	788	793	788	808	829	812	786	778	781	774	770	777	754	846	4.9 "	734	2.37 "	
16	754	775	780	777	774	765	a	a	a	a	a	a	a	a	a	a	a	a	a	a	a	a	a	a	a	789	1.28 a.m.	749	0.14 "	
17	a	a	a	a	a	a	a	a	a	a	a	a	a	a	a	a	a	a	a	a	a	a	a	a	a	789	1.28 a.m.	749	0.14 "	
18	771	771	733	727	748	762	772	776	778	780	780	780	783	780	783	796	812	838	826	777	774	768	767	762	759	864	4.48 "	714-	3.8 a.m.	
19	759	715-	748	746	732	764	760	766	777	780	787	794	799	824	812	829	863+	856	811	785	807	757	747	780	749	863+	3.40 p.m. and 4.20 p.m.	715-	0.40 "	
20	749	730	727	739	715-	715-	752	768	769	779	778	797	800	783	794	793	786	787	790	785	786	772	739	763	771	815	10.52 a.m.	715-	9.20 p.m. 9.50 "	
21	771	774	779	774	773	765	776	770	774	775	786	778	782	786	791	804	852	816	777	778	771	770	770	774	863+	4.15 p.m.	740	4.30 a.m. 5.4 "		
22	774	775	771	765	764	760	774	772	772	774	775	781	784	787	801	789	793	794	783	772	774	773	773	761	766	813	2.3 "	748	4.44 "	
23	766	772	774	769	769	766	771	771	775	774	775	776	775	774	774	774	786	781	781	774	769	769	754	759	766	796	4.19 "	743	10.27 p.m.	
24	766	763	758	761	756	756	758	764	767	770	775	778	785	784	774	769	768	767	769	766	764	764	766	767	766	797	0.43 "	744	6.12 a.m.	
25	766	769	768	766	766	765	767	767	767	767	769	772	771	773	775	776	778	776	771	772	771	767	764	753	760	788	5.1 "	742	11.23 p.m.	
26	760	765	768	763	752	759	750	758	758	764	758	778	788	809	792	789	795	789	864+	806	777	746	739	767	713-	864+	5.50 p.m. and 6.20 p.m.	713-	9.20 p.m. and 11.59 p.m.	
27	713-	758	776	778	738	773	748	778	763	786	764	794	808	802	794	802	799	792	800	786	786	743	746	767	761	833	0.10 "	713-	0.5 a.m. and 9.20 p.m.	
28	761	767	713-	741	747	761	737	752	764	766	765	786	807	824	864+	850	795	816	822	828	751	789	756	715	729	864+	2.0 p.m. and 2.40 p.m.	713-	1-5 a.m. and 11-12 p.m.	
29	729	757	758	748	762	748	760	764	757	786	774	770	783	787	784	797	824	822	793	762	778	771	770	771	765	836	4.38 "	710	4.52 a.m.	
30	765	765	768	757	762	775	760	765	767	781	789	792	781	788	c	c	c	c	c	c	c	c	c	c	c	c	c	c	c	c
31	c	c	c	763	766	765	765	769	773	773	770	769	773	782	c	c	c	c	c	c	c	c	c	c	c	c	c	c	c	c

HOURLY VALUES.



HORIZONTAL FORCE, AUGUST, 1903.

Day.	H = '06 . . . C.G.S.																								Maximum reading and time.	Minimum reading and time.			
	Midt.	Forenoon.										Noon.	Afternoon.										Midt.						
		0.	1.	2.	3.	4.	5.	6.	7.	8.	9.		10.	11.	12.	1.	2.	3.	4.	5.	6.	7.		8.			9.	10.	11.
1	c	c	c	c	c	c	a	a	a	a	a	a	a	a	876	877	882	853	850	847	839	836	839	840	822				
2	822	794	837	830	842	828	829	841	841	843	851	849	849	855	846	848	849	844	841	839	841	839	841	833	824	865	0.33 p.m.	787-	1.10 a.m.
3	824	834	834	838	844	842	839	844	845	844	847	846	847	846	849	850	850	849	851	845	842	837	841	832	839	857	3.7 "	810	0.24 "
4	839	838	842	841	842	840	842	842	843	846	847	850	848	848	842	845	846	848	852	848	844	836	835	831	835	857	5.46 "	825	10.32 p.m.
5	835	835	828	813	813	821	831	830	823	838	852	863	893	941+	929	941+	938	861	838	829	832	834	836	837	839	941+	1-4 "	790	3.49 a.m.
6	839	838	839	841	837	838	842	841	844	846	849	848	851	851	852	854	858	848	849	848	846	841	839	834	811	861	4.27 "	792	11.55 p.m.
7	811	837	834	836	833	830	833	832	834	841	845	843	846	851	851	857	853	845	843	838	838	845	837	838	837	863	2.36 "	796	0.1 a.m.
8	837	836	837	839	838	831	833	837	837	839	840	853	864	879	875	868	844	830	844	831	829	834	835	834	821	901	2.31 "	820	5.23 "
9	821	799	785-	792	820	826	822	833	847	848	860	844	852	848	843	c	c	c	c	c	c	833	839	834	835	829			
10	829	818	797	785-	785-	820	830	839	845	843	851	843	858	894	900	891	c	c	c	c	c	c	a	a	a				
11	a	a	a	a	a	a	a	a	a	a	a	a	a	c	c	c	c	c	c	c	c	814	790-	797	817	802			
12	802	790-	790-	790-	807	790-	796	835	836	830	843	855	844	c	c	c	c	c	c	c	c	a	a	a	a				
13	a	a	a	a	a	a	a	a	a	a	a	a	a	a	889	938+	867	838	830	829	830	829	790-	832	820				
14	820	820	820	824	805	808	798	795	819	822	839	874	888	872	889	886	882	849	832	817	812	840	804	803	785-	938+	0.8 p.m.	785-	5.40 a.m. and 6.55 a.m.
15	790-	790-	790-	829	811	825	823	827	816	820	829	841	847	858	886	905	932	884	834	828	835	821	826	825	822	942+	3.58 "	790-	0-4 "
16	822	816	812	825	825	823	827	827	831	832	838	832	839	840	844	849	848	841	833	832	828	827	827	826	829	869	4.5 p.m.	802	7.8 "
17	829	806	785-	811	813	810	793	792	831	846	842	851	869	842	844	840	843	850	854	846	785-	827	829	828	829	881	11.42 a.m.	785-	1-3 "
18	829	829	831	827	829	831	832	832	831	832	833	830	836	839	844	851	847	860	845	836	835	823	823	804	792	879	5.5 p.m.	787-	11.20 p.m.
19	792	815	822	825	823	824	819	823	829	832	841	840	837	838	847	847	846	835	834	833	827	827	828	829	830	851	1.37 "	787-	0.20 a.m.
20	830	830	830	829	831	828	830	831	832	832	834	833	838	838	836	840	842	856	880	862	847	831	824	826	826	891	6.1 "	820	9.31 p.m.
21	826	808	788-	788-	814	840	823	822	830	839	843	863	875	892	883	899	889	838	823	835	832	822	818	788-	813	919	3.12 "	788-	1-4 a.m. and 10-12 p.m.
22	813	830	823	819	808	804	785-	785-	820	812	850	919	932	939+	939+	939+	934	907	846	838	785-	797	785-	785-	939+	11 a.m.-4 p.m.	785-	5-9 a.m. and 7-12 p.m.	
23	785-	785-	817	803	815	800	802	811	817	825	839	811	841	858	867	885	861	835	829	842	814	835	830	796	805	909	3.13 p.m.	785-	0-11 a.m. and 8-12 p.m.
24	805	814	820	788-	788-	788-	788-	825	814	830	844	869	855	866	939+	882	844	877	851	838	819	807	801	798	804	939+	2.0 "	788-	2-7 a.m. and 9-10 p.m.
25	804	796	788-	812	805	816	821	823	818	824	820	820	829	840	855	888	850	857	850	825	820	821	788-	801	815	915	3.4 "	788-	1.30 a.m. and 10.40 p.m.
26	815	797	795	796	801	806	811	822	826	829	852	850	785-	861	901	851	834	831	868	841	865	815	831	785-	785-	939+	2.7 "	785-	10.40 a.m. and 11-12 p.m.
27	785-	785-	785-	785-	785-	785-	785-	818	804	819	827	837	853	861	846	901	910	895	892	845	826	785-	798	801	807	940+	3.31 "	785-	0-6 a.m. and 9.20 p.m.
28	807	807	805	785-	803	804	816	817	821	818	825	834	855	861	864	876	864	841	837	824	822	810	816	815	809	887	3.9 "	785-	3.0 a.m. and 5.20 a.m.
29	809	803	785-	785-	785-	785-	795	805	819	820	828	830	824	829	830	834	833	834	830	822	819	824	814	811	814	844	9.56 a.m.	785-	2-5.30 a.m.
30	814	812	810	812	817	803	813	813	810	815	817	819	852	830	835	830	829	834	838	838	813	830	799	804	785-	870	11.37 "	785-	10.20 p.m. and 12 p.m.
31	785-	785-	785-	785-	804	808	817	814	805	815	840	818	842	835	852	849	844	847	837	829	827	822	819	821	820	871	9.56 "	785-	0-3.40 a.m.

### HORIZONTAL FORCE, SEPTEMBER, 1903.

H = '06 . . . C.G.S.																																
Day.	Midt.	Forenoon.											Noon.	Afternoon.											Midt.	Maximum reading and time.	Minimum reading and time.					
		0.	1.	2.	3.	4.	5.	6.	7.	8.	9.	10.		11.	12.	1.	2.	3.	4.	5.	6.	7.	8.	9.				10.	11.	12.		
1	870	856	867	863	864	873	869	870	871	881	881	880	883	883	892	885	886	882	880	878	876	869	875	866	863	904	2.4 p.m.	853	0.58 a.m.			
2	863	861	848	835-	846	863	870	867	876	875	880	888	888	881	874	877	876	873	872	872	873	877	848	835-	869	903	0.16 "	835-	{ 2-5 "			
3	869	878	871	852	839	835-	860	860	869	880	885	891	891	896	906	903	899	887	882	884	874	873	866	864	859	917	3.34 "	835-	{ 10-12 p.m.			
4	859	861	866	865	864	865	864	866	872	874	875	874	879	882	886	883	888	883	884	877	871	841	863	870	868	895	3.29 "	835-	8.50 p.m.			
5	868	869	861	835-	853	835-	855	883	874	900	928	894	919	919	931	911	898	894	881	867	876	863	853	835-	835-	956	{ 10.1 a.m. and 2.34 p.m. }	835-	{ 3.0 a.m.			
6	835-	835-	835-	835-	835-	867	872	866	868	862	867	880	884	892	887	903	954	981	934	900	882	884	895	875	871	857	847	860	988+	1.40 "	835-	{ 11-12 p.m.
7	860	863	866	862	865	868	868	862	867	869	878	882	882	889	899	921	899	876	873	866	864	864	865	866	865	947	3.30 "	852	6.59 "			
8	865	864	864	852	849	835-	849	845	835-	851	892	939	990+	926	898	878	875	882	863	868	868	845	844	844	844	990+	11.20-Noon	835-	4-9 "			
9	844	854	850	854	851	835	852	873	875	871	876	788	912	967	944	971	930	921	891	868	877	861	853	845	856	989+	1.40 p.m.	835-	10.10 p.m.			
10	856	853	835-	854	855	837	855	866	876	873	884	902	985+	927	927	901	a	a	a	a	a	a	a	a	a	985+	Noon	835-	2.5 a.m.			
11	a	a	a	a	a	a	a	a	a	a	a	a	a	a	a	a	a	a	a	a	a	a	a	a	a	a	a	a	a	a	a	
12	a	a	a	a	a	a	a	a	a	a	a	a	a	a	a	a	a	a	a	a	a	a	a	a	a	a	a	a	a	a	a	
13	a	a	a	a	a	a	a	a	a	a	a	a	a	a	a	a	a	a	a	a	a	a	a	a	a	a	a	a	a	a	a	
14	a	a	a	a	a	a	a	a	a	a	a	a	a	a	a	a	a	a	a	a	a	a	a	a	a	a	a	a	a	a	a	
15	a	a	a	a	a	a	a	a	a	a	a	a	a	a	a	a	a	a	a	a	a	a	a	a	a	a	a	a	a	a	a	
16	a	a	a	a	a	a	a	a	a	a	a	a	a	a	a	a	a	a	a	a	a	a	a	a	a	a	a	a	a	a	a	
17	a	a	a	a	a	a	a	a	a	a	a	a	a	a	a	a	a	a	a	a	a	a	a	a	a	a	a	a	a	a	a	
18	a	a	a	a	a	a	a	a	a	a	a	a	a	a	a	a	a	a	a	a	a	a	a	a	a	a	a	a	a	a	a	
19	a	a	a	a	a	a	a	a	a	a	a	a	a	a	a	a	a	a	a	a	a	a	a	a	a	a	a	a	a	a	a	
20	a	a	a	a	a	a	a	a	a	a	a	a	a	a	a	a	a	a	a	a	a	a	a	a	a	a	a	a	a	a	a	
21	846	842	830-	845	847	836	830-	853	842	876	845	873	901	927	928	933	934	903	c	c	858	863	851	848	830-	961	3.54 "	830-	11.0 p.m.			
22	830-	830-	830-	830-	831	830-	840	854	869	865	872	859	873	888	893	905	897	900	885	878	860	871	847	830-	839	914	4.43 "	830-	{ 1.30-6.30 a.m. and 12 p.m.			
23	839	830-	830-	836	845	830-	830-	839	860	830-	856	858	920	929	962	985+	978	882	898	878	857	840	830-	830-	830-	985+	2-4 "	830-	{ 0-5 a.m.			
24	830-	830-	830-	850	856	865	872	830-	830-	857	885	912	951	907	899	886	930	b	936	901	882	881	830-	830-	843	982	0.8 "	830-	{ 10.10-11.40 p.m.			
25	843	844	851	849	843	859	860	856	862	863	886	866	886	880	885	897	899	881	a	a	a	a	a	a	a	909	4.15 "	830	{ 1-6.40 a.m.			
26	a	a	a	a	a	a	a	a	a	a	a	a	a	a	a	a	a	a	a	a	a	a	a	a	a	a	a	a	a	a	a	
27	a	a	a	a	a	a	a	a	a	a	a	a	a	a	a	a	a	a	a	a	a	a	a	a	a	a	a	a	a	a	a	
28	a	a	a	a	a	a	a	a	a	a	a	a	a	a	a	a	a	a	a	a	a	a	a	a	a	a	a	a	a	a	a	
29	a	a	a	a	a	a	a	a	a	a	a	a	a	a	a	879	923	959	892	900	876	850	830-	830-	830-	830-	982	3.52 p.m.	830-	{ 9.20-12 p.m.		
30	830-	830-	830-	830-	830-	840	836	830-	841	857	862	877	879	890	903	956	924	895	904	884	853	851	847	847	847	983+	3.18 "	830-	{ 0-2 a.m.			

HOURLY VALUES.

HORIZONTAL FORCE, OCTOBER, 1903.

H = '06 . . . C.G.S.

Day.	Midt.	Forenoon.											Noon.	Afternoon.											Midt.	Maximum reading and time.		Minimum reading and time.	
		0.	1.	2.	3.	4.	5.	6.	7.	8.	9.	10.		11.	12.	1.	2.	3.	4.	5.	6.	7.	8.	9.		10.	11.	12.	
1	867	860	864	850-	850-	850-	850-	850-	862	877	892	912	913	902	896	905	925	936	907	880	872	850-	850-	850-	950	5.56 p.m.	850-	3-8 a.m., 10-12 p.m.	
2	850-	850-	861	857	850-	863	872	894	850-	858	894	931	919	896	889	885	887	884	886	877	850-	850-	850-	850-	975	11.28 a.m.	850-	0-4 ,, 8-12 ,,	
3	850-	850-	850-	850-	872	887	895	901	894	881	873	879	892	916	918	912	a	a	a	a	a	a	a	a	938	1.28 p.m.	850-	0-3 a.m.	
4	a	a	a	a	a	a	a	a	a	a	a	a	a	a	a	a	a	a	a	a	a	a	a	a	a	a	a	a	a
5	a	a	a	a	a	a	a	a	a	a	a	a	a	a	a	a	a	a	a	a	a	a	a	a	a	a	a	a	a
6	a	a	a	a	a	a	a	a	a	a	a	a	a	a	a	a	a	a	a	a	a	a	a	a	a	a	a	a	a
7	860	850-	850-	850-	850-	850-	850-	887	884	870	910	897	919	930	931	937	937	912	865	877	859	873	859	857	968	4.36 ,,	850-	1-7 a.m.	
8	857	855	855	857	850-	850-	850-	868	859	898	884	937	919	900	951	*1004+	979	a	a	a	a	a	a	a	1004+	3.20 ,,	850-	3-7 ,,	
9	a	a	a	a	a	a	a	a	a	a	a	a	a	a	a	a	a	a	a	a	a	a	a	a	a	a	a	a	a
10	a	a	a	a	a	a	a	a	a	a	a	a	a	a	a	a	a	a	a	a	a	a	a	a	a	a	a	a	a
11	a	a	a	a	a	a	a	a	a	a	a	a	a	a	a	a	a	a	a	a	a	a	a	a	a	a	a	a	a
12	a	a	a	a	a	a	a	a	a	a	a	a	a	a	a	a	a	a	a	a	a	a	a	a	a	a	a	a	a
13	850-	850-	850-	850-	850-	850-	850-	850-	892	935	969	1007+	1007+	1007+	1007+	981	946	a	a	a	a	a	a	a	1007+	0-2 ,,	850-	0-8 a.m.	
14	a	a	a	a	a	a	a	a	a	a	a	a	a	a	a	a	a	a	a	a	a	a	a	a	a	a	a	a	a
15	a	a	a	a	a	a	a	a	a	a	a	a	a	a	a	a	a	a	a	a	a	a	a	a	a	a	a	a	a
16	850-	850-	850-	865	868	869	874	880	879	850-	860	902	894	914	908	911	903	897	883	873	873	883	850-	850-	930	1.4 ,,	850-	0-2 a.m., 8.40 a.m., 9.40 and 11 p.m.	
17	865	863	850-	854	850-	850-	850-	881	876	870	868	882	923	917	930	912	911	897	894	875	872	888	855	850-	955	1.30 ,,	850-	2-6 a.m., 9.30-11 p.m.	
18	873	859	858	863	865	850-	850-	865	850-	879	883	890	906	915	956	994	997	922	a	a	a	a	a	a	1005+	3.35 ,,	850-	5-6 a.m.	
19	a	a	a	a	a	a	a	a	a	a	a	a	a	a	a	a	a	a	a	a	a	a	a	a	a	a	a	a	a
20	a	a	a	a	a	a	a	a	a	a	a	a	a	a	a	a	a	a	a	a	a	a	a	a	a	a	a	a	a
21	a	a	a	a	a	a	a	a	a	a	a	a	a	a	a	a	a	a	a	a	a	a	a	a	a	a	a	a	a
22	a	a	a	a	a	a	a	a	a	a	a	a	a	a	a	a	a	a	a	a	a	a	a	a	a	a	a	a	a
23	a	a	a	a	a	a	a	a	a	a	a	a	a	a	a	a	a	a	a	a	a	a	a	a	a	a	a	a	a
24	a	a	a	a	a	a	a	a	a	a	a	a	a	a	a	a	a	a	a	a	a	a	a	a	a	a	a	a	a
25	a	a	a	a	a	a	a	a	a	a	a	a	a	a	a	a	a	a	a	a	a	a	a	a	a	a	a	a	a
26	a	a	a	a	a	a	a	a	a	a	a	a	a	a	a	a	a	a	a	a	a	a	a	a	a	a	a	a	a
27	850-	850-	850-	850-	850-	850-	850-	850-	850-	850-	855	891	921	922	948	947	964	954	929	892	908	886	850-	850-	977	{ 4.18 and 4.45 p.m. }	850-	0-9 a.m., 11.20 ,,	
28	850-	850-	850-	850-	858	856	850-	850-	850-	850-	866	874	898	899	942	957	936	a	a	a	a	a	a	a	980	2.21 p.m.	850-	0-9 a.m.	
29	a	a	a	a	a	a	a	a	a	a	a	a	a	a	a	a	a	a	a	a	a	a	a	a	a	a	a	a	a
30	a	a	a	a	a	a	a	a	a	a	a	a	a	a	a	a	a	a	a	a	a	a	a	a	a	a	a	a	a
31	a	a	a	a	a	a	a	a	a	a	a	a	a	a	a	a	a	a	a	a	a	a	a	a	a	a	a	a	a

\* This is to be interpreted as '07004+, and similarly in similar cases below.

NOVEMBER, 1903.

H = '06 . . . C.G.S.																													
Day.	Midt.	Forenoon.											Noon.	Afternoon.											Midt.	Maximum reading and time.		Minimum reading and time.	
		0.	1.	2.	3.	4.	5.	6.	7.	8.	9.	10.		11.	12.	1.	2.	3.	4.	5.	6.	7.	8.	9.					
1	a	a	a	a	a	a	a	a	a	a	a	a	a	a	a	a	a	a	805	768	782	770	755	745-	745-	878	5.3 p.m.	745-	11-12 p.m.
2	745-	745-	745-	745-	745-	745-	745-	777	745-	780	757	812	811	847	825	792	814	805	829	813	761	745-	750	745-	745-	885	6.24 "	745-	{ 0-6 a.m. 9-12 p.m.
3	745-	745-	745-	745-	745-	745-	745-	757	745-	745-	745-	809	851	a	a	a	a	a	a	a	a	a	a	a	a	898+	0.35 "	745-	0-6 a.m.
4	a	a	a	a	a	a	a	a	a	a	a	a	a	a	a	a	a	a	a	a	a	a	a	a	a				
5	a	a	a	a	a	a	a	a	a	a	a	884	864	820	837	880	774	759	745-	745-	745-	745-	766	745-	745-	898+	2.30 "	745-	6-12 p.m.
6	745-	745-	745-	745-	745-	784	812	798	775	745-	745-	745-	760	767	796	779	773	796	769	756	745-	745-	745-	745-	745-	834	{ 6.8 a.m. and 6.44 a.m.	745-	{ 0-4 a.m. 9-11 " 8-12 p.m.
7	745-	745-	745-	745-	745-	745-	745-	745-	745-	745-	745-	a	a	a	a	a	a	a	a	a	a	a	a	a	a	768	6.10 "	745-	{ 0-6 a.m. 7-10 " 10 a.m.-Noon. 8-12 p.m.
8	a	a	a	a	a	a	a	a	a	a	a	745-	745-	745-	784	809	830	835	829	802	780	745-	745-	745-	745-	839	5.8 p.m.	745-	
9	745-	745-	745-	745-	745-	745-	745-	745-	745-	745-	745-	a	a	a	a	a	a	a	a	a	a	a	a	a	a				

DECEMBER, 1903.

H = '06 . . . C.G.S.																													
Day.	Midt.	Forenoon.											Noon.	Afternoon.											Midt.	Maximum reading and time.		Minimum reading and time.	
		0.	1.	2.	3.	4.	5.	6.	7.	8.	9.	10.		11.	12.	1.	2.	3.	4.	5.	6.	7.	8.	9.					
12	a	a	a	a	a	a	a	a	a	a	a	a	a	566	576	581	566	585	568	520-	520-	520-	520-	520-	520-	595	4.51 p.m.	520-	8-12 p.m.
13	520-	520-	520-	520-	520-	520-	520-	536	534	538	546	569	b	571	626	632	614	581	579	571	551	533	520-	530	520-	651	3.4 "	520-	{ 0-6 a.m. 9.20-12 p.m.
14	520-	520-	520-	520-	520-	520-	520-	520-	520-	520-	644	621	580	593	595	636	680+	677	553	520-	520-	520-	546	539	540	680+	{ 10-11 a.m. and 7-9 p.m.	520-	{ 0-9 a.m. 7-9 p.m.
15	540	520-	520-	520-	520-	520-	520-	587	545	520-	531	534	520-	541	571	596	615	586	559	541	520-	520-	520-	520-	520-	636	3.55 "	520-	{ 0.40-5 a.m. 7.20-12 p.m.
16	520-	520-	520-	520-	520-	520-	520-	520-	595	520-	550	594	616	a	a	a	a	a	a	a	a	a	a	a	a	636	0.15 "	520-	0-7 a.m.

JANUARY, 1904.

H = '06 . . . C.G.S.																														
Day.	Midt.	Forenoon.											Noon.	Afternoon.											Midt.	Maximum reading and time.		Minimum reading and time.		
		0.	1.	2.	3.	4.	5.	6.	7.	8.	9.	10.		11.	12.	1.	2.	3.	4.	5.	6.	7.	8.	9.						10.
7	a	a	a	a	a	a	a	a	a	a	a	a	a	a	a	a	a	359	394	313	313	376	321	295-	295-	385	8.44 p.m.	295-	10-12 p.m.	
8	295-	295-	308	295-	308	295-	315	320	311	320	315	329	345	354	a	a	a	350	344	326	313	321	314	295-	295-	375	0.34 "	295-	{ 0-1.40 a.m. 4.20 a.m. 11-12 p.m.	
9	295-	314	295-	295-	295-	318	295-	355	a	a	a	a	a	a	a	a	a	376	372	314	295-	319	a	a	a	391	5.10 "	295-	{ 2-4 a.m. 7-8 p.m.	
10	a	a	a	a	a	a	a	a	a	a	a	a	a	a	a	a	a	a	a	a	a	a	a	a	a					
11	a	a	a	a	a	a	a	a	a	a	a	a	a	a	a	a	a	a	a	a	a	a	a	a	a					
12	a	a	a	a	a	a	a	a	a	a	a	a	a	456+	321	363	407	374	388	415	367	a	a	a	a	456+	Noon	307	0.59 p.m.	
13	a	a	a	a	a	a	a	a	a	a	a	a	a	a	a	a	a	a	a	a	a	a	a	a	a					
14	a	a	a	a	a	a	a	a	a	a	a	a	a	a	a	a	a	a	a	a	a	a	a	a	a					
15	a	a	a	a	a	a	a	a	a	a	a	a	a	349	349	344	366	366	349	a	a	a	a	a	a	378	3.10 p.m.	335	1.44 p.m.	
16	a	a	a	a	a	a	a	a	a	a	a	a	a	413	457+	457+	457+	457+	457+	457+	453	411	380	348	295-	295-	457+	1-6 "	295-	11-12 "
17	295-	295-	295-	295-	295-	295-	295-	295-	295-	351	379	374	377	420	406	403	360	390	393	348	a	a	a	a	a	446	1.12 p.m.	295-	0-8 a.m.	

HOURLY VALUES.

VERTICAL FORCE, MARCH, 1902.

Day.	V = .7... C.G.S.																								Maximum reading and time.	Minimum reading and time.					
	Midt.	Forenoon.											Noon.	Afternoon.													Midt.				
	0.	1.	2.	3.	4.	5.	6.	7.	8.	9.	10.	11.	12.	1.	2.	3.	4.	5.	6.	7.	8.	9.	10.	11.			12.				
1	a	a	a	a	a	a	a	a	a	a	a	a	a	a	a	a	a	a	a	a	a	a	a	a	a						
2	a	a	a	a	a	a	a	a	a	a	a	a	a	a	a	a	a	a	a	a	a	a	a	a	a	a					
3	a	a	a	a	a	a	a	a	a	a	a	a	a	a	a	a	a	a	a	a	a	a	a	a	a	a					
4	a	a	a	a	a	a	a	a	a	a	a	a	a	a	a	a	a	a	a	a	a	a	a	a	a	a					
5	a	a	a	a	a	a	a	a	a	a	a	a	a	a	a	a	a	a	a	a	a	a	a	a	a	a					
6	a	a	a	a	a	a	a	a	a	a	a	a	a	a	a	a	a	a	a	a	a	a	a	a	a	a					
7	a	a	a	a	a	a	a	a	a	a	a	a	a	a	a	a	a	a	a	a	a	a	a	a	a	a					
8	a	a	a	a	a	a	a	a	a	a	a	a	a	a	a	a	a	a	a	a	a	a	a	a	a	a					
9	a	a	a	a	a	a	a	a	a	a	a	a	a	a	a	a	a	a	a	a	a	a	a	a	a	a					
10	a	a	a	a	a	a	a	a	a	a	a	a	a	a	a	a	a	a	a	a	a	a	a	a	a	a					
11	a	a	a	a	a	a	a	a	a	a	a	a	a	a	a	a	a	a	a	a	a	a	a	a	a	a					
12	a	a	a	a	a	a	a	a	a	a	a	a	a	a	a	a	a	a	a	a	a	a	a	a	a	a					
13	a	a	a	a	a	a	a	a	a	a	a	a	a	a	a	a	a	a	a	a	a	a	a	a	a	a					
14	a	a	a	a	a	a	a	a	a	a	a	a	a	a	a	a	a	a	a	a	a	a	a	a	a	a					
15	a	a	a	a	a	a	a	a	a	a	a	a	a	a	a	a	a	a	a	a	a	a	a	a	a	118	118	116			
16	116	115	111	111	111	110	110	110	111	110	106	103	103	101	101	101	105	105	106	106	108	106	106	106	106	106	1162	0.0 a.m.	1000	1.15 p.m.	
17	106	106	106	106	108	108	106	a'	a	a	a	a	093	095	095	096	096	098	098	100	100	101	101	101	101	101	1033	1.0 a.m.	0942	3.45 p.m.	
18	101	101	101	100	101	100	100	098	100	100	100	096	096	095	093	090	090	092	093	095	095	093	095	095	095	095	0984	7.25 ..	0896	2.30 ..	
19	096	098	096	098	096	098	096	098	098	096	096	096	095	093	093	090	092	093	095	095	093	095	095	095	095	095	0972	6.45 ..	0914	0.10 ..	
20	095	095	095	095	095	095	096	096	096	095	095	093	093	093	095	096	096	096	096	096	096	096	096	096	096	096					
21	095	095	095	096	095	095	093	095	093	093	093	096	096	095	096	a'	a'	a'	a'	a'	a'	a'	a'	a'	a'	a'	a				
22	a	a	a	a	a	a	a	a	a	a	a	a	a	a	a	a	a	101	101	103	103	103	103	103	103	101					
23	101	103	103	101	103	101	101	103	103	101	103	a	a	a	a	a	a	a	a	a	a	a	a	a	a	a					
24	a	a	a	a	a	a	a	a	a	a	a	a	a	a	a	111	111	111	113	115	116	120	118	116	116	116					
25	116	116	116	116	120	116	115	115	115	111	111	110	110	113	115	115	113	113	113	113	113	113	116	118	116	115	1238	3.40 a.m.	1086	10.20 a.m.	
26	115	113	113	115	113	111	110	110	113	111	110	110	a	a	a	a	a	a	a	a	a	a	a	a	a	a					
27	a	a	a	a	a	a	a	a	a	a	a	a	a	120	116	118	118	118	118	120	120	118	120	120	120	120					
28	120	120	118	120	118	120	120	120	118	118	118	118	118	116	118	118	120	118	120	120	120	120	120	120	120	121	1216	0.40 a.m.	1157	0.30 p.m.	
29	121	120	120	120	118	120	120	120	120	120	120	120	118	120	117	118	118	120	118	120	120	120	120	120	118	120	1216	0.20 ..	1172	2.10 ..	
30	120	120	118	120	120	118	118	118	118	118	118	116	120	120	121	121	121	121	121	120	121	120	121	121	120	120	1213	2.10 p.m.	1147	11.25 a.m.	
31	120	120	120	120	120	120	120	120	120	118	118	116	a	a	a	a	a	a	a	a	a	a	a	a	a	a					

VERTICAL FORCE, APRIL, 1902.

V = .7... C.G.S.

Day.	V = .7... C.G.S.																								Maximum reading and time.		Minimum reading and time.		
	Midt.	Forenoon.										Noon.	Afternoon.										Midt.						
		0.	1.	2.	3.	4.	5.	6.	7.	8.	9.		10.	11.	12.	1.	2.	3.	4.	5.	6.	7.		8.					9.
1	a	a	a	a	a	a	a	a	a	a	a	a	a	a	118	118	120	120	120	121	121	120	121	a'	118				
2	118	a'	a'	a'	a'	a'	a'	a'	a'	a'	a'	a'	a'	a'	a'	a'	115	115	115	115	116	116	115	116	a'				
3	a'	a'	a'	a'	a'	a'	a'	a'	113	115	111	111	113	110	110	110	113	113	113	115	115	115	116	116					
4	116	115	113	113	111	110	110	110	110	110	111	113	108	110	111	111	111	111	113	113	111	113	115	115	115	1161	0.10 a.m.	1081	0.10 p.m.
5	115	115	113	115	113	111	111	111	110	110	108	110	105	101	105	105	106	106	105	105	105	105	105	105	105	1152	0.50 ..	1007	0.40 ..
6	105	106	106	105	105	105	105	105	103	103	103	101	101	103	105	105	103	105	105	105	105	106	106	106	108	1090	12.0 p.m.	1007	10.50 a.m.
7	108	108	108	106	106	105	106	105	105	103	103	103	103	105	105	106	108	108	108	108	108	108	108	108	106	1081	1.40 a.m.	1030	9.23 ..
8	106	108	106	108	108	108	106	106	105	106	105	105	105	105	115	115	115	115	115	113	113	115	115	115	115	1163	9.30 p.m.	1048	Noon
9	115	116	115	115	115	113	113	113	113	115	111	113	111	113	111	111	113	115	115	116	118	118	118	118	116	1188	8.40 ..	1106	11.40 a.m.
10	116	115	113	115	115	113	113	111	111	113	113	113	113	a'	a'	a'	a'	a'	a'	a'	a'	a'	a'	a'	a'				
11	a'	a'	a'	a'	a'	a'	a'	a'	a'	a'	a'	a'	a'	a	a	a	a	128	126	131	136	136	138	143	136				
12	136	133	128	125	126	123	123	121	121	120	120	118	120	120	120	120	120	120	121	121	121	123	121	121	121	1362	0.0 a.m.	1172	10.40 a.m.
13	121	121	121	120	120	120	118	120	118	120	116	120	120	120	118	120	120	120	120	120	120	120	120	121	121	1222	1.40 ..	1159	10.20 ..
14	121	120	120	118	120	118	118	120	120	118	118	118	118	118	118	118	120	120	120	121	121	121	120	120	120	1230	0.10 ..	1149	11.26 ..
15	120	120	120	120	120	120	120	120	118	118	118	118	118	116	123	123	123	123	125	125	125	125	125	126	123	1264	10.30 p.m.	1163	1.5 p.m.
16	123	125	123	121	125	125	125	125	125	125	123	121	123	123	125	125	125	125	126	126	a	a	a	a	a				
17	a	a	a	a	a	a	a	a	a	a	a	a	a	a	141	141	143	143	143	143	143	144	144	143	144				
18	144	144	143	144	144	144	143	143	143	144	143	141	144	144	143	144	144	144	144	144	146	144	143	144	146	1460	11.0 p.m.	1404	10.55 a.m.
19	146	146	144	146	144	144	144	144	144	144	144	144	143	144	a'	a	a	144	144	146	146	146	146	148	146				
20	146	148	148	146	148	146	144	144	144	143	143	143	143	b	141	141	a'	a'	a'	a'	a'	a'	a'	a'	a'				
21	a'	a'	a'	a'	a'	141	139	136	139	139	141	139	143	144	143	143	146	151	154	149	146	148	148	148	148				
22	148	148	148	149	148	146	146	a'	a'	a'	a'	a'	a'	a'	a'	a'	a'	a'	a'	a'	a'	a'	a'	a'	a'				
23	a'	a'	a'	a'	a'	a'	a'	a'	a'	a'	a'	a'	a'	a'	a'	a'	a'	a'	a'	a'	a'	a'	a'	a'	a'				
24	a'	a'	a'	a'	a'	a'	a'	a'	a'	a'	a'	a'	a'	149	149	149	149	151	149	149	149	149	149	149	149				
25	149	149	149	149	149	149	149	151	149	a'	a'	a'	149	149	151	151	151	149	151	151	151	151	151	153	153				
26	153	151	151	151	151	151	151	151	151	151	151	151	149	148	148	149	149	149	149	149	149	149	149	149	151	1527	0.0 a.m.	1477	1.14 p.m.
27	151	149	149	148	148	148	a'	a'	a'	a'	a'	a'	a'	a'	a'	a'	a'	a'	a'	a'	a'	a'	a'	a'	a'				
28	a'	a'	a'	a'	149	148	148	146	146	144	144	146	144	b	a'	a'	a'	a'	a'	a'	a'	a'	a'	a'	a'				
29	a'	a'	a'	a'	a	a	a	a	a	a	a	a	a	a'	a'	a'	a'	a'	a'	a'	a'	a'	a'	a'	a'				
30	a'	a'	a'	a'	a'	a	a	a	a	a	a	a	a	a	a	a	a	a	a	a	a	a	a	a	a				

H 2

HOURLY VALUES.

VERTICAL FORCE, MAY, 1902.

V = '7... C.G.S.

Day.	V = '7... C.G.S.																							Maximum reading and time.		Minimum reading and time.				
	Midt.	Forenoon.											Noon.	Afternoon.														Midt.		
	0.	1.	2.	3.	4.	5.	6.	7.	8.	9.	10.	11.	12.	1.	2.	3.	4.	5.	6.	7.	8.	9.	10.	11.	12.					
1	a	a	a	a	a	a	a	a	a	a	a	a	a	a	a	a	a	a	a	a	187	187	187	186	182					
2	182	182	184	182	182	182	181	181	181	182	184	184	184	184	184	181	177	179	179	179	179	177	179	179	179	1842	1.0 p.m.	1775	4.0 p.m.	
3	179	179	179	179	179	177	179	177	177	176	174	177	176	181	184	184	184	184	184	185	184	184	184	184	184	1850	6.40 ..	1738	9.55 a.m.	
4	184	a'	a'	a'	a'	a'	a'	a'	a'	a'	a'	a'	a'	182	182	184	184	184	186	186	187	189	186	186	187					
5	187	187	186	186	186	186	186	184	182	182	184	182	182	177	177	177	179	179	177	177	177	177	177	177	177	1875	0.50 a.m.	1767	3.0 p.m.	
6	177	177	179	179	179	177	179	177	177	177	177	177	177	179	179	181	179	181	181	181	181	181	181	181	181	1822	8.40 p.m.	1769	11.5 a.m.	
7	181	181	181	179	181	179	179	179	179	179	179	179	179	177	177	177	177	177	181	179	179	181	181	181	181	1813	0.25 a.m.	1772	4.10 p.m.	
8	181	181	182	181	181	179	179	179	179	177	177	177	179	177	179	179	181	179	179	179	179	179	181	181	179	1828	0.30 ..	1772	1.0 ..	
9	179	179	179	179	177	179	176	181	179	181	179	179	177	179	184	186	181	184	184	184	184	182	182	181	186	1932	2.27 p.m.	1764	6.20 a.m.	
10	186	186	186	184	184	a'	a'	a'	a'	a'	a'	a'	a	a	179	181	181	181	181	181	181	182	182	182	182					
11	182	182	182	182	181	181	181	179	179	179	179	179	179	a	a	a	a	a	a	a	a	a	a	a	a					
12	a	a	a	a	a	a	a	a	a	a	a	a	a	181	181	181	181	181	182	181	181	181	182	182	181					
13	181	181	179	181	181	181	181	181	181	179	181	181	179	177	177	179	177	179	179	179	a	a	a	a	a					
14	a	a	a	a	a	a	a	a	a	a	a	a	a	a	a	a	a	a	a	a	a	a	a	a	a					
15	a	a	a	a	a	a	a	a	a	a	a	a	a	a	a	a	a	a	a	a	a	a	a	a	a					
16	a	a	a	a	a	a	a	a	a	a	a	a	a	a	a	a	a	a	a	a	a	a	a	a	a					
17	204	204	204	204	204	204	204	204	204	204	202	202	202	202	206	204	206	206	206	206	206	206	207	207	206	206	2066	10.15 p.m.	2021	10.6 a.m.
18	206	206	206	206	204	206	206	206	204	204	204	204	204	204	204	204	204	204	204	204	204	204	206	206	206	2059	11.24 ..	2031	4.0 p.m.	
19	206	204	204	204	204	204	204	204	204	202	202	204	204	206	206	206	204	206	206	206	206	206	206	206	206	2069	9.5 ..	2025	8.40 a.m.	
20	206	206	206	206	204	204	204	204	204	204	204	204	202	202	202	202	202	204	204	204	204	206	204	204	204	2073	1.35 a.m.	2021	1.20 p.m.	
21	204	204	204	206	206	204	202	204	204	204	204	204	204	204	204	204	204	204	204	202	202	202	202	204	202	2055	3.12 ..	2025	6.58 ..	
22	202	202	204	204	201	202	202	202	204	202	202	202	202	202	202	202	204	202	202	204	204	204	202	204	204	204	2046	2.25 ..	2003	4.15 a.m.
23	204	202	202	202	202	202	202	202	202	202	201	201	201	a'	a'	a'	a'	a'	a'	a'	a	a	a	a	a					
24	a	a	a	a	a	a	a	a	a	a	a	a	a	a	a	a	a	a'	a'	a'	a'	a'	a'	a'	a'					
25	a'	a'	a'	a'	a'	a'	a'	a'	a'	a'	a'	a'	a'	a'	a'	a'	a'	a'	a'	a'	a'	a'	a'	a'	a'					
26	a'	a'	a'	a'	a'	a'	a'	a'	a'	a'	a'	a'	a'	156	158	158	a'	a'	a'	a'	a'	a'	a'	a'	a'					
27	a'	a'	a'	158	158	158	158	156	156	156	156	156	166	166	166	168	168	168	168	169	169	168	168	168	169					
28	169	168	168	168	168	168	168	168	166	166	168	166	173	173	173	173	173	174	173	173	173	173	173	173	173	1736	5.15 p.m.	1660	8.0 a.m.	
29	173	173	171	173	173	173	173	173	173	173	169	173	173	171	173	173	173	173	173	173	171	173	173	173	173	1741	10.55 ..	1691	10.10 ..	
30	173	174	174	173	171	171	171	171	171	169	171	169	168	168	169	168	171	173	a'	a'	a'	a'	a'	a'	a'					
31	a'	a'	a'	a'	a'	a'	a'	a'	a'	a'	a'	166	164	166	164	a'	a'	a'	a'	a'	a'	166	166	164	166					

VERTICAL FORCE, JUNE, 1902.

Day.	V = '7... C.G.S.																								Maximum reading and time.		Minimum reading and time.			
	Midt.	Forenoon.											Noon.	Afternoon.															Midt.	
		0.	1.	2.	3.	4.	5.	6.	7.	8.	9.	10.		11.	12.	1.	2.	3.	4.	5.	6.	7.	8.	9.						10.
1	166	167	167	167	167	167	166	167	166	166	166	163	160	160	161	163	163	161	163	164	169	167	166	167	166	1686	7.57 p.m.	1593	11.40 a.m.	
2	166	166	164	163	163	164	163	163	161	161	163	160	160	161	161	163	161	161	164	160	161	161	161	160	161	1660	0.35 a.m.	1599	Noon.	
3	161	161	160	161	161	160	161	161	160	a'	a'	a'	167	167	169	169	169	169	170	170	169	169	169	169	169	1686	0.56 a.m.	1612	9.0 p.m.	
4	169	169	169	167	167	167	167	167	167	169	167	166	161	161	161	161	161	161	161	161	161	161	161	161	164	1656	4.54 p.m.	1598	9.32 a.m.	
5	161	161	163	161	161	161	160	160	160	160	160	161	163	164	164	166	166	166	166	164	164	164	164	166	164	1656	4.54 p.m.	1598	9.32 a.m.	
6	164	164	164	164	164	164	164	164	164	164	163	164	163	161	160	161	161	161	161	163	161	161	161	161	164	1648	10.5 a.m.	1587	11.57 p.m.	
7	160	160	161	163	163	163	161	160	161	160	160	160	160	158	158	157	157	157	158	160	158	160	157	160	157	1640	4.30 "	1561	2.55 "	
8	157	158	158	158	157	157	158	158	158	158	158	158	158	158	158	157	158	158	158	158	160	160	160	158	160	1612	7.15 p.m.	1567	4.55 a.m.	
9	160	160	160	158	158	158	158	158	158	158	158	158	157	157	158	158	158	158	158	158	157	157	158	158	1612	0.55 a.m.	1570	8.40 p.m.		
10	158	158	158	158	157	157	157	157	157	157	157	158	a	a	a	a	a	a	a	a	a	a	a	a	1612	0.55 a.m.	1570	8.40 p.m.		
11	a	a	a	a	a	a	a	a	a	a	a	a	a	a	a	a	a	a	a	a	a	a	a	a	1612	0.55 a.m.	1570	8.40 p.m.		
12	163	163	163	163	163	161	163	163	161	163	163	161	161	163	163	163	163	163	164	164	163	163	163	163	163	1689	7.10 p.m.	1603	8.0 a.m.	
13	163	163	163	163	163	161	161	161	163	163	161	161	163	164	166	166	166	166	164	166	166	166	167	166	167	1670	10.50 "	1608	6.25 "	
14	167	166	167	166	167	166	166	166	166	166	166	164	166	166	166	164	166	167	166	166	166	166	166	166	1671	2.6 a.m.	1632	10.55 "		
15	166	166	166	164	166	164	164	163	164	164	164	163	164	163	164	164	166	166	164	164	164	164+	166+	163	163	1671	2.6 a.m.	1632	10.55 "	
16	164	163	164	163	163	163	163	163	163	160	161	161	161	161	161	163	161	161	161	161	163	163	161	163	1698	0.45 a.m.	1603	9.20 a.m.		
17	161	161	163	161	161	160	161	161	161	161	160	160	158	160	158	158	160	160	160	160	160	160	160	160	158	1627	2.5 "	1579	3.3 p.m.	
18	158	160	160	160	160	158	158	158	158	158	158	158	158	157	158	158	157	157	158	158	158	160	158	158	1611	8.55 p.m.	1570	4.3 "		
19	160	158	157	157	157	157	157	158	158	157	157	155	157	157	157	158	158	157	158	158	a	a	a	a	1611	8.55 p.m.	1570	4.3 "		
20	a	a	a	a	a	a	a	a	a	a	a	155	153	154	154	15	154	154	155	155	155	154	154	154	154	154	154	154	154	154
21	154	154	154	154	153	153	153	153	153	154	153	154	155	155	157	157	155	155	155	155	155	155	155	155	155	1565	1.50 p.m.	1526	9.54 a.m.	
22	155	157	157	157	155	155	157	157	157	155	157	157	155	155	157	155	155	155	155	157	158	160	160	160	1606	9.30 "	1553	4.25 p.m.		
23	160	158	158	158	158	158	155	155	155	154	155	154	155	154	155	155	157	155	157	157	155	155	155	157	155	1595	0.15 a.m.	1541	9.35 a.m.	
24	155	155	155	155	155	155	155	155	155	154	154	154	155	155	155	155	155	155	155	155	155	155	157	158	1583	11.30 p.m.	1542	8.0 "		
25	157	158	157	155	155	155	155	154	154	154	154	155	155	155	155	155	155	155	155	155	155	155	155	155	1596	1.5 a.m.	1528	7.50 "		
26	155	157	157	157	155	157	157	155	155	157	155	157	154	154	155	158	157	157	157	157	160	160	160	158	158	1612	8.30 p.m.	1540	9.5 "	
27	157	158	157	158	157	157	155	155	155	157	157	157	157	157	157	157	157	158	158	157	158	157	160	160	1609	9.35 "	1553	6.2 "		
28	158	160	158	158	157	157	157	155	157	157	157	157	157	157	158	158	158	158	158	158	157	158	157	157	1599	1.10 a.m.	1555	7.5 "		
29	157	157	157	158	158	157	157	155	155	157	157	157	157	157	158	158	158	158	158	158	157	158	161	161	1641	11.10 p.m.	1542	8.38 "		
30	161	161	158	158	158	158	157	157	155	157	157	155	157	158	158	158	160	160	160	160	161	166	167	161	160	1716	9.32 "	1550	8.1 "	

HOURLY VALUES.



VERTICAL FORCE, JULY, 1902.

V = 7... C.G.S.

Day.	V = 7... C.G.S.																								Maximum reading and time.		Minimum reading and time.	
	Midt.	Forenoon.										Noon.	Afternoon.										Midt.					
		0.	1.	2.	3.	4.	5.	6.	7.	8.	9.		10.	11.	12.	1.	2.	3.	4.	5.	6.	7.		8.				
1	160	160	160	162	160	159	160	159	159	159	158	158	159	159	159	159	159	159	160	160	159	159	160	160	1619	3.50 a.m.	1577	10.50 a.m.
2	160	159	159	159	159	158	158	158	159	158	157	158	158	158	158	158	158	158	159	159	159	159	158	159	1601	2.30 "	1574	9.47 "
3	159	159	158	158	158	159	158	158	158	158	158	158	158	159	158	158	158	158	158	158	157	158	158	158	1595	0.45 "	1570	9.30 p.m.
4	158	158	159	158	158	158	158	158	158	158	158	158	158	158	158	158	159	160	159	159	159	160	160	1618	11.59 p.m.	1568	5.55 a.m.	
5	160	159	158	159	158	158	158	158	158	158	158	158	159	159	159	159	159	159	159	159	159	162	160	1619	9.45 "	1577	5.45 "	
6	160	160	159	159	159	159	159	159	159	159	159	159	159	160	160	160	159	159	159	159	160	160	160	1618	8.0 "	1585	8.20 "	
7	159	160	160	159	160	160	160	160	160	159	160	159	a	a	a	a	a	a	a	a	a	a	a					
8	a	a	a	a	a	a	a	a	a	a	a	a	a	a	a	a	a	162	163	163	164	163	163	162				
9	162	163	163	164	162	160	162	162	160	160	160	159	159	160	160	160	159	160	160	160	160	160	160	162	1694	2.48 a.m.	1592	11.5 a.m.
10	162	a'	a'	a'	a'	a'	a'	a'	a'	a'	a'	a'	a'	a'	a'	160	160	162	162	162	162	162	162	162				
11	162	162	162	162	162	162	162	160	160	160	160	160	159	160	160	160	160	162	162	162	160	160	162	1626	1.58 a.m.	1592	0.25 p.m.	
12	160	160	162	162	160	160	160	160	159	159	160	159	159	159	159	159	159	160	160	162	162	163	163	1645	9.40 p.m.	1582	9.15 a.m.	
13	163	162	164	162	160	159	159	159	159	159	159	159	160	160	160	159	160	162	162	162	160	160	159	1655	1.40 a.m.	1584	7.50 "	
14	160	160	a'	a'	a'	a'	a'	a'	a'	a'	a'	a'	a'	a'	a'	a'	a'	a'	a'	a'	a'	a'	a'					
15	a'	a'	a'	a'	a'	a'	a'	a'	a'	a'	a'	a'	a'	a'	a'	a'	a'	162	160	162	162	162	162	162				
16	162	162	160	160	160	160	160	160	160	159	159	159	160	160	160	160	163	163	163	163	162	160	160	1635	7.40 p.m.	1593	11.0 a.m.	
17	160	160	160	160	160	160	160	160	159	159	160	159	159	158	160	159	158	158	159	158	158	159	158	159	1616	3.5 a.m.	1570	8.15 p.m.
18	158	158	158	158	156	156	a'	a'	a'	a'	a'	a'	a'	a'	a'	a'	154	155	155	155	156	a'	a'					
19	a'	a'	a'	a'	a	a	a	a	a	a	a	a	a	a	a	a	a	a	a	a	a	a	a					
20	a	a	a	a	a	a	a	a	a	a	a	a	a	a	a	141	143	145	148	150	152	154	154	155				
21	155	156	155	156	156	156	156	156	156	155	155	155	156	156	156	156	156	155	155	155	156	155	156	1568	8.3 a.m.	1553	8.50 p.m.	
22	156	156	155	155	155	155	155	155	155	155	155	155	152	154	152	152	152	154	154	154	154	154	154	1561	0.55 "	1522	2.42 "	
23	154	155	154	154	154	154	154	154	155	154	152	154	155	155	155	155	155	156	156	156	156	156	155	1566	6.5 p.m.	1524	10.0 a.m.	
24	156	155	154	155	154	155	154	155	155	154	154	154	152	150	152	154	156	156	155	155	156	156	156	1570	4.28 "	1495	1.5 p.m.	
25	155	154	152	154	154	154	152	152	152	154	154	154	154	155	155	155	154	155	156	155	155	155	155	1578	5.45 "	1523	8.10 a.m.	
26	154	154	154	154	152	152	154	152	152	152	152	152	152	152	152	158	156	155	160	158	155	156	158	154	1662	5.1 "	1497	7.30 "
27	154	152	152	a'	a'	a'	a'	a'	a'	a'	a'	148	148	148	150	150	148	150	150	148	150	150	151	151				
28	150	151	151	151	150	150	150	151	151	150	150	148	148	147	148	148	148	148	148	148	148	148	148	1508	2.50 a.m.	1472	0.50 p.m.	
29	148	148	147	147	147	147	147	147	147	147	147	147	147	147	147	147	147	147	148	148	148	147	147	1489	6.25 p.m.	1461	7.5 a.m.	
30	148	147	147	148	147	147	147	147	147	148	148	147	147	146	147	147	148	148	148	148	148	147	148	1484	3.50 "	1460	1.10 p.m.	
31	148	148	147	147	148	147	147	147	147	147	147	148	148	148	148	150	150	151	150	150	150	151	151	1511	11.45 "	1465	5.45 a.m.	

VERTICAL FORCE, AUGUST, 1902.

Day.	V = 7... C.G.S.																								Maximum reading and time.		Minimum reading and time.		
	Midt.	Forenoon.											Noon.	Afternoon.															Midt.
		0.	1.	2.	3.	4.	5.	6.	7.	8.	9.	10.		11.	12.	1.	2.	3.	4.	5.	6.	7.	8.	9.					
1	151	150	149	148	148	148	145	145	145	148	149	149	149	150	150	150	150	152	153	152	152	152	149	149	149	1529	7.55 p.m.	1455	8.2 a.m.
2	149	149	148	149	149	148	148	149	148	149	150	150	150	154	155	154	155	155	155	155	154	154	153	153	1560	6.0 ..	1485	2.5 ..	
3	153	154	154	153	152	152	150	150	149	149	149	149	148	148	147	147	147	148	147	147	148	147	148	148	1556	1.55 a.m.	1468	2.10 p.m.	
4	148	148	148	148	148	149	149	149	149	149	149	149	147	148	147	147	145	145	147	147	147	147	145	145	144	1496	5.35 ..	1445	11.42 ..
5	144	143	144	144	144	144	144	144	144	145	144	144	143	144	144	145	145	147	147	147	147	145	147	147	1470	10.48 p.m.	1434	11.50 a.m.	
6	147	145	147	147	147	147	145	144	145	144	143	a'	a'	118	115	115	120	129	133	135	137	138	139	139	140				
7	140	140	142	142	142	142	142	142	142	142	142	143	143	140	140	140	138	137	135	a	a	a	a	a	a				
8	a	a	a	a	a	a	a	a	a	a	a	a	147	145	145	143	144	143	143	142	143	142	142	140					
9	140	140	140	140	140	139	140	140	140	140	142	138	139	139	140	140	140	142	140	140	142	142	142	143	144	1453	11.50 p.m.	1384	0.15 p.m.
10	144	144	143	143	142	142	139	140	140	140	142	139	137	138	137	138	137	137	137	135	135	135	134	135	135	1449	0.10 a.m.	1345	10.10 ..
11	135	134	134	134	134	133	133	133	130	132	130	130	137	138	138	139	140	139	139	140	139	139	140	139	139	1408	4.15 p.m.	1305	10.1 a.m.
12	139	139	139	139	138	138	138	138	138	139	139	142	148	148	149	149	154	154	153	152	150	152	150	149	149	1549	5.0 ..	1375	7.50 ..
13	149	148	148	147	147	147	145	144	144	144	144	142	140	139	140	140	140	140	140	139	139	138	138	138	1488	0.5 a.m.	1376	11.20 p.m.	
14	138	138	139	142	144	147	148	149	150	153+	152+	152+	152+	159	157	154	152	150	150	150	150	149	149	148	148				
15	148	147	147	145	145	145	144	143	143	143	142	142	140	140	140	140	139	139	139	139	139	139	138	138	1479	0.25 a.m.	1385	11.35 p.m.	
16	138	139	139	139	139	138	138	138	138	139	139	139	143	142	145	145	147	147	147	147	148	149	149	148	148	1501	10.28 p.m.	1381	5.20 a.m.
17	148	148	149	149	149	149	149	149	149	149	149	149	149	149	150	150	150	152	152	152	152	150	149	150	149	1516	6.45 ..	1480	0.32 ..
18	149	149	149	149	149	148	147	147	147	145	147	147	147	147	148	149	150	149	148	149	149	150	149	148	147	1504	9.5 ..	1453	9.10 ..
19	147	147	145	144	144	144	143	143	143	143	143	142	142	145	145	144	143	143	144	144	144	143	143	143	1475	0.10 a.m.	1416	11.40 ..	
20	143	143	143	142	143	142	143	143	143	142	142	142	145	145	145	144	143	143	144	145	145	145	145	146	144	1462	11.0 p.m.	1415	10.15 ..
21	144	144	144	a'	a'	a'	a'	a'	a'	a'	a'	a'	142	142	143	142	142	143	142	143	143	143	143	143	143				
22	143	143	144	144	144	143	143	143	143	142	142	142	144	145	145	149	147	147	147	147	145	150	147	145	145	1520	9.0 p.m.	1417	11.0 a.m.
23	145	144	144	144	143	143	143	143	144	144	144	144	142	142	142	144	144	144	144	145	144	143	144	144	1463	7.30 ..	1403	0.50 p.m.	
24	144	143	142	144	142	143	143	140	140	139	138	139	139	142	142	142	143	142	143	144	143	142	142	142	1454	6.57 ..	1378	9.25 a.m.	
25	142	142	142	142	140	139	140	138	139	138	139	138	139	139	140	140	142	142	143	143	143	143	143	143	1453	10.15 ..	1379	9.3 ..	
26	143	143	143	143	142	140	140	140	140	142	142	142	143	142	143	143	143	143	143	143	143	143	144	144	1445	11.45 ..	1388	8.15 ..	
27	144	145	145	145	145	145	144	144	144	144	143	144	143	143	143	144	145	144	144	145	145	147	148	147	147	1480	10.0 ..	1421	10.30 ..
28	147	145	145	145	145	145	145	145	145	144	144	142	140	140	140	142	140	142	142	142	142	142	142	142	1468	0.30 a.m.	1401	11.45 ..	
29	142	140	140	142	142	140	139	139	139	138	139	139	140	142	142	142	142	142	142	142	142	142	143	143	142	1431	11.25 p.m.	1380	9.35 ..
30	142	142	142	143	143	143	143	143	143	143	143	143	142	142	140	142	142	142	142	142	142	140	140	140	139	1435	8.30 a.m.	1395	11.50 p.m.
31	139	139	138	137	137	137	137	137	135	135	134	135	134	133	133	133	134	134	134	134	133	134	137	139	1409	9.25 p.m.	1331	1.10 ..	

HOURLY VALUES.

VERTICAL FORCE, SEPTEMBER, 1902.

Day.	V = '7... C.G.S.																									Maximum reading and time.		Minimum reading and time.	
	Midt.	Forenoon.											Noon.	Afternoon.											Midt.				
	0.	1.	2.	3.	4.	5.	6.	7.	8.	9.	10.	11.	12.	1.	2.	3.	4.	5.	6.	7.	8.	9.	10.	11.	12.				
1	141	141	141	140	140	140	140	138	138	138	138	141	143	142	142	141	140	141	143	143	142	142	140	140	140	1442	11.42 a.m.	1375	9.58 a.m.
2	140	140	140	140	140	140	140	140	140	140	140	142	141	141	142	142	143	142	142	143	146	144	144	144	146	1470	8.30 p.m.	1392	10.10 ,,
3	146	146	144	143	144	144	143	142	141	141	140	141	140	138	140	138	138	140	141	141	141	141	142	141	141	1459	1.5 a.m.	1384	2.45 p.m.
4	141	142	142	141	141	140	140	140	140	138	d	d	d	138	138	138	140	140	141	142	142	143	142	141	141	1419	9.40 p.m.	1371	7.18 a.m.
5	141	141	141	140	141	141	140	138	138	138	138	138	138	140	140	140	140	140	141	141	142	142	141	142	141	1419	9.40 p.m.	1371	7.18 a.m.
6	141	142	141	141	141	142	142	141	142	141	140	138	137	138	a'	a'	a'	a'	a'	a'	a'	a'	a'	a'	a'	137			
7	137	140	141	140	140	138	138	140	140	138	138	137	137	137	136	137	137	138	138	138	138	138	138	138	140	1409	1.35 a.m.	1365	0.50 p.m.
8	140	138	138	138	138	137	138	137	138	138	137	137	138	140	140	140	140	140	141	141	141	141	140	140	140	1409	7.0 p.m.	1370	10.20 a.m.
9	140	141	141	141	140	140	138	140	138	137	137	137	135	136	136	137	138	137	138	137	137	137	137	137	137	1406	3.10 a.m.	1352	0.20 p.m.
10	137	138	137	136	137	136	136	137	136	136	136	135	135	135	136	135	136	136	137	136	137	137	138	138	140	1398	11.40 p.m.	1346	10.20 a.m.
11	140	138	138	138	138	138	136	136	136	135	135	130	130	131	133	133	133	133	134	134	134	134	134	134	134	1395	0.2 a.m.	1303	11.2 ,,
12	134	133	134	134	134	134	131	131	130	129	129	128	129	130	130	131	131	131	131	131	133	131	131	131	131	1344	2.20 ,,	1285	11.45 ,,
13	131	131	135	133	131	131	130	131	131	131	131	d	d	d	d	d	d	d	d	d	d	d	d	d	d				

VERTICAL FORCE, OCTOBER, 1902.

V = '7... C.G.S.

Day.	V = '7... C.G.S.																								Maximum reading and time.		Minimum reading and time.		
	Midt.	Forenoon.											Noon.	Afternoon.															Midt.
		0.	1.	2.	3.	4.	5.	6.	7.	8.	9.	10.		11.	12.	1.	2.	3.	4.	5.	6.	7.	8.	9.					
1	d	d	d	d	d	d	d	d	d	d	d	d	d	d	d	d	d	d	d	d	d	d	d	d	d				
2	d	d	d	d	d	d	d	d	d	d	d	d	d	d	d	d	d	d	d	d	d	d	d	d	d				
3	d	d	d	d	d	d	d	d	d	d	d	d	d	d	275	274	a'	a'	a'	a'	a'	a'	a'	a'	a'				
4	a'	a'	a'	a'	a'	a'	a'	a'	a'	a'	a'	a'	258	259	259	259	259	259	260	260	260	260	261	261	262				
5	262	262	261	261	261	261	261	261	261	261	261	258	256	255	255	255	256	256	256	a'	a'	a'	a'	a'	a'				
6	a'	a'	a'	a'	a'	a'	a'	a'	a'	a'	a'	258	258	258	259	259	259	259	259	259	259	259	259	259	259				
7	259	259	258	259	258	258	258	258	258	258	258	258	259	260	260	260	261	261	261	261	261	261	261	261	260	2614	7.45 p.m.	2570	10.5 a.m.
8	260	260	260	260	259	259	259	259	260	259	259	259	259	259	259	259	260	260	261	261	261	261	261	261	261	2612	11.0 "	2581	9.40 "
9	261	261	261	260	261	260	260	260	259	258	259	259	260	260	260	261	262	262	262	262	262	262	263	263	263	2631	10.30 "	2583	9.25 "
10	263	263	262	262	262	262	261	261	260	260	260	260	260	260	260	260	260	261	260	260	261	261	261	260	260	2631	0.10 a.m.	2594	0.57 p.m.
11	260	260	260+	259+	258+	258+	258+	258+	258+	258+	258+	b	259+	261+	262	262	262	262	263	263	263	d	d	d	d				
12	264	263	264	263	262	261	262	262	262	260	260	259	259	259	260	261	262	262	263	263	262	263	263	263	2646	1.55 a.m.	2581	9.15 a.m.	
13	263	263	263	262	262	262	262	263	263	263	262	262	258	256	256	256	256	257	257	258	258	258	258	258	2638	9.0 "	2558	3.15 p.m.	
14	258	258	258	258	258	257	257	258	257	258	257	256	256	258	259	260	260	261	261	261	261	261	262	262	262	2619	11.50 p.m.	2560	10.55 a.m.
15	262	262	262	262	263	262	262	262	261	262	261	261	261	260	260	260	261	261	262	262	262	262	263	263	262	2637	10.20 "	2593	1.30 p.m.
16	262	262	262	261	261	261	261	260	260	259	258	257	258	256	256	259	263	264	264	264	265	265	265	265	265	2648	11.50 "	2551	1.18 "
17	265	265	265	265	265	265	265	265	264	264	263	b	250	248	249	249	249	250	252	253	255	256	257	258	258				
18	258	258	259	258	258	258	259	259	259	257	255	256	259	259	259	259	259	259	260	260	260	260	260	260	2602	11.30 p.m.	2532	10.25 a.m.	
19	260	260	260	260	260	260	260	260	260	260	259	256	253	253	253	253	254	255	255	256	256	256	257	256	2610	5.40 a.m.	2523	1.15 p.m.	
20	256	256	256	256	256	256	256	256	256	256	256	260	260	260	260	260	260	260	261	260	261	261	261	261	2608	9.25 p.m.	2555	5.0 a.m.	
21	261	261	261	261	261	261	261	260	260	261	261	262	262	262	262	262	262	262	263	263	262	263	263	263	2632	11.45 "	2591	9.50 "	
22	263	263	263	263	262	262	263	263	262	260	260	254	254	256	255	255	255	255	256	257	258	259	259	259	2647	7.10 a.m.	2535	11.55 "	
23	259	259	259	259	259	259	259	259	258	258	258	260	260	260	260	260	260	260	260	260	260	260	261	261	2610	11.50 p.m.	2578	8.25 "	
24	261	261	261	261	260	260	261	259	258	257	258	260	258	260	261	262	262	a'	a'	a'	a'	a'	a'	a'					
25	a'	a'	a'	a'	a'	a'	a'	a'	a'	a'	a'	257	258	259	259	260	261	262	262	262	263	263	264	265					
26	266	266	265	266	265	264	264	263	263	263	263	263	262	262	262	262	263	263	264	264	265	265	264	265	2664	0.25 a.m.	2615	0.12 p.m.	
27	265	265	265	265	265	266	265	263	262	262	263	264	264	262	262	263	264	265	265	266	266	266	267	268	2681	11.5 p.m.	2612	8.5 a.m.	
28	267	267	267	266	266	267	267	269	268	265	256	258	258	256	257	258	258	258	260	260	260	261	262	262	2701	7.2 a.m.	2546	10.25 "	
29	262	262	262	262	262	262	260	260	261	260	258	257	255	257	257	257	256	256	258	258	258	257	256	256	2634	2.58 "	2547	0.3 p.m.	
30	254	254	255	255	256	259	261	258	256	a	a	257	263	259	265	264	265	265	265	266	266	268	268	266					
31	266	265	265	265	264	263	263	263	265	265	264	262	260	d	d	d	d	d	d	d	d	d	d	d					

HOURLY VALUES.

VERTICAL FORCE, NOVEMBER, 1902.

V = .7... C.G.S.

Day.	V = .7... C.G.S.																								Maximum reading and time.		Minimum reading and time.		
	Forenoon.											Noon.	Afternoon.											Midt.					
	0.	1.	2.	3.	4.	5.	6.	7.	8.	9.	10.	11.	12.	1.	2.	3.	4.	5.	6.	7.	8.	9.	10.	11.					12.
1	270	270	270	269	268	267	267	266	264	262	259	254	253	255	256	257	257	258	258	258	259	260	260	260	260	2724	1.10 a.m.	2529	11.35 a.m.
2	260	260	260	259	259	259	260	260	259	261	266	264	262	260	260	260	259	259	263	d	d	d	d	d	d				
3	d	d	d	d	d	d	d	d	d	d	d	d	d	254	256	256	257	257	258	258	259	260	260	260	260	2627	7.28 p.m.	2574	0.3 p.m.
4	260	260	260	260	260	259	260	260	259	259	259	259	258	259	259	260	260	261	262	262	263	262	262	262	262	2627	7.28 p.m.	2574	0.3 p.m.
5	262	262	262	262	263	262	262	263	262	260	260	261	262	262	262	262	262	263	263	264	264	264	264	264	264	2644	11.30 ,,	2598	10.15 a.m.
6	264	265	264	265	265	265	264	264	264	263	263	263	263	263	264	264	265	265	265	265	265	266	265	266	266	2661	11.35 ,,	2616	9.25 ,,
7	266	266	266	266	265	264	265	266	265	266	266	266	266	266	266	265	264	265	266	266	266	267	267	266	266	2673	5.35 a.m.	2638	2.45 p.m.
8	266	266	266	265	264	265	265	266	267	266	265	264	261	261	261	262	264	265	265	265	265	265	265	264	264	2666	0.15 ,,	2599	11.58 a.m.
9	264	264	264	263	263	263	262	262	263	264	263	263	263	265	266	266	266	266	267	268	268	268	268	268	267	2681	9.3 p.m.	2620	7.10 ,,
10	267	267	267	268	266	266	265	266	265	265	265	265	266	266	266	266	267	268	268	269	269	269	270	270	269	2698	8.50 ,,	2642	10.45 ,,
11	269	268	268	268	268	268	268	267	267	265	266	266	b	b	271	272	273	272	272	272	272	272	271	271	271				
12	271	271	271	270	269	269	270	270	271	a	a	a	271	271	272	273	271	271	271	270	270	270	269	268	268				
13	268	268	269	268	268+	268+	267+	267+	266	264	262	a	a	a	a	a	a	234	234	234	235	235	235	236					
14	236	237	236	236	236	233	232	233	235	233	233	232	232	232	232	233	238	238	239	240	240	240	241	240	239	2414	11.30 p.m.	2311	0.50 p.m.
15	239	238	241	240	236	233	233	234	228	225	229	236	238	236	236	237	238	239	239	240	240	240	240	242	243	2425	11.30 ,,	2238	9.30 a.m.
16	d	d	d	d	d	d	d	d	d	d	d	d	d	a'	a'	a'	a'	a'	a'	a'	b	a'	a'	a'	244				
17	244	243	244	244	243	243	244	242	243	241	238	236	a	a	a	a	a	a	a	a	a	a	a	a	a				
18	a	a	a	a	a	a	a	a	a	a	a	a	a	230	231	232	233	234	235	235	235	235	235	234					
19	234	234	233	237	234	233	232	233	231	230	230	234	235	236	238	238	238	239	238	238	238	238	237	237	238	2389	5.3 p.m.	2270	8.45 a.m.
20	238	239	239	238	237	236	236	235	233	233	233	237	235	237	236	237	237	237	239	239	240	241	240	240	240	2421	9.12 ,,	2318	9.15 ,,
21	240	241	242	241	242	241	238	237	235	237	236	236	236	235	236	238	239	241	241	242	242	242	243	244	245	2457	11.40 ,,	2347	1.15 p.m.
22	245	245	244	243	245	246	246	237	243	241	240	239	240	237	237	238	239	240	240	239	240	239	239	240	240	2480	5.55 a.m.	2338	6.48 a.m.
23	240	242	241	241	245	239	240	242	245	244	241	240	236	235	237	239	240	241	242	242	244	244	245	244	243	2486	10.28 p.m.	2332	1.10 p.m.
24	243	242	240	239	236	231	228	225	221	220	233	227	227	229	232	232	234	234	234	235	235	238	238	239	2446	3.25 a.m.	2143	8.48 a.m.	
25	239	238	238	239	236	238	239	237	238	237	235	241	236	235	234	234	235	237	a'	a'	a'	a'	a'	a'	a'				
26	a'	a'	a'	a'	a'	a'	a'	a'	a'	a'	a'	a'	a'	a'	241	242	242	243	245	245	245	245	246	246	247				
27	247	247	249	249	249	247	247	248	250	247	246	244	243	242	243	243	244	244	246	244	244	244	243	d	d				
28	d	d	d	d	d	d	d	d	d	245	244	239	239	239	239	239	239	237	239	240	240	241	241	240	240				
29	240	240	238	239	239	238	237	235	235	236	236	237	237	236	236	236	237	237	a'	a'	a'	a'	a'	a'	a'				
30	a'	a'	a'	a'	a'	a'	a'	a'	a'	a'	239	235	236	241	240	239	240	241	242	241	241	242	242	243					

VERTICAL FORCE, DECEMBER, 1902.

Day.	V = .7... C.G.S.																								Maximum reading and time.		Minimum reading and time.		
	Midt.	Forenoon.											Noon.	Afternoon.															Midt.
		0.	1.	2.	3.	4.	5.	6.	7.	8.	9.	10.		11.	12.	1.	2.	3.	4.	5.	6.	7.	8.	9.					
1	243	244	241	240	242	243	241	240	238	237	235	233	232	235	237	237	238	239	240	241	242	243	244	245	245	2454	0.55 a.m.	2320	0.25 p.m.
2	245	248	247	248	245	a'	a'	a'	a'	a'	a'	239	238	237	238	238	238	238	240	241	243	245	244	245	2477	10.15 p.m.	2352	5.58 a.m.	
3	245	243	242	245	244	242	238	238	239	239	240	239	238	241	243	245	245	245	246	245	244	245	247	245	246	2474	9.20 ..	2379	7.35 ..
4	246	244	246	244	242	242	244	244	243	244	242	244	244	245	246	245	245	245	246	247	247	247	247	247	247	2474	9.20 ..	2379	7.35 ..
5	247	247	247	247	247	247	245	244	246	241	244	246	244	243	242	240	240	240	240	240	240	241	241	241	241	2500	4.18 a.m.	2388	9.25 ..
6	241	241	241	240	238	237	240	241	243	238	234	235	238	240	241	242	243	242	242	243	243	244	244	244	244	2452	8.40 ..	2322	9.55 ..
7	244	245	244	244	244	243	243	245	245	243	242	243	245	245	245	244	245	245	245	246	246	247	248	248	248	2484	9.58 p.m.	2413	8.40 ..
8	248	247	247	246	245	245	246	246	245	241	241	241	242	243	244	245	246	247	247	248	249	249	250	250	249	2507	10.5 ..	2372	9.30 ..
9	249	250	250	250	249	249	250	250	249	246	250	247	246	246	247	249	250	251	251	251	251	251	251	250	251	2519	8.5 ..	2459	9.28 ..
10	251	251	252	254	251	254	249	251	247	252	250	245	239	236	236	237	239	240	239	241	242	244	244	244	246	2580	4.45 a.m.	2347	1.13 p.m.
11	246	245	244	242	242	241	243	239	240	240	241	239	239	240	238	239	239	239	239	239	239	239	238	238	238	2472	0.15 ..	2378	10.45 ..
12	238	a'	a'	a'	a'	a'	a'	a'	a'	a'	a'	232	232	232	232	234	235	235	236	236	236	236	236	a'	a'				
13	a'	a'	a'	a'	a'	a'	a'	a'	a'	a'	a'	236	235	231	231	231	233	234	234	236	236	238	236	238	236				
14	236	237	237	235	235	234	235	231	229	232	230	229	234	236	239	241	241	242	241	241	242	242	241	241	241	2424	3.28 p.m.	2261	8.20 a.m.
15	241	240	240	239	239	237	238	238	237	239	238	233	235	238	237	239	239	241	240	240	239	239	240	241	241	2416	11.0 ..	2321	10.45 ..
16	241	240	242	241	240	241	241	241	243	244	242	237	234	236	a'	a'	a'	a'	a'	a'	245	244	245	245	244				
17	244	243	242	244	245	245	241	241	240	238	237	236	238	238	237	239	240	241	242	243	243	243	243	243	243	2476	4.55 a.m.	2348	10.40 a.m.
18	243	243	243	244	244	244	244	246	a'	a'	242	241	a'	241	241	240	240	241	241	241	241	d	d	d	d				
19	d	d	d	d	d	d	d	d	d	d	d	d	233	231	230	229	a'	a'	a'	a'	a'	a'	a'	a'	a'				
20	a'	a'	a'	a'	a'	a'	a'	a'	a'	234	235	233	235	238	239	239	240	241	240	240	240	241	241	241	242	a'			
21	a'	a'	a'	a'	a'	a'	a'	a'	a'	a'	a'	236	237	238	240	242	243	243	243	243	243	241	242	242	243	242			
22	242	240	240	241	240	239	240	242	243	244	246	244	237	241	244	243	244	244	244	245	245	244	243	245	244	2489	10.5 a.m.	2355	0.3 p.m.
23	244	245	246	242	238	241	241	240	242	241	245	245	245	241	a'	a'	a'	a'	a'	a'	a'	249	248	247	246				
24	246	246	249	248	244	244	242	246	246	247	247	244	245	244	245	243	245	245	245	244	245	245	247	246	247	2516	2.15 a.m.	2401	7.45 a.m.
25	247	246	248	247	245	245	248	247	247	245	242	239	240	242	242	242	242	243	244	246	246	246	246	247	245	2491	2.15 ..	2370	10.42 ..
26	245	243	244	245	245	246	247	246	243	242	235	237	234	237	239	240	241	242	244	246	247	245	a'	a'	a'				
27	a'	a'	a'	a'	a'	a'	a'	a'	a'	a'	244	244	245	246	243	241	244	248	249	249	249	249	249	247	a'	a'			
28	a'	a'	a'	a'	a'	a'	a'	a'	a'	a'	a'	244	248	247	250	251	250	251	250	249	d	d	d	d	d				
29	d	d	d	d	d	d	d	d	d	d	d	223	b	b	242	244	245	246	247	248	248	247	246	244	a'				
30	a'	a'	a'	a'	a'	a'	a'	a'	a'	243	245	244	235	236	235	235	237	239	241	242	a'	a'	a'	a'	a'				
31	a'	a'	a'	a'	a'	a'	a'	a'	a'	a'	a'	a'	232	234	234	234	234	238	241	245	243	239	238	238	238				

I 2

HOURLY VALUES.

VERTICAL FORCE, JANUARY, 1903.

V = .7... C.G.S.

Day.	V = .7... C.G.S.																								Maximum reading and time.		Minimum reading and time.			
	Midt.	Forenoon.											Noon.	Afternoon.															Midt.	
		0.	1.	2.	3.	4.	5.	6.	7.	8.	9.	10.		11.	12.	1.	2.	3.	4.	5.	6.	7.	8.	9.						10.
1	218	218	218	217	214	213	216	222	226	225	218	207	210	215	216	218	221	222	223	220	218	219	221	220	218	2318	8.0 a.m.	2059	11.0 a.m.	
2	218	219	218	218	218	219	223	228	228	218	222	201	186	185	a'	a'	a'	a'	194	195	195	194	193	193	a'					
3	a'	a'	a'	a'	a'	a'	a'	189	189	189	190	189	187	185	184	186	185	188	189	190	189	a'	a'	a'	a'					
4	a'	a'	a'	a'	a'	a'	a'	a'	189	187	187	202	203	203	203	202	204	209	213	217	218	213	212	213	212					
5	212	a'	a'	a'	a'	a'	a'	206	213	213	203	208	214	208	213	218	a'	a'	a'	a'	226	227	226	224	225					
6	225	223	229	228	229	220	218	221	221	218	213	217	218	218	218	219	220	219	218	219	219	216	218	218	218	2326	4.15 a.m.	2063	9.45 a.m.	
7	218	220	220	223	225	225	225	222	221	222	224	a'	a'	a'	a'	223	221	223	224	225	225	225	222	228	228					
8	228	228	228	229	228	229	227	226	226	224	223	221	219	218	218	218	218	221	224	226	223	222	218	218	217	2306	2.10 a.m.	2165	11.55 p.m.	
9	217	a'	a'	a'	a'	a'	a'	a'	217	218	214	214	213	212	211	212	212	213	213	a'	a'	a'	a'	a'	a'					
10	a'	a'	a'	a'	a'	a'	a'	a'	222	209	204	209	214	213	212	215	219	221	221	a'	a'	a'	a'	a'	223					
11	223	220	223	227	223	219	224	229	225	228	216	232	243	243	242	240	238	237	235	234	235	237	237	237	236	2521	11.50 a.m.	2127	9.45 a.m.	
12	236	237	234	231	235	240	236	226	240	238	244	224	218	215	218	221	218	219	218	218	219	219	220	223	223	2548	8.0 ..	2133	1.15 ..	
13	223	223	222	222	223	223	220	224	226	220	214	215	208	209	212	213	213	214	217	218	216	215	215	214	215	2282	7.55 ..	2069	0.40 p.m.	
14	215	214	216	215	218	222	223	219	220	216	208	209	206	206	208	206	207	209	209	209	209	209	210	212	213	2270	5.50 ..	2045	11.45 a.m.	
15	213	214	213	213	213	212	212	214	214	209	204	209	199	199	196	196	198	200	203	202	201	200	202	203	202	2152	1.10 ..	1950	1.20 p.m.	
16	202	203	204	208	205	206	204	204	204	202	201	199	198	196	198	201	201	201	201	200	202	204	205	206	208	2086	3.10 ..	1949	1.15 ..	
17	208	210	210	208	a	a	a	a	a	a	a	a	204	205	201	201	201	a	a	a	a	a	a	a	a					
18	a	a	a	a	a	a	a	a	a	a	a	a	a	a	a	a	a	a	a	a	a	a	a	a	a					
19	a	a	a	a	a	a	a	a	a	a	a	a	a	a	a	a	a	a	a	a'	a'	a'	a'	a'	a'					
20	a'	a'	a'	a'	a'	a'	a'	a'	a'	a'	a'	a'	a'	a'	a'	a'	a'	a'	a'	a'	a'	a'	a'	a'	a'					
21	a'	a'	a'	a'	a'	a'	a'	a'	a'	a'	a'	b	233	233	233	234	233	235	236	236	236	237	238	237	237					
22	237	239	241	239	239	238	239	238	237	236	235	235	235	237	237	237	236	236	238	238	238	240	240	242	243	2443	11.5 p.m.	2349	Noon	
23	243	243	243	a'	a'	a'	242	243	240	239	238	b	241	239	238	237	238	239	239	241	243	244	248	a'	a'					
24	a'	a'	a'	a'	a'	a'	a'	a'	250	248	242	242	242	242	243	242	243	243	243	243	245	a'	a'	a'	a'					
25	a'	a'	a'	a'	a'	a'	a'	a'	a	a	a	a	a	a	a	a	a	a	a	a	a	a	a	a	a					
26	a	a	a	a	a	a	a	a	a	a	a	a	a	a	a	a	a	a	a	a	a	a	a	a	a					
27	a	a	a	a	a	a	a	a	a	a	a	a	a	234	233	232	233	233	234	235	237	238	240	241	244					
28	244	241	a'	a'	a'	a'	a'	a'	243	242	241	a	a	a	a	a	a	a	a	247	246	245	245	246	247	248				
29	248	a'	a'	a'	a'	a'	a'	a'	a'	a'	a'	d	d	d	d	d	d	d	d	d	d	d	d	d	d					
30	d	d	d	d	d	d	d	d	d	d	d	d	244	245	243	248	a'	a'	a'	a'	a'	a'	a'	a'	a'					
31	a'	a'	a'	a'	a'	a'	a'	a'	252	252	248	246	243	241	241	241	243	242	d	d	d	d	d	d	d					

VERTICAL FORCE, FEBRUARY, 1903.

Day.	V = 7... C.G.S.																								Maximum reading and time.		Minimum reading and time.			
	Midt.	Forenoon.											Noon.	Afternoon.															Midt.	
	0.	1.	2.	3.	4.	5.	6.	7.	8.	9.	10.	11.	12.	1.	2.	3.	4.	5.	6.	7.	8.	9.	10.	11.					12.	
1	d	d	d	d	d	d	d	d	d	d	d	d	d	d	d	d	d	d	d	d	d	d	d	d	d					
2	d	d	d	d	d	d	d	d	d	d	d	240	239	238	237	237	239	242	245	246	245	244	243	241	242					
3	242	242	243	244	242	243	243	243	242	240	238	a	a	a	a	a	a	249	250	251	250	250	251	251						
4	251	252	250	248	249	248	248	251	254	255	253	a'	a'	253	254	256	257	d	d	d	d	d	d	d						
5	d	d	d	d	d	d	d	d	d	d	d	d	d	d	d	d	d	d	d	d	d	d	d	d						
6	d	d	d	d	d	d	d	d	d	d	d	d	d	d	d	d	263	264	265	265	266	266	266	267	268					
7	268	268	269	270	270	270	267	266	265	265	264	264	264	265	264	264	263	263	265	266	266	264	264	264	265	2716	4.25 a.m.	2624	10.57 a.m. also 4.0 p.m.	
8	265	266	265	266	265	262	263	265	262	262	261	260	259	257	256	258	d	d	d	d	d	d	d	d						
9	d	d	d	d	d	d	d	d	d	d	d	d	d	d	d	d	d	258	258	258	259	258	a'	a'	a'					
10	a'	a'	a'	a'	a'	a'	a'	a'	a'	a'	a'	a'	a'	266	267	264	265	265	a'	a'	a'	a'	a'	a'						
11	a'	a'	a'	a'	a'	a'	a'	a'	a'	a'	a'	a'	a'	a'	a'	a'	a'	a'	a'	a'	a'	a'	a'	a'						
12	a'	a'	a'	a'	a'	a'	a'	a'	a'	a'	a'	a'	251	248	249	249	249	250	250	251	253	255	254	253	254	255				
13	255	255	a'	a'	a'	a'	a'	a'	a'	258	a	a	a	258	261	262	262	263	267	268	268	267	267	a'	a'					
14	a'	a'	a'	a'	a'	a'	a'	a'	a'	a	264	264	265	262	262	261	262	264	264	264	264	264	264	266	266					
15	266	266	267	266	266	267	268	265	266	266	266	a'	265	262	261	262	263	264	265	265	266	a'	a'	a'						
16	a'	a'	a'	a'	267	268	265	266	266	268	267	266	263	262	261	261	262	264	264	265	263	264	265	265	a'					
17	a'	a'	a'	a'	a'	a'	a'	a'	a'	a'	a'	265	264	263	263	263	264	265	265	265	266	266	266	267	267					
18	267	267	268	270	270	269	268	268	266	267	264	d	d	d	d	d	d	d	d	d	d	d	d	d						
19	d	d	d	d	d	d	d	d	d	d	d	d	261	260	261	261	261	261	260	259	258	258	257	257	256					
20	256	257	256	256	256	256	255	255	256	257	258	263	a'	a'	a'	a'	264	264	264	264	264	264	265	265	265					
21	265	264	263	262	261	261	262	263	267	267	266	264	264	263	262	263	265	a	a	a	270	271	272	272	272					
22	272	273	273	272	272	269	269	270	270	271	271	269	267	266	266	266	267	268	268	269	272	271	271	270	270	2750	1.45 a.m.	2652	1.52 p.m.	
23	270	269	267	266	265	264	266	269	270	271	269	266	271	a'	a'	a'	a'	a'	a'	a'	a'	a'	a'	a'						
24	a'	a'	a'	a'	a'	a'	a'	a'	a'	a'	a'	a'	a'	a'	a'	a'	a'	a'	266	266	267	268	268	269	269					
25	269	268	269	269	a'	a'	270	268	268	268	267	266	266	266	264	265	265	267	268	270	271	272	272	273	273					
26	273	272	271	270	270	269	268	269	269	270	269	267	266	264	265	266	266	265	265	265	266	266	267	267	267	2730	0.0 a.m.	2629	0.55 p.m.	
27	267	267	268	268	a'	a'	a'	269	266	264	263	262	260	260	263	265	266	266	a'	a'	a'	a'	a'	a'						
28	a'	a'	a'	a'	a'	a'	a'	268	268	268	268	268	268	267	267	267	267	268	266	265	264	265	266	a'						

HOURLY VALUES.



VERTICAL FORCE, MARCH, 1903.

V = 7... C.G.S.

Day.	V = 7... C.G.S.																								Maximum reading and time.		Minimum reading and time.		
	Midt.	Forenoon.											Noon.	Afternoon.															Midt.
	0.	1.	2.	3.	4.	5.	6.	7.	8.	9.	10.	11.	12.	1.	2.	3.	4.	5.	6.	7.	8.	9.	10.	11.	12.				
1	a'	a'	a'	a'	250	245	243	240	235	230	226	220	a'	a'	a'	a'	a'	a'	a'	a'	217	226	233	236	239				
2	239	240	242	242	242	242	245	246	246	243	239	237	236	237	237	237	239	240	240	240	243	245	245	249	250	2504	12.0 p.m.	2350	11.57 a.m.
3	250	a'	a'	a'	239	235	232	230	226	225	224	221	220	220	221	223	223	224	220	220	220	221	220	220	220				
4	220	220	220	220	220	220	220	219	219	218	216	213	219	a'	a'	a'	a'	a'	a'	a'	231	237	243	246	246				
5	246	245	245	245	245	245	245	245	243	242	239	230	a'	a'	a'	a'	a'	a'	a'	228	234	240	245	253	259				
6	259	265	a'	a'	a'	259	253	249	250	245	245	243	241	241	242	241	242	242	240	240	240	240	239	239	239				
7	239	240	239	238	238	238	238	236	233	227	225	220	225	228	230	232	234	235	236	240	241	242	242	243	243	2429	11.50 p.m.	2197	11.15 a.m.
8	243	242	240	240	240	241	240	240	238	239	240	233	234	233	232	232	236	238	239	239	239	238	240	239	240	2437	0.40 a.m.	2319	2.45 p.m.
9	240	239	239	239	238	236	235	235	235	234	234	231	234	234	234	234	237	240	240	240	240	241	240	240	241	2412	9.5 p.m.	2309	10.40 a.m.
10	241	240	241	241	240	239	240	240	239	236	236	235	233	232	234	235	235	236	236	236	237	238	238	237	238	2417	2.25 a.m.	2318	0.50 p.m.
11	238	238	238	238	237	235	235	234	234	232	232	231	231	231	231	232	229	228	230	230	231	231	232	232	232	2387	1.25 "	2280	4.40 "
12	232	232	231	231	230	230	230	229	229	228	229	228	227	226	227	227	240	240	240	240	242	244	245	246	246	2465	11.35 p.m.	2256	1.20 "
13	246	246	246	245	245	245	247	245	243	248	245	243	245	242	242	241	241	244	247	249	248	252	252	254	254	2535	11.45 "	2407	3.5 "
14	254	254	253	252	253	254	253	253	253	254	250	249	246	247	247	245	243	242	245	246	249	249	251	250	249	2570	0.55 a.m.	2413	4.40 "
15	249	249	249	249	248	247	249	249	249	249	248	246	245	244	244	244	242	243	244	244	245	246	245	245	246	2505	0.2 "	2423	3.55 "
16	246	247	246	249	248	246	245	245	245	245	244	244	241	241	240	242	249	249	251	251	252	253	251	251	250	2537	8.58 p.m.	2404	1.30 "
17	250	250	250	250	249	249	249	248	248	247	246	246	246	245	245	245	245	247	247	247	248	247	247	247	248	2512	0.0 a.m.	2446	2.20 "
18	248	248	247	247	247	246	247	246	246	247	249	246	245	245	245	245	245	d	d	d	d	d	d	d	d				
19	d	d	d	d	d	d	d	d	d	d	d	d	d	d	d	d	d	d	d	d	d	d	d	d	d				
20	d	d	d	d	d	d	d	d	d	d	d	d	d	d	d	d	d	252	254	256	258	259	259	259	257				
21	257	256	255	254	254	254	254	254	254	254	252	253	254	252	249	249	251	254	255	256	256	257	255	255	256	2575	0.50 a.m.	2486	2.5 p.m.
22	256	256	256	255	254	254	254	254	254	252	251	250	250	251	250	252	251	251	252	251	251	252	252	252	251	2563	0.2 "	2495	11.50 a.m.
23	251	252	252	251	253	253	254	256	255	254	254	a	a	249	248	249	249	d	d	d	d	d	d	d					
24	d	d	d	d	d	d	d	d	d	d	d	d	d	d	d	d	d	d	d	d	d	d	d	d	d				
25	d	d	d	d	d	d	d	d	d	d	d	d	d	d	d	d	256	256	257	257	258	258	257	257	257				
26	257	257	257	257	257	257	256	256	257	256	256	255	255	255	255	255	254	252	254	254	254	254	254	254	254	2571	8.20 a.m.	2525	5.10 p.m.
27	254	254	254	254	254	254	254	254	254	254	253	252	252	252	252	252	252	252	251	252	251	251	251	251	251	2549	1.35 "	2512	11.15 "
28	251	252	251	251	251	251	252	251	250	249	249	249	249	249	250	250	249	249	249	249	249	249	249	248	248	2520	0.50 "	2495	4.30 "
29	252	252	251	251	250	251	250	250	251	251	251	248	249	250	249	250	250	246	247	249	249	249	249	248	248	2524	1.15 "	2463	5.30 "
30	248	249	249	249	250	250	250	249	249	248	248	248	247	249	249	249	249	246	247	248	249	249	249	249	249	2510	4.20 "	2463	5.25 "
31	249	248	247	247	247	247	249	249	249	249	246	244	243	243	243	244	243	242	243	245	245	245	245	245	245	2520	8.35 "	2414	5.2 "

VERTICAL FORCE, APRIL, 1903.

V = 7... C.G.S.

Day.	Forenoon.																								Afternoon.												Maximum reading and time.		Minimum reading and time.	
	Midt.												Noon.												Midt.															
	0.	1.	2.	3.	4.	5.	6.	7.	8.	9.	10.	11.	12.	1.	2.	3.	4.	5.	6.	7.	8.	9.	10.	11.	12.															
1	245	244	245	245	245	244	244	242	241	241	239	241	239	239	241	241	242	242	242	242	242	244	244	244	2484	3.40 a.m.	2342	9.10 a.m.												
2	244	244	244	244	242	242	242	242	241	239	236	237	237	239	241	239	239	239	239	239	241	242	242	241	241	2450	0.30 "	2361	11.35 "											
3	241	241	241	241	241	239	237	237	236	236	239	236	236	236	236	236	236	236	236	237	237	237	237	239	2418	1.50 "	2350	9.10 "												
4	239	239	239	239	237	237	237	237	237	237	237	237	236	237	237	237	239	241	241	241	241	241	241	241	2418	0.20 "	2358	11.50 "												
5	241	239	239	239	239	237	237	237	237	237	237	237	237	237	237	237	242	244	245	247	247	247	245	245	2484	8.50 p.m.	2358	1.25 p.m.												
6	245	247	247	250	250	245	245	244	245	245	247	247	244	244	244	244	245	244	245	245	247	249	d	d	d															
7	d	d	d	249	247	245	247	247	249	249	250	249	245	245	242	244	244	245	247	249	247	247	249	249	249															
8	249	249	252	250	249	249	249	244	244	244	247	249	245	244	244	245	245	245	245	247	247	247	247	247	2536	2.3 a.m.	2409	9.20 a.m.												
9	247	245	247	247	247	247	245	247	245	244	244	242	244	242	245	247	245	247	249	250	249	249	247	247	245	2517	6.15 p.m.	2403	11.10 "											
10	245	247	244	244	245	244	245	245	247	242	242	244	242	241	242	242	242	242	d	d	d	d	d	d																
11	d	d	d	d	d	d	d	d	d	d	d	d	d	d	d	d	244	244	245	245	245	245	245	247	247															
12	247	245	244	244	242	242	242	242	242	242	244	241	241	241	241	241	237	237	237	239	237	239	239	239	237	2468	0.10 a.m.	2368	4.50 p.m.											
13	237	239	239	239	237	239	237	237	237	237	236	236	233	236	236	236	239	241	241	241	242	242	242	242	241	2437	9.50 p.m.	2332	0.20 "											
14	241	239	239	239	237	237	237	237	239	241	239	237	236	236	237	237	d	d	d	d	d	d	d	d																
15	d	d	d	d	d	d	d	d	d	d	d	d	d	d	d	d	234	234	236	237	236	237	242	242	244															
16	244	242	242	242	242	237	236	234	236	234	236	236	241	239	241	d	d	d	d	d	d	d	d	d																
17	d	d	d	d	d	d	d	d	d	d	d	d	d	d	d	d	d	d	d	d	d	d	d	d																
18	d	d	d	d	d	d	d	d	d	d	d	d	d	d	d	d	239	239	239	239	239	239	237	239	242	245														
19	245	244	239	239	239	241	242	244	244	245	245	245	244	242	242	244	d	d	d	d	d	d	d	d																
20	d	d	d	d	d	d	d	d	d	d	d	d	d	d	d	d	d	d	d	d	d	d	d	d																
21	d	d	d	d	d	d	d	d	d	d	d	d	d	d	d	239	239	241	241	241	241	242	244	242	241	241														
22	241	241	241	241	241	241	239	239	239	239	239	237	239	239	239	239	239	239	239	239	239	239	239	239	237	2421	2.30 a.m.	2374	10.25 a.m.											
23	237	237	237	237	237	237	237	237	237	237	237	236	236	236	234	234	234	234	234	236	236	236	234	234	234	2398	4.50 "	2335	2.20 p.m.											
24	234	236	236	234	234	234	233	233	233	233	233	231	231	234	234	a	a	a	a	a	a	a	a	a	a															
25	a	a	a	a	a	a	a	a	a	a	a	a	a	a	a	231	231	231	231	231	231	233	233	234	234															
26	234	234	233	231	231	231	231	231	231	231	231	231	231	231	231	231	233	233	231	231	231	231	231	231	231	2379	0.20 a.m.	2295	7.35 a.m.											
27	231	231	231	231	231	231	229	229	231	231	231	231	229	229	d	d	d	d	d	d	d	d	d	d																
28	d	d	d	d	d	d	d	d	d	d	d	d	d	d	d	d	d	d	d	d	d	d	d	d																
29	d	d	d	d	d	d	d	d	d	d	d	d	d	d	d	224	226	228	228	228	228	226	228	226	226	226	224													
30	224	226	226	226	226	224	223	224	224	224	224	224	226	226	226	228	228	228	228	228	228	228	228	228	228	2285	11.58 p.m.	2224	10.10 a.m.											

HOURLY VALUES.

VERTICAL FORCE, MAY, 1903.

Day.	V = 7... C.G.S.																								Maximum reading and time.		Minimum reading and time.			
	Midt.	Forenoon.										Noon.	Afternoon.										Midt.							
		0.	1.	2.	3.	4.	5.	6.	7.	8.	9.		10.	11.	12.	1.	2.	3.	4.	5.	6.	7.		8.					9.	10.
1	229	230	230	230	230	229	229	230	230	229	229	229	229	229	229	229	229	229	229	229	229	229	229	230	2315	2.25 a.m.	2285	0.30 p.m.		
2	230	229	227	227	227	227	227	227	226	226	226	226	227	226	225	225	226	226	226	226	226	226	226	226	2300	{ 0.35 "	2246	{ 2.0 "		
3	226	226	226	226	226	226	226	227	227	227	227	227	227	227	226	224	224	224	224	224	224	224	224	222	{ 0.55 "	2227	{ 2.10 "			
4	222	222	222	222	222	222	224	224	224	224	224	224	224	224	222	222	222	221	222	222	222	222	222	222	2248	9.15 "	2211	12.0 "		
5	222	224	224	224	222	222	224	224	222	221	221	221	216	217	216	216	221	221	221	221	221	221	221	221	2246	10.5 "	2154	4.25 "		
6	221	221	219	219	219	219	221	221	221	219	219	217	219	219	219	221	221	222	224	226	224	224	226	232	229	2344	6.3 "	2161	0.5 "	
7	229	227	226	224	222	222	222	222	222	222	221	222	221	221	222	222	222	222	222	222	224	224	224	226	226	226	2305	11.3 p.m.	2193	10.30 a.m.
8	226	226	224	224	222	222	222	221	222	222	222	221	221	214	213	214	214	214	214	214	214	214	214	214	213	2272	0.0 a.m.	2183	0.20 p.m.	
9	213	214	214	213	214	214	214	213	213	213	213	213	213	211	211	213	213	213	213	213	213	213	213	211	211	213	2156	0.10 "	2107	12.0 "
10	213	213	213	213	213	211	211	211	211	211	213	211	211	213	213	213	213	214	216	216	214	214	213	213	2161	5.55 "	2106	9.55 "		
11	213	213	214	214	214	214	213	213	213	213	211	211	213	213	216	216	216	216	216	216	217	217	217	216	2172	6.20 p.m.	2110	8.15 a.m.		
12	216	216	216	214	214	214	214	214	214	213	213	213	213	213	213	213	213	213	213	213	213	213	213	213	2161	9.25 "	2110	10.10 "		
13	213	213	211	213	213	213	213	213	213	213	213	213	a	a	a	a	a	a	a	a	a	a	a	a	2161	1.50 a.m.	2115	11.50 p.m.		
14	a	a	a	a	a	a	a	a	a	a	a	a	a	a	a	a	a	a	a	a	a	a	a	a	a	a	a	a	a	a
15	a	a	a	a	a	a	a	a	a	a	a	a	a	a	a	a	a	a	a	a	a	a	a	a	a	a	a	a	a	a
16	a	a	a	a	a	a	a	a	a	a	a	a	a	a	a	a	a	a	a	a	a	a	a	a	a	a	a	a	a	a
17	a	a	a	a	a	a	a	a	a	a	a	a	a	a	a	a	a	a	a	a	a	a	a	a	a	a	a	a	a	a
18	a	a	a	a	a	a	a	a	a	a	a	a	a	a	226	226	226	226	227	227	227	227	227	227	227	227	227	227	227	227
19	227	226	227	227	227	227	227	227	227	227	227	227	227	224	226	226	226	227	226	227	227	227	227	227	2277	7.40 p.m.	2242	0.15 p.m.		
20	227	227	227	227	227	227	227	227	227	227	227	227	227	224	224	224	224	224	224	224	224	226	226	226	2279	7.15 a.m.	2245	0.50 "		
21	226	226	224	224	224	224	224	224	226	226	226	224	222	221	222	222	222	222	222	222	222	222	224	224	2255	9.20 "	2209	0.30 "		
22	222	222	224	222	222	222	222	221	a	a	a	a	a	222	222	222	222	222	222	222	222	222	224	224	222	222	222	222	222	222
23	222	222	222	224	224	224	224	222	222	222	224	a	a	a	a	a	a	a	a	a	a	a	a	a	a	a	a	a	a	a
24	a	a	a	a	a	a	a	a	a	a	a	a	a	a	229	230	230	232	232	232	232	232	232	a	a	a	a	a	a	a
25	a	a	a	a	a	a	a	a	a	a	a	a	a	a	221	221	222	222	222	222	222	222	224	224	a	a	a	a	a	a
26	a	a	a	a	a	a	a	a	a	a	a	a	a	a	219	221	221	222	222	222	222	221	a	a	a	a	a	a	a	a
27	a	a	a	a	a	a	a	a	a	a	a	a	a	a	221	a	a	a	a	a	a	a	a	a	a	a	a	a	a	a
28	a	a	a	a	a	a	a	a	a	a	a	a	a	a	219	219	219	219	219	221	222	c	c	221	221	221	221	221	221	221
29	221	219	219	219	219	217	217	217	217	216	216	a	a	a	209	211	211	211	211	211	211	211	213	214	214	213	213	213	213	213
30	213	213	211	211	209	209	209	209	209	209	208	208	208	208	208	206	206	206	206	206	209	209	208	209	209	2130	0.35 a.m.	2062	2.3 p.m.	
31	209	208	208	206	206	206	206	205	205	205	205	205	205	205	205	205	205	205	205	206	206	206	208	206	2096	0.50 "	2039	9.10 a.m.		

VERTICAL FORCE, JUNE, 1903.

Day.	V = '7... C.G.S.																								Maximum reading and time.		Minimum reading and time.		
	Midt.	Forenoon.											Noon.	Afternoon.															Midt.
	0.	1.	2.	3.	4.	5.	6.	7.	8.	9.	10.	11.	12.	1.	2.	3.	4.	5.	6.	7.	8.	9.	10.	11.	12.				
1	206	206	206	206	206	206	206	206	206	204	206	206	206	206	206	204	204	204	204	206	206	208	209	209	2104	11.25 p.m.	2045	3.45 p.m.	
2	209	211	211	209	209	209	211	209	208	206	208	206	206	206	206	208	212	217	214	212	211	211	211	211	2251	5.25 "	2042	10.55 a.m.	
3	211	211	212	209	208	208	208	206	206	206	208	206	206	208	208	209	206	206	208	206	206	206	206	204	2165	2.5 a.m.	2037	10.5 p.m.	
4	204	206	206	206	206	203	203	203	203	203	203	203	203	203	204	204	208	209	206	204	204	206	206	206	2146	4.15 p.m.	2023	7.50 a.m.	
5	206	204	201	203	203	204	203	203	203	203	203	203	204	204	204	204	206	206	206	206	208	206	206	204	2078	9.13 "	2010	1.50 "	
6	204	204	204	206	208	206	206	204	204	204	204	204	203	203	201	201	201	201	201	201	201	201	201	201	2078	3.30 a.m.	2013	4.20 p.m.	
7	201	201	201	201	201	201	201	199	199	199	199	199	201	203	203	203	203	204	204	204	204	204	203	203	2062	6.45 p.m.	1995	8.20 a.m.	
8	203	203	203	203	203	203	203	204	204	204	204	204	203	201	199	199	199	201	201	201	a	a	a	a					
9	a	a	a	a	a	a	a	a	a	a	a	a	a	a	203	203	203	203	203	201	203	201	201	203					
10	203	203	204	203	203	201	201	201	201	201	201	201	203	203	201	203	201	203	203	203	203	203	203	204	2047	11.35 p.m.	1995	5.45 a.m.	
11	204	203	203	203	203	203	203	203	203	203	203	203	203	203	201	201	199	201	201	201	201	201	201	201	2044	1.50 a.m.	1995	2.45 p.m.	
12	201	201	201	201	201	201	201	201	203	203	203	203	203	202	201	201	201	199	201	201	201	201	201	201	2034	8.40 "	1995	4.40 "	
13	201	201	201	201	201	201	201	201	201	199	201	201	201	199	199	199	199	199	201	201	201	201	201	201	2019	0.35 "	1995	2.50 "	
14	201	201	201	201	201	199	199	199	199	199	199	199	199	199	198	198	198	198	199	199	199	198	198	199	2016	2.45 "	1982	2.40 "	
15	199	199	199	199	198	199	199	199	199	199	198	199	199	199	d	d	d	d	d	d	d	d	d	d					
16	d	d	d	d	d	d	d	d	d	d	d	d	d	d	196	196	196	196	196	196	196	196	196	198					
17	198	198	196	196	196	198	198	196	196	196	195	195	195	196	199	199	199	199	201	201	201	199	199	201	2016	6.50 p.m.	1943	9.50 a.m.	
18	201	201	199	199	199	a	a	a	a	a	a	a	a	a	199	199	199	199	198	199	199	201	201	199					
19	198	198	198	198	199	199	198	198	198	198	198	198	196	196	196	198	199	199	199	198	199	198	198	196	2024	3.40 p.m.	1960	11.55 p.m.	
20	196	196	196	195	196	195	195	195	195	195	195	195	195	d	d	d	d	d	d	d	d	d	d	d					
21	d	d	d	d	d	d	d	d	d	d	d	d	d	d	198	198	198	198	198	198	198	198	198	198					
22	198	198	201	198	196	196	196	196	196	195	195	195	196	196	196	195	196	196	198	203	199	198	196	195	2039	6.55 p.m.	1942	9.40 a.m.	
23	196	196	196	195	196	196	195	195	d	d	d	d	d	d	d	d	d	d	d	d	d	d	d	d					
24	d	d	d	d	d	d	d	d	d	d	d	d	d	d	d	d	d	d	d	d	d	d	d	d					
25	d	d	d	d	d	d	d	d	d	d	d	d	d	d	198	198	198	199	199	199	201	199	198	198					
26	198	199	199	199	199	198	198	198	198	198	198	198	198	196	196	195	196	196	196	196	198	196	196	196	2007	1.45 a.m.	1953	3.5 p.m.	
27	196	196	196	195	195	196	195	196	196	195	195	196	196	196	196	196	196	198	199	199	199	198	198	199	1995	5.0 p.m.	1947	9.50 a.m.	
28	199	199	199	198	198	198	198	198	198	198	198	196	196	196	195	196	196	198	198	198	203	204	201	199	2143	8.30 "	1953	2.5 p.m.	
29	199	198	198	198	198	199	199	198	198	198	198	198	198	195	199	201	201	203	203	203	203	206	204	203	204	2081	9.0 "	1950	1.10 "
30	204	208	211	208	208	209	208	206	206	204	203	204	203	203	203	204	203	203	203	203	203	204	204	206	2130	1.40 a.m.	2000	10.0 a.m.	

K

HOURLY VALUES.

VERTICAL FORCE, JULY, 1903.

Day.	V = '7... C.G.S.																								Maximum reading and time.		Minimum reading and time.		
	Midt.	Forenoon.											Noon.	Afternoon.															Midt.
	0.	1.	2.	3.	4.	5.	6.	7.	8.	9.	10.	11.	12.	1.	2.	3.	4.	5.	6.	7.	8.	9.	10.	11.					12.
1	208	208	208	205	205	205	205	205	205	203	205	203	203	d	d	d	d	200	200	205	206	205	203	203	203				
2	203	203	201	203	203	201	201	201	201	201	200	200	200	200	200	200	200	200	200	200	201	201	200	200	200	2059	1.5 a.m.	1989	0.35 p.m.
3	200	200	200	200	200	200	198	200	198	200	198	198	198	200	200	201	201	201	201	201	200	200	200	200	2031	2.45 p.m.	1961	8.45 a.m.	
4	200	198	198	197	200	198	198	198	198	197	197	197	197	198	200	198	200	201	201	200	200	201	201	201	2033	10.15 "	1961	9.20 "	
5	200	200	200	200	198	198	198	198	198	197	197	197	197	197	198	198	198	200	200	200	198	198	198	198	2012	0.0 a.m.	1963	10.2 "	
6	198	198	198	198	198	198	197	195	195	195	197	197	197	198	197	198	200	198	198	200	206	208	201	201	200	2128	8.40 p.m.	1934	8.10 "
7	200	198	198	198	197	197	198	197	197	197	197	197	197	197	198	198	198	198	200	200	200	198	198	198	198	2016	6.40 "	1958	4.40 "
8	198	197	197	197	198	198	198	198	197	197	197	197	197	198	198	198	198	198	198	198	198	198	198	197	1994	1.35 "	1966	3.5 "	
9	197	197	198	197	198	198	197	197	197	197	197	197	197	200	198	200	201	201	201	201	203	203	201	201	2042	9.35 "	1961	8.45 "	
10	201	201	201	201	203	201	200	200	198	200	200	200	200	200	200	201	201	203	201	201	201	203	205	203	201	2075	10.15 "	1982	8.40 "
11	201	201	203	203	203	203	203	203	201	201	201	200	200	200	200	201	201	203	201	203	205	203	203	201	2068	8.40 "	1994	10.55 "	
12	201	200	201	201	203	201	200	200	200	200	200	200	200	200	198	197	198	198	198	198	198	198	198	197	2049	3.50 a.m.	1969	3.10 p.m.	
13	197	197	197	197	197	197	197	198	198	198	198	198	198	198	201	200	200	200	200	200	203	205	201	200	2060	8.35 p.m.	1963	3.40 a.m.	
14	200	200	198	198	200	200	200	198	200	200	197	198	198	198	198	198	198	198	198	200	200	200	200	200	2012	0.45 a.m.	1966	10.25 "	
15	200	200	200	200	200	200	200	198	198	198	198	197	198	198	198	198	200	200	200	200	200	201	201	201	2028	10.0 p.m.	1969	11.10 "	
16	201	201	200	198	198	a	a	a	a	a	a	a	a	a	a	a	a	a	a	a	a	a	a	a					
17	a	a	a	a	a	a	a	a	a	a	a	a	a	a	203	205	205	203	205	203	203	203	203	203					
18	203	201	203	203	203	201	201	200	200	200	200	201	201	201	205	205	206	208	208	208	206	205	205	205	205	2130	6.0 p.m.	1994	8.50 a.m.
19	205	206	206	205	206	205	203	203	203	201	201	203	203	200	200	200	210	206	205	205	213	208	208	208	2242	4.10 "	1984	1.35 p.m.	
20	208	206	208	206	206	208	205	203	201	203	203	201	201	200	195	195	195	197	197	198	197	197	198	198	2094	4.30 a.m.	1945	2.30 "	
21	198	197	195	195	193	193	193	193	193	193	193	193	193	193	193	192	195	197	195	195	195	195	193	193	2012	4.15 p.m.	1921	2.35 "	
22	193	192	192	192	193	193	193	193	193	193	192	193	193	193	193	193	193	193	193	193	193	192	192	192	193	1948	5.35 "	1921	9.10 "
23	193	193	193	190	190	190	190	190	190	190	190	190	192	190	185	185	187	187	187	187	188	188	188	188	1932	0.10 a.m.	1855	2.40 "	
24	188	188	188	188	188	188	187	187	187	187	187	187	187	d	d	d	d	d	d	d	d	d	d	d					
25	d	d	d	d	d	d	d	d	d	d	d	d	d	d	d	d	d	d	d	d	d	d	d	d					
26	d	d	d	d	d	d	d	d	d	d	d	d	d	d	d	195	198	198	205	205	201	201	206	208	208				
27	208	216	208	203	203	201	201	200	200	198	200	203	201	201	200	198	198	200	203	205	203	201	208	208	208	2234	0.35 a.m.	1981	4.20 p.m.
28	208	206	201	203	208	205	201	200	200	198	200	198	197	198	197	200	200	201	200	205	203	206	201	201	203	2117	3.37 "	1952	0.18 "
29	203	201	200	198	198	200	200	198	197	197	197	197	195	195	198	198	198	201	200	200	200	198	198	197	197	2050	0.5 "	1939	11.42 a.m.
30	197	197	197	197	197	197	195	195	195	193	193	193	193	195	193	195	195	195	195	195	195	195	195	195	195	1984	3.20 "	1927	11.40 "
31	195	195	195	195	195	195	195	193	193	195	195	195	195	193	195	195	195	195	197	198	200	200	203	203	200	2052	9.15 p.m.	1927	7.40 "

VERTICAL FORCE, AUGUST, 1903.

V = .7... C.G.S.

Day.	V = .7... C.G.S.																								Maximum reading and time.		Minimum reading and time.			
	Midt.	Forenoon.											Noon.	Afternoon.															Midt.	
	0.	1.	2.	3.	4.	5.	6.	7.	8.	9.	10.	11.	12.	1.	2.	3.	4.	5.	6.	7.	8.	9.	10.	11.	12.					
1	198	a'	a'	a'	a'	a'	a	a	a	a	a	a	a	a	197	198	198	198	198	200	198	197	197	198	193					
2	198	200	201	200	198	198	197	198	198	198	197	195	195	195	a	a	a	a	a	a	a	a	a	a	a					
3	a	a	a	a	a	a	a	a	a	a	a	a	a	a	187	187	189	187	187	187	187	187	187	189	189					
4	189	189	190	190	189	189	189	189	187	187	187	187	187	187	187	189	190	190	190	190	190	190	190	192	190	1917	11.20 p.m.	1866	11.30 a.m.	
5	190	190	190	192	192	190	190	190	189	187	187	187	185	185	185	187	187	187	187	187	187	187	187	185	185	1923	3.55 a.m.	1837	2.0 p.m.	
6	185	187	187	187	187	187	187	187	185	185	185	185	185	185	185	184	184	184	184	185	185	185	185	187	1870	2.15 ..	1839	2.40 ..		
7	187	187	187	185	185	184	184	184	184	184	182	182	184	184	182	180	180	180	180	180	182	182	182	182	1879	0.15 ..	1805	2.55 ..		
8	182	182	182	180	180	180	182	182	182	182	182	180	179	179	179	179	179	179	179	180	180	180	180	180	1831	1.20 ..	1782	0.35 ..		
9	180	182	182	180	179	177	177	179	179	177	179	179	179	179	179	179	180	180	180	180	180	180	179	179	1834	2.10 ..	1768	8.30 a.m.		
10	179	179	180	184	180	177	177	179	177	177	177	176	176	179	179	179	179	179	179	180	179	179	a	a	a					
11	a	a	a	a	a	a	a	a	a	a	a	a	a	176	185	180	177	177	177	180	180	185	190	185	184					
12	184	184	182	184	180	180	180	180	180	179	179	180	180	180	182	184	184	185	184	185	185	a	a	a	a					
13	a	a	a	a	a	a	a	a	a	a	a	a	a	a	177	182	179	179	179	179	179	179	180	184	184					
14	184	179	179	179	179	177	177	177	177	177	177	177	177	177	177	177	180	180	180	180	187	189	185	180	184	1902	8.50 p.m.	1753	6.30 a.m.	
15	184	189	185	182	179	177	177	177	177	179	177	177	177	177	180	182	185	184	182	180	182	182	180	180	1973	1.22 a.m.	1746	6.45 ..		
16	180	180	180	180	179	179	179	179	179	179	179	177	179	179	180	180	180	180	180	180	179	179	179	180	1818	4.50 p.m.	1772	10.40 ..		
17	179	180	182	182	180	180	179	179	179	179	179	179	177	177	177	176	177	177	179	179	180	180	179	180	1834	2.55 a.m.	1754	9.30 ..		
18	180	180	179	179	179	179	179	179	179	179	179	179	177	179	177	177	177	177	180	179	180	179	179	179	1821	0.5 ..	1771	2.50 p.m.		
19	179	179	179	179	179	177	177	177	177	177	177	177	177	177	177	177	179	179	179	179	179	179	179	179	1811	2.30 ..	1763	11.45 a.m.		
20	179	179	179	179	177	179	179	177	177	177	177	177	177	177	179	179	177	179	179	180	180	180	179	179	1810	7.15 p.m.	1763	0.55 p.m.		
21	179	179	180	180	179	177	177	176	176	176	174	172	169	171	171	171	172	172	174	74	176	177	177	176	1823	3.15 a.m.	1687	0.35 ..		
22	176	174	174	174	176	174	174	174	172	172	172	172	171	172	176	176	179	189	182	182	187	190	189	187	185	1936	4.45 p.m.	1687	8.25 a.m.	
23	185	189	187	182	179	179	179	179	179	179	179	179	180	176	174	172	174	174	174	176	177	d	d	d	d					
24	d	d	d	d	d	d	d	d	177	174	174	176	176	177	177	180	177	179	180	180	179	179	180	180						
25	180	180	182	179	179	179	177	177	177	977	177	177	176	174	172	174	174	176	177	176	176	176	176	179	177	1844	2.5 a.m.	1714	2.0 p.m.	
26	177	177	177	179	176	177	176	176	176	176	174	176	177	176	d	d	d	d	d	d	d	d	d	d	d					
27	d	d	d	d	d	d	d	d	d	d	d	d	d	d	d	d	d	d	d	d	d	d	d	d	d					
28	d	d	d	d	d	d	d	d	d	d	d	d	d	d	d	d	172	172	172	174	174	174	177	176	174					
29	174	174	174	174	174	172	174	174	174	172	172	171	171	d	d	d	d	d	d	d	d	d	d	d	d					
30	d	d	d	d	d	d	d	d	d	d	d	d	d	d	d	166	167	167	167	167	167	167	169	169	171	171				
31	171	172	171	169	169	169	169	167	167	169	167	167	167	167	167	167	169	169	171	171	171	171	171	172	172	1740	1.10 a.m.	1648	10.30 a.m.	

K 2

HODRLY VALUES.

VERTICAL FORCE, SEPTEMBER, 1903.

Day.	V = 7... C.G.S.																								Maximum reading and time.		Minimum reading and time.		
	Midt.	Forenoon.											Noon.	Afternoon.															Midt.
	0.	1.	2.	3.	4.	5.	6.	7.	8.	9.	10.	11.	12.	1.	2.	3.	4.	5.	6.	7.	8.	9.	10.	11.	12.				
1	172	172	174	174	174	174	174	172	170	170	170	170	170	170	170	170	170	172	172	172	172	172	172	170	1735	7.5 a.m.	1702	1.35 p.m.	
2	170	170	170	170	170	172	172	170	170	170	170	170	170	167	165	165	165	165	165	165	165	165	167	169	1727	4.50 "	1647	2.50 "	
3	169	170	167	167	169	169	167	165	167	167	164	164	164	165	165	165	165	165	165	165	165	165	165	165	1700	0.30 "	1634	10.40 a.m.	
4	165	165	165	165	165	165	165	165	165	165	165	165	164	164	165	165	167	169	169	169	169	170	172	170	169	1719	9.25 p.m.	1637	0.3 p.m.
5	169	169	167	167	167	165	165	165	165	165	165	165	165	164	165	165	165	165	165	165	165	167	167	169	169	1693	0.15 a.m.	1638	7.30 a.m.
6	169	169	169	169	169	169	165	165	165	165	162	162	164	161	164	164	164	165	170	169	165	165	165	164	1737	6.55 p.m.	1608	10.50 "	
7	164	164	164	164	164	165	165	164	164	164	164	164	164	161	161	161	162	162	162	162	162	162	162	162	1651	6.20 a.m.	1608	2.30 p.m.	
8	162	162	162	162	162	162	162	162	161	159	157	157	157	159	159	161	162	162	162	162	162	162	164	164	164	1646	11.55 p.m.	1556	10.35 a.m.
9	164	162	162	162	162	162	162	161	164	164	164	162	161	164	164	164	165	167	170	172	169	169	169	167	1719	6.45 "	1606	0.20 p.m.	
10	167	167	165	164	164	164	164	165	164	162	164	162	164	164	164	165	a	a	a	a	a	a	a	a					
11	a	a	a	a	a	a	a	a	a	a	a	a	a	a	a	a	a	a	a	a	a	a	a	a					
12	a	a	a	a	a	a	a	a	a	a	a	a	a	a	a	a	a	a	a	a	a	a	a	a					
13	a	a	a	a	a	a	a	a	a	a	a	a	a	a	a	a	a	a	a	a	a	a	a	a					
14	a	a	a	a	a	a	a	a	a	a	a	a	a	a	a	a	a	a	a	a	a	a	a	a					
15	a	a	a	a	a	a	a	a	a	a	a	a	a	a	a	a	a	a	a	a	a	a	a	a					
16	a	a	a	a	a	a	a	a	a	a	a	a	a	a	a	a	a	a	a	a	a	a	a	a					
17	a	a	a	a	a	a	a	a	a	a	a	a	a	a	a	a	a	a	a	a	a	a	a	a					
18	a	a	a	a	a	a	a	a	a	a	a	a	a	a	a	a	a	a	a	a	a	a	a	a					
19	a	a	a	a	a	a	a	a	a	a	a	a	a	a	a	a	a	a	a	a	a	a	a	a					
20	a	a	a	a	a	a	a	a	a	a	a	a	a	a	a	a	172	172	172	174	174	175	174	180	183				
21	183	180	177	175	174	174	172	174	172	170	172	174	172	169	169	170	170	169	170	170	170	170	170	172	1833	0.0 a.m.	1672	9.30 a.m.	
22	172	174	172	172	172	170	170	169	170	172	167	170	169	167	167	169	169	169	169	169	169	170	170	170	172	1739	0.55 "	1661	10.25 "
23	172	172	172	172	170	170	170	170	170	167	167	169	169	167	165	167	165	167	169	170	172	172	172	172	172	1732	1.25 "	1640	9.15 "
24	172	172	172	172	170	169	169	170	169	174	170	164	167	167	167	169	167	169	167	169	169	169	169	169	169	1755	9.10 "	1640	11.25 "
25	169	165	165	165	164	162	162	161	161	161	161	161	162	162	162	162	164	a	a	a	a	a	a	a					
26	a	a	a	a	a	a	a	a	a	a	a	a	a	a	a	a	a	a	a	a	a	a	a	a					
27	a	a	a	a	a	a	a	a	a	a	a	a	a	a	a	a	a	a	a	a	a	a	a	a					
28	a	a	a	a	a	a	a	a	a	a	a	a	a	a	a	a	a	a	a	a	a	a	a	a					
29	a	a	a	a	a	a	a	a	a	a	a	a	a	a	162	162	162	164	167	167	169	169	169	172	174				
30	174	174	170	169	169	167	165	165	165	167	164	162	161	159	159	161	162	162	165	164	164	164	164	164	1737	0.40 a.m.	1591	1.20 p.m.	

HOURLY VALUES.

VERTICAL FORCE, OCTOBER, 1903.

V = 7... C.G.S.

Day.	Midt.	Forenoon.											Noon.	Afternoon.											Midt.	Maximum reading and time.		Minimum reading and time.	
		0.	1.	2.	3.	4.	5.	6.	7.	8.	9.	10.		11.	12.	1.	2.	3.	4.	5.	6.	7.	8.	9.		10.	11.	12.	
1	164	164	166	166	166	167	167	167	167	167	166	167	167	166	169	169	169	169	171	171	171	171	171	171	171	1717	11.18 p.m.	1645	0.25 a.m.
2	171	172	171	169	169	169	167	167	167	166	166	166	166	169	171	171	172	172	171	171	d	d	d	d	175				
3	175	174	174	174	172	174	172	174	175	175	172	172	172	172	172	172	a	a	a	a	a	a	a	a	a				
4	a	a	a	a	a	a	a	a	a	a	a	a	a	a	a	a	a	a	a	a	a	a	a	a	a				
5	a	a	a	a	a	a	a	a	a	a	a	a	a	a	a	a	a	a	a	a	a	a	a	a	a				
6	a	a	a	a	a	a	a	a	a	a	a	a	a	a	a	a	a	164	166	167	174	169	167	167	166				
7	166	166	164	166	162	159	159	161	162	169	167	169	171	169	169	169	171	177	175	177	180	179	177	177	177	1811	7.40 p.m.	1566	6.15 a.m.
8	177	177	175	174	174	172	172	174	174	174	175	169	172	174	174	172	177	a	a	a	a	a	a	a	a				
9	a	a	a	a	a	a	a	a	a	a	a	a	a	a	a	a	a	a	a	a	a	a	a	a	a				
10	a	a	a	a	a	a	a	a	a	a	a	a	a	a	a	a	a	a	a	a	a	a	a	a	a				
11	a	a	a	a	a	a	a	a	a	a	a	a	a	a	a	a	a	a	a	a	a	a	a	a	a				
12	a	a	a	a	a	a	a	a	a	a	a	a	a	a	a	a	a	a	177	179	177	177	182	188	183				
13	183	180	180	172	177	177	172	177	174	174	174	174	174	177	172	177	177	180	a	a	a	a	a	a	a				
14	a	a	a	a	a	a	a	a	a	a	a	a	a	a	a	a	a	a	a	a	a	a	a	a	a				
15	a	a	a	a	a	a	a	a	a	a	a	a	a	a	a	a	a	174	174	175	175	174	174	174	175				
16	175	177	177	177	172	174	174	175	175	174	175	174	172	171	172	172	174	174	172	172	172	172	172	172	172	1803	2.20 a.m.	1701	1.30 p.m.
17	172	174	174	172	172	174	177	177	175	177	172	171	167	169	169	169	169	169	167	169	171	171	174	174	172	1783	6.40 "	1660	0.5 "
18	172	172	174	172	172	172	171	172	171	174	174	174	171	167	169	169	171	a	a	a	a	a	a	a	a				
19	a	a	a	a	a	a	a	a	a	a	a	a	a	a	a	a	a	a	a	a	a	a	a	a	a				
20	a	a	a	a	a	a	a	a	a	a	a	a	a	a	a	a	a	a	a	a	a	a	a	a	a				
21	a	a	a	a	a	a	a	a	a	a	a	a	a	a	a	a	a	a	a	a	a	a	a	a	a				
22	a	a	a	a	a	a	a	a	a	a	a	a	a	a	a	a	a	a	a	a	a	a	a	a	a				
23	a	a	a	a	a	a	a	a	a	a	a	a	a	a	a	a	a	a	a	a	a	a	a	a	a				
24	a	a	a	a	a	a	a	a	a	a	a	a	a	a	a	a	a	a	a	a	a	a	a	a	a				
25	a	a	a	a	a	a	a	a	a	a	a	a	a	a	a	a	a	a	a	a	a	a	a	a	a				
26	a	a	a	a	a	a	a	a	a	a	a	a	a	a	a	a	a	166	166	166	167	169	171	169	169				
27	169	171	171	172	171	172	169	167	166	167	166	166	162	162	161	162	162	164	162	166	167	167	169	167	167	1740	5.0 a.m.	1602	2.50 p.m.
28	167	167	167	167	167	167	166	166	166	166	166	164	164	162	162	161	162	a	a	a	a	a	a	a	a				
29	a	a	a	a	a	a	a	a	a	a	a	a	a	a	a	a	a	a	a	a	a	a	a	a	a				
30	a	a	a	a	a	a	a	a	a	a	a	a	a	a	a	a	a	a	a	a	a	a	a	a	a				
31	a	a	a	a	a	a	a	a	a	a	a	a	a	a	a	a	a	a	a	a	a	a	a	a	a				

HOURLY VALUES.



VERTICAL FORCE, NOVEMBER AND DECEMBER, 1903, AND JANUARY, 1904.

NOVEMBER, 1903.

V = .7... C.G.S.

Day.	Midt.	Forenoon.												Noon.	Afternoon.												Midt.	Maximum reading and time.		Minimum reading and time.	
		0.	1.	2.	3.	4.	5.	6.	7.	8.	9.	10.	11.		1.	2.	3.	4.	5.	6.	7.	8.	9.	10.	11.						
		1	a	a	a	a	a	a	a	a	a	a	a		a	a	a	a	a	a	141	143	142	144	143	142					
2	141	140	139	134	134	134	135	135	138	137	130	134	131	132	134	134	134	134	135	136	137	139	138	137	139	1421	{ 0.5 a.m. 1.10 ,, }	1260	9.55 a.m.		
3	139	141	142	137	142	139	143	142	139	133	140	139	136	a	a	a	a	a	a	a	a	a	a	a	a						
4	a	a	a	a	a	a	a	a	a	a	a	a	a	a	a	a	a	a	a	a	a	a	a	a	a						
5	a	a	a	a	a	a	a	a	a	a	a	a	a	a	a	a	a	a	a	a	a	a	a	a	a						
6	142	141	140	138	140	136	138	144	147	147	146	145	140	139	141	141	143	144	144	145	145	145	147	146	145	1500	8.10 a.m.	1338	5.30 a.m.		
7	145	145	148	149	146	146	144	144	143	138	140	a	a	a	a	a	a	a	a	a	a	a	a	a	a						
8	a	a	a	a	a	a	a	a	a	a	a	138	137	136	136	136	138	140	141	144	143	143	144	142	141						
9	141	142	143	141	142	143	144	145	144	144	141	138	a	a	a	a	a	a	a	a	a	a	a	a	a						

DECEMBER, 1903.

V = .7... C.G.S.

Day.	Midt.	Forenoon.												Noon.	Afternoon.												Midt.	Maximum reading and time.		Minimum reading and time.	
		0.	1.	2.	3.	4.	5.	6.	7.	8.	9.	10.	11.		1.	2.	3.	4.	5.	6.	7.	8.	9.	10.	11.						
		12	a	a	a	a	a	a	a	a	a	a	a		a	a	a	111	109	110	111	112	112	113	113	113					
13	113	114	112	113	114	115	112	111	111	112	111	110	110	109	107	106	108	110	110	111	112	113	114	115	118	1186	12.0 p.m.	1064	3.15 p.m.		
14	118	120	120	118	116	114	113	111	108	104	098	096	096	096	111	110	113	113	113	112	112	114	114	114	114	1231	1.30 a.m.	0913	10.40 a.m.		
15	114	113	111	113	116	113	111	114	115	115	113	108	108	109	109	108	109	110	113	115	116	116	116	114	114	1179	9.30 p.m.	1051	11.22 ,,		
16	114	121	120	119	117	117	111	106	105	100	095	098	100	101	a	a	a	a	a	a	a	a	a	a	a						

JANUARY, 1904.

V = .7... C.G.S.

Day.	Midt.	Forenoon.												Noon.	Afternoon.												Midt.	Maximum reading and time.		Minimum reading and time.	
		0.	1.	2.	3.	4.	5.	6.	7.	8.	9.	10.	11.		1.	2.	3.	4.	5.	6.	7.	8.	9.	10.	11.						
		8	a	a	a	a	a	a	096	094	091	089	088		086	083	082	a	a	a	088	089	090	090	091	093					
9	095	096	097	098	095	093	091	092	a	a	a	a	a	a	a	a	a	085	086	087	088	090	a	a	a						
12	a	a	a	a	a	a	a	a	a	a	a	a	a	a	a	a	075	076	078	082	086	a	a	a	a						
15	a	a	a	a	a	a	a	a	a	a	a	a	094	092	092	091	090	088	a	a	a	a	a	a	a						
16	a	a	a	a	a	a	a	a	a	a	a	a	095	093	091	091	092	094	096	098	098	099	101	102	102						
17	102	103	102	100	099	100	103	100	100	096	093	090	090	089	090	090	092	096	099	103	a	a	a	a	a						

DAYS MADE USE OF IN CALCULATING DIURNAL INEQUALITIES.

(Days marked \* used for "Quieter Days.")

Month.	Element.		Number of days.‡
1902.			
March . . . . .	D	16 18 21 28 29 30	6
	V	16 18 19 20 25 28 29 30	8
April . . . . .	D	2* 3 4 5 6* 7* 8* 9 10* 13 14 18* 19* 20 22 23* 24 25* 26* 27* 28*	21 (12)
	H	13 18 19 20 21 23 24 25 26 27 28	11
May . . . . .	V	4 5 6 7 8 9 12 13 14 15 18 26	12
	D	2 3* 4 5* 6* 7* 8 9 16* 17* 18 19* 20 21* 22 25* 26* 27* 28* 29* 30 31*	22 (14)
June . . . . .	H	2 3 4 6 8 9 16 17 18 19 20 21 22 25 27 28 29 31	18
	V	2 3 5 6 7 8 9 17 18 19 20 21 22 28 29	15
July . . . . .	D	1 2* 3* 4* 5* 6 7 8 9* 12 13 14* 15 16 17* 18 19* 20* 21* 22 23 24* 25 26 27 28* 29 30	28 (12)
	H	1 2 3 4 5 6 7 8 9 12 14 16 17 18 20 22 24 25 27 28 29 30	22
August . . . . .	V	1 2 4 5 6 7 8 9 12 14 16 17 18 21 22 23 24 25 26 27 28 29 30	23
	D	1* 2* 3 4 5* 6* 7* 8* 9* 10* 11* 12 13* 14 15* 16 17* 18 19* 20* 21 22 23 24 26 27* 28* 29* 30* 31*	24 (20)
September . . . . .	H	1 2 3 4 5 6 9 11 12 13 14 15 16 17 18 21 22 23 27 28 29 30 31	23
	V	1 2 3 4 5 6 9 11 12 13 16 17 21 22 23 24 25 26 28 29 30 31	22
October . . . . .	D	1* 2* 3 4 5* 6* 7* 8* 9* 10 11 12 13* 14 15* 16 17* 18 19* 20* 21 23 24 25 26 27* 28* 29* 30 31	28 (13)
	H	1 3 4 5 9 10 13 14 15 16 17 18 19 20 23 24 25 26 27 28 29 30 31	23
November . . . . .	V	1 2 3 4 5 9 10 11 12 13 15 16 17 18 19 20 22 23 24 25 26 27 28 29 30 31	26
	D	1* 2 3 4 5* 6* 7* 8* 9* 10* 11* 12* 13 14* 15* 16* 18 21 22* 23 24 25* 26* 27* 30	25 (16)
December . . . . .	H	1 2 4 5 6 7 8 9 10 11 12 14 15 16 18 22 24 25 27 30	20
	V	1 2 3 5 7 8 9 10 11 12	10
January . . . . .	D	4 5* 6* 7* 8* 9 10* 11* 13 14 15 16* 17* 18 19 20* 21 22 23* 24 26 27 28	23 (10)
	H	6 7 8 9 10 13 16 17 21 23	10
February . . . . .	V	7 8 9 10 12 13 14 15 16 18 19 20 21 22 23 26 27 28 29	19
	D	2 3 4* 5* 6* 8 9* 10* 14 15 16 17 18* 19 20 21 22 23 27 28 29 30 (also except 15, 16, 21, 22, 23)	22 (6)
March . . . . .	H	4 5 6 9 15 16 17 18 19 20 28 29	12
	V	1 4 5 6 7 8 9 10 14 15 19 20 21 22 23 24	16
April . . . . .	D	1* 2 3* 4* 5* 6 7* 8 9 10 11 12* 13 14* 15 16* 17* 18* 20* 21* 22 23 24 25* 27 28 31*	27 (14)
	H	1 2 3 4 5 6 7 8 9 11 12 13 14 16 17 18 20 21 22 26 31	21
May . . . . .	V	1 3 4 5 6 7 8 9 10 14 15 17 22 24 25	15

‡ The figures in brackets relate to "Quieter Days."

DAYS USED FOR DIURNAL INEQUALITIES.

DAYS MADE USE OF IN CALCULATING DIURNAL INEQUALITIES.  
(Days marked \* used for "Quieter Days.")

Month.	Element.		Number of days.†
1903.			
January . . . . .	D	1* 2 3* 4 5 6 7* 8* 9 10 11 12 13 14 15* 16* 20 21* 22* 23* 24 29* 30 31*	24 (11)
	H	1 7 8 11 12 13 14 15 16	9
	V	1 6 8 11 12 13 14 15 16 22	10
February . . . . .	D	1* 2 5 7* 10 11 12 15 16* 17* 18* 19* 20 23* 24* 25* 26* 27* 28*	19 (12)
	H	1 2 5 7 19 23 26 27 28	9
	V	2† 3† 6† 7 8† 14† 15† 17† 18† 20† 21† 22 26	8
March . . . . .	D	1* 2 3 4* 5 6 8 9 10* 11* 12* 13 14 15* 16* 17* 18* 19 20 21* 22 24 25* 26* 27* 28* 29* 30	28 (15)
	H	1 4 10 11 15 16 17 18 19 20 22 24 26 27 28	15
	V	2 7 8 9 10 11 12 13 14 15 16 17 21 22 26 27 28 29 30 31	20
April . . . . .	D	1 2 3 4* 5 7 8 10 11 12 13* 14* 15 16 17* 18 19 20* 21 22* 23* 26* 29* 30*	24 (10)
	H	8 10 11 14 15 16 17 18 19 20 21 22 23 26 29 30	16
	V	1 2 3 4 5 8 9 12 13 22 23 26 30	13
May . . . . .	D	1* 2* 3* 4* 5 6 7 8 9* 10* 11* 12* 19* 20* 21* 30* 31*	17 (13)
	H	1 2 3 4 8 9 10 11 12 19 20 21 30 31	14
	V	1 2 3 4 5 6 7 8 9 10 11 12 19 20 21 30 31	17
June . . . . .	D	1* 2 3 4 5 6* 7* 10* 11* 12* 13* 14* 17 19 20 21* 22 23 24 25 26* 27* 28 29 30	25 (11)
	H	1 5 6 7 10 11 12 13 14 17 19 20 21 22 23 24 25 26 27 28 29	21
	V	1 2 3 4 5 6 7 10 11 12 13 14 17 19 22 26 27 28 29 30	20
July . . . . .	D	1 2* 3* 4* 5* 6 7* 8* 9* 10 11 12* 13* 14* 15* 18 19 20 21 22* 23* 24* 25* 26 27 28 29	27 (15)
	H	1 2 3 4 5 7 8 9 10 12 13 14 15 18 21 22 23 24 25 29	20
	V	2 3 4 5 6 7 8 9 10 11 12 13 14 15 18 19 20 21 22 23 27 28 29 30 31	25
August . . . . .	D	2* 3* 4* 5 6* 7* 8* 14 15 16* 17 18* 19* 20* 21 23 24 25 27 28 29 30 31	23 (10)
	H	2 3 4 6 7 8 16 18 19 20	10
	V	4 5 6 7 8 9 14 15 16 17 18 19 20 21 22 25 31	17
September . . . . .	D	1* 2* 3* 4* 5 6 7* 8 9 21 22* 23 30	13 (6)
	H	1 4 7	3
	V	1 2 3 4 5 6 7 8 9 21 22 23 24 30	14
October . . . . .	V	1 6† 7 8† 12 13† 15† 16 17 18† 26† 27 28†	9
November . . . . .	V	2† 3† 5† 6 7† 8† 9†	4
December . . . . .	V	12† 13 14 15 16†	4

† Use was made of part only of these days.

‡ The figures in brackets relate to "Quieter Days."

## DISCUSSION OF THE OBSERVATIONS.

BY

DR. C. CHREE, F.R.S.

## CHAPTER I.

## INSTRUMENTS AND RECORDS.

§1. The magnetographs used in the Antarctic were of the Eschenhagen pattern, constructed by O. Toepfer und Sohn, of Potsdam. As full descriptions are readily accessible,\* it is unnecessary to go into details here. The Declination, Horizontal Force and Vertical Force are recorded on a single drum. Answering to each element there is a separate base line, and there is further a record of temperature from a metallic thermometer inside the box of the Vertical-Force magnet. There are thus seven traces being simultaneously produced on each sheet. The photographic paper has a width of nearly 20 cms., and so long as there is little magnetic disturbance and only small variations of temperature, and the sensitiveness is similar to that customary in Europe, the difficulty of keeping the traces separate and all on the sheet is not very serious. In the Antarctic, however, the conditions were much less favourable than is usual. The magnetic elements possessed unusually large variations, both regular and irregular, whilst the changes of the external atmospheric conditions were such as to cause large fluctuations of temperature even inside the hut where the magnetographs were in action. The magnetographs arrived in this country from Germany at so late a date that no time remained for the observer or the staff at Kew to become really familiar with them, and it was unfortunately not discovered that the quartz-fibre suspensions for the Horizontal-Force magnet were all so fine as to give unduly high sensitiveness.

The sensitiveness of the Declination magnetograph is determined by the greater or less distance of the magnet from the photographic paper. In the Antarctic instrument it was approximately 1·5 per mm. of ordinate. Though rather low for ordinary latitudes, this proved much too high a sensitiveness for the conditions experienced.

The Vertical-Force magnet, as actually used, was by no means too sensitive; in fact, during most of the time its sensitiveness might with advantage have been at least doubled. It possessed, however, a high temperature coefficient, and this, in consequence of the large temperature changes encountered, tended to make the Vertical-Force trace shift across the paper. The large variations of temperature also gave a wide range to the trace from the metallic thermometer, which possessed a high sensitiveness.

The observer had to attempt to keep on the sheet three magnetic traces and a temperature trace, all four tending to shift their positions on the sheet, and two of them (the Declination and Horizontal-Force traces) subject to almost incessant fluctuations, which were not at all infrequently of the order of half the width of the sheet. Under these circumstances it is not surprising that traces not infrequently got off the sheet, and that those from different elements tended at times to become confused. Troubles of this kind were most serious near Midsummer, when the magnetic movements were largest.

§2. The source of light was an oil lamp which had to be filled daily. Any movement of the lamp moved the positions of all seven spots of light on the sheet simultaneously. The Vertical-Force trace, the temperature trace and the base line common to these two traces were altered together if the Vertical-Force instrument was moved. These traces could also be shifted independently by means of screws. Any movement of the Declination or the Horizontal-Force instrument altered the corresponding base line, and also, to some extent, the trace of the corresponding magnetic element. Thus the number of ways in which traces might have their position changed on the sheet was very large, while the instruments were so light that a slight touch might cause movement. As a rule, mechanical disturbances can be distinguished from true magnetic changes. The latter are seldom, if ever, absolutely sudden, and when magnetic changes occur which appear sudden on the ordinary slow-run magnetograph trace they are seldom confined to one element; they also, of course, have no effect on the base-line traces. Thus changes due to mechanical causes in the relative positions of the spots of light, though causing extra trouble to those

\* 'Terrestrial Magnetism,' vol. 5, 1900, p. 59 and Plate IV.

reducing the curves, are seldom a source of real uncertainty, provided they occur when the instrument is running. It is, unfortunately, otherwise with changes that take place when the instrument is not in action. At an ordinary station, it is true, supposing only a few minutes' trace lost whilst changing the sheets, an artificial shift of a trace can usually be detected at a glance, and at least a very approximate estimate be obtained of its amount. But in the Antarctic the conditions were not favourable for detecting artificial changes. The lamp had to be filled and trimmed, and there was not infrequently an interval of over 20 minutes between successive days' records. At times a trace was off the sheet when papers were changed. It will thus be readily understood that with elements perpetually altering—an alteration of 1' per minute in the Declination was quite an ordinary one—a very appreciable artificial shift in the trace of an element might occur during the changing time without the traces themselves suggesting it. In the case of the temperature trace and the Vertical Force, the observer on a good many occasions made a shift intentionally when changing the papers. He would, for instance, find the temperature trace off the sheet and bring it back. The extent of these changes was seldom much in doubt, because readings from a mercury thermometer afforded a check on the temperature record, while the Vertical Force was seldom much disturbed.

§3. When a change was detected or suspected, the conditions were examined into by myself, and when the existence of a change was accepted, allowance was made for it after full consideration of the circumstances.

In March, April, and September, 1902, and September, 1903, there were a good many interruptions in the record. Subsequent to September, 1903, only a few records were taken, as the photographic paper was nearly exhausted. At times, in very cold weather, the oil did not burn properly, and the trace became gradually fainter and finally invisible. On one or two occasions, during a blizzard, snow got into the magnetograph room and interrupted the record, and on one occasion a magnetograph suffered through the fall of some ice which had formed on the ceiling. The only satisfactory way of treating discontinuities in the base-line values that may occur on such occasions is by reference to the absolute observations. The primary object, of course, of absolute observations at a magnetic station furnished with a magnetograph is to determine base-line values. Under ordinary conditions, if one suspects a discontinuity, one simply compares the values given by the absolute observations for the base line before and after the date of the supposed discontinuity. In the Antarctic, unfortunately, with Declination changing half a degree or more during the course of an absolute observation, the results of a single observation are of no very high precision. To obtain information as reliable as that existing, for instance, at Kew—where absolute observations are taken once a week—it would have been necessary to observe at least once a day. As will be seen, however, on reference to Commander Chetwynd's discussion of the absolute observations, "Physical Observations," p. 133, the number of absolute observations available was really small.

§4. After these remarks it is perhaps unnecessary to say that the uncertainties entering into the *absolute* values of the elements as given in the various tables are *much* greater than would be the case at an ordinary European station. They are probably greatest in the case of the Vertical Force, *V*. This is derived from the Horizontal Force, *H*, and the Inclination, *I*, by the formula

$$V = H \tan I.$$

The absolute value of *V* corresponding to an observed Inclination *I* is deduced by multiplying  $\tan I$  by the corresponding value of *H*, as obtained from measurement of the Horizontal Force curve at the time of the dip observation. If *v* be the ordinate of the *V* curve in centimetres at this same time, and *s* the scale value (*i.e.* the equivalent in C.G.S. measure of 1 cm. of curve ordinate), then the base-line value *V*<sub>0</sub> is given by

$$V_0 = H \tan I - vs.$$

*H* was a quantity not far from 0.65, while *I* averaged about 84½°. Thus an error of 1' in *I* means an error of some 200γ (1γ ≡ 0.00001 C.G.S.) in the value of  $H \tan I$ . Accuracy to 0.5 in the dip derived from observations with two needles is considered good under the most favourable conditions, at places where the dip is from 60° to 70°. What it is reasonable to expect from a dip circle in the Antarctic it is impossible to say on our present knowledge. There can, however, be little doubt that even if we neglect the uncertainties in the values of *H*—and the uncertainty in an absolute observation was probably nearer 1/500 than 1/1000 of *H*—the uncertainty in the base-line values of the *V* curves was too large to admit of discontinuities of the order of 100γ being detected by reference solely to the base-line values.

§5. The Declination magnetograph remained at a fixed distance from the recording drum and its suspension was unaltered, so the scale value was accepted as constant. The light from the lamp, emerging from a narrow slit, traverses a slightly convex lens forming a window to the magnet box, is reflected from a plane mirror carried by the magnet, passes a second time through the lens window, and eventually falls on the photographic paper, after passing through a hemi-cylindrical lens a little in front of the paper. The thickness of the hemi-cylindrical lens, approximately 0.5 cm., and the focal length of the lens window, about 120 cm., exercise a slight effect on the scale value; but for practical purposes it depends essentially on the distance of the plane mirror from the photographic paper. The scale value calculated from the optical conditions in the Antarctic was 1 mm. = 1'.43. This requires, however, a small correction for the torsion of the suspension, a very fine quartz fibre. This suspension returned safely to Europe, and independent observations by Mr. BERNACCHI and the Kew staff—in which the torsion head was twisted through  $\pm 180^\circ$ —made the torsion correction very approximately  $4\frac{1}{4}$  per cent. The scale value for the Antarctic curves was thus taken as 1 mm. = 1'.50.

§6. The scale values of the Horizontal- and Vertical-Force magnetographs were determined from time to time in the Antarctic by means of one or other of the collimator magnets 25A and 25D supplied with the unifilar magnetometer. In the case of the Horizontal-Force magnetograph, the magnet was placed horizontally in front of the recording drum in the magnetic Meridian. A paper being on the drum, the position of the spot of light was recorded photographically with the magnet as originally laid down and when turned end for end. The whole operation was repeated at least once on each occasion. The double deflection, *i.e.*, the distance between the two deflected positions of the spot of light, answers to a change of very approximately  $4m/r^3$  in the Horizontal Force,  $r$  being the distance between the centres of the deflecting and the deflected magnets (usually at least 150 cms.), and  $m$  the moment of the magnet at the time. The change in  $m$  was small and slow, so that a sufficiently approximate value was derivable from the ordinary absolute observations. The procedure in the case of the Vertical Force was practically the same except that the collimator magnet was held vertically over the Vertical-Force magnet. The scale values thus found and the values actually employed are recorded in Table I.

TABLE I.—Scale Values.

Value of 1 cm. of ordinate in terms of  $1\gamma$  ( $1\gamma \equiv \cdot 00001$  C.G.S.).

Date.	Observed Values.		Values Accepted.	
	Horizontal Force.	Vertical Force.	Horizontal Force.	Vertical Force.
1902				
March 19 . . . . .	—	171		
April 15 . . . . .	14.0	160	14.0 { From March to August 19	165 { From March to May 31.
May 1 . . . . .	14.0	165		
June 19 . . . . .	14.4	145		145 in June.
				135 in July.
				125 in August.
September 5 . . . . .	6.3	119	6.7 { From August 21 to November 12	119 { From September 1 to 12.
” 9 . . . . .	6.7	—		32 { From September 22 to November 12.
November 6 . . . . .	6.8	32	9.6 { From November 14 to January 17	72 { From November 14 to December 31.
December 29 . . . . .	9.6	72		
1903				
March 11 . . . . .	7.5	83	7.5 { From January 19 to March 31	83 { From January 1 to March 31.
May 19 . . . . .	9.8	162	10.0 { From April 1 to end	162 { From April 1 to end.
July 1 . . . . .	9.7	154		
” 27 . . . . .	9.9	158		
November 2 . . . . .	—	178		
1904				
January 17 . . . . .	10.5	159		

§7. On December 31, 1902, an important change was made in the Vertical-Force magnetograph. That instrument is fitted with three auxiliary magnets. Two are thin bars, almost wires, one on either side of the Vertical-Force magnet, with their centres near its level. The third is a short, much thicker bar, in a brass piece which screws on to the base of the Vertical-Force box, at some distance under the Vertical-Force magnet. These auxiliary magnets are intended apparently to assist in reducing the temperature coefficient. The use of auxiliary magnets is one of which the wisdom is open to much doubt. The results are of a somewhat complicated character, and any unrecognised change of moment or position in an auxiliary magnet may cause error and confusion. The auxiliary magnets in the present case may be described as of "soft" iron, but still they possess very appreciable "permanent" moments. In December, 1902, the temperature changes in the Antarctic were large, and Mr. BERNACCHI, noticing a large temperature effect on the Vertical-Force trace, made a serious attempt to reduce it. After trying several less heroic remedies, he finally removed the short magnet from its place below the magnet box and placed it above, where it remained until the instruments were finally dismantled.

When the tabulations were commenced at Kew, it was feared that nothing could be made of the Vertical-Force records. There were occasions when the instrument was obviously out of action, while on many occasions the Vertical-Force trace appeared so extraordinarily quiet compared to the others as to raise suspicions. Eventually I decided to have two months' trace measured, selecting December, 1902, and February, 1903, as months when the Vertical-Force changes seemed specially large and the information as to the scale values most complete. Even a superficial inspection of the sheets at times of large temperature change showed that the influence of temperature on the Vertical-Force trace must be considerable. But having had the 2-hour readings of Antarctic temperature through my hands, I knew that the *regular* diurnal variation of atmospheric temperature had a range of at most 3° or 4° F., and I thence inferred—wrongly, as it proved—that inside the Magnetic Hut the regular diurnal inequality of temperature would be so small even at Midsummer that its effect on the Vertical-Force diurnal inequality might be neglected without risk of serious error. I realised, of course, that this neglect might prejudice seriously individual curve readings, but for my immediate object that did not matter. Accordingly, diurnal inequalities were got out for December, 1902, and February, 1903, from the Vertical-Force curves uncorrected for temperature. The ranges appeared surprisingly large, and the inequality in the one month was inverted as compared to the other. This pointed to something being wrong. On inspecting the curves it was apparent that rise of temperature was associated with movement of the Vertical-Force trace down the sheet in 1902, but movement up the sheet in 1903. The explanation that may appear most natural—viz., that there had occurred an actual change in sign in the temperature coefficient—postulated conduct so contrary to my previous experience of magnetographs, that after reflection I inclined to the view that the Vertical-Force magnet must somehow or other have got turned end for end between December, 1902, and February, 1903. Minute inspection of the curves fixed the date of this supposed occurrence as December 31, 1902. Investigation of the written records then showed that on this afternoon Mr. BERNACCHI had made the alteration mentioned above in the position of the short magnet, and as the alteration entailed a rebalancing of the magnet whose ends are closely alike, he agreed with me in regarding the occurrence as at least a possible one. Experiment showed that the magnet worked equally well whether its N. end were east or west. The natural way of settling the question was to refer to the information on the sheets of scale-value determinations as to the position of the deflecting magnet, whether N. pole up or S. pole up. Information on this point was given, however, only on some of the sheets, and the different sheets for 1903 contradicted one another. When making the deflection experiment, the observer had to hold the magnet close up to the ceiling in the dark, and had to rely on his memory as to how he held it. Naturally it never occurred to him that circumstances might introduce an uncertainty as to the sign even of the Vertical-Force change.

The difficulty, of course, would not have arisen if temperature coefficients had been determined in the Antarctic before and after changes of the instrument, but no determinations had been found practicable.

§8. Though I did not at first think it possible that differences so large as those presented by the diurnal inequalities found for December, 1902, and February, 1903, could arise from temperature alone, inspection of the curves led me to suspect that the regular diurnal inequality of temperature in the Magnetic Hut

during these months must have been much larger than I had supposed, and I decided that some means must be devised for eliminating its effects. The absolute sign of the Vertical-Force changes during 1903 was, as already explained, in doubt, but there was no ambiguity either in 1902 or 1903 as to the direction in which rise of temperature deflected the Vertical-Force trace. It was thus apparent that if one could determine the change of Vertical-Force ordinate answering to a rise of  $1^{\circ}$  in temperature, one could—from the trace of the metallic thermometer—eliminate the effects of temperature, whatever their sign might prove to be.

Thanks to the large irregular changes of the Antarctic temperature, the task proved simpler than anticipated. The method adopted was one which I have found to work successfully in several cases. The principle is that if one can get a number of instances in which there is a large change of temperature in the course of 24 hours, a coefficient calculated by assigning the 24-hour apparent change of Vertical Force to temperature alone will not be much in error. There are, of course, individual occasions when the true values of Vertical Force at the same hour on two successive days differ considerably; but still, if one is dealing with 20 or 30 days on which no specially large magnetic disturbance has occurred, the effects of natural magnetic changes will in most instances be very nearly eliminated. In most months there were fairly copious temperature data from the trace given by the thermometer inside the Vertical-Force box, standardised by reference to the readings of the mercury thermometer. Numerical values having been obtained for the temperature coefficient, hourly measurements were made of the temperature trace, and corrections were thus obtained to the diurnal inequalities already calculated for December, 1902, and February, 1903. Considerably to my surprise, the result was not merely a large reduction of the range in each case, but a complete inversion of the inequality for February.

§9. A difference of sign between the true inequalities of Vertical Force for December and February appearing highly improbable, I came to the conclusion that the hypothesis that the magnet had been changed end for end on December 31, 1902, must be wrong, and that there must in reality have been a change of sign in the temperature coefficient. To obtain further light on the subject, two direct determinations were made at Kew of the temperature coefficient, the soft-iron bar being on one occasion in the position it occupied during 1902, on the other occasion in the position it occupied during 1903. The coefficients obtained differed notably in size, but they agreed in sign. At first sight this was rather staggering, but surmising the true explanation of the phenomenon, I had a further determination made under conditions as similar as possible to those at Winter Quarters. With the aid of a number of bar magnets it proved possible to produce at the position of the Vertical-Force magnet a fairly uniform vertical field of about  $-72$ , the natural field at Kew being about  $+44$ , and now, much to my relief, the expected difference in sign appeared. With the soft-iron bar below the Vertical-Force magnet, as in 1902, the trace went down the sheet as temperature was raised; with the soft iron on the top of the magnet box the reverse happened. The experiments were made with both rising and falling temperatures, the readings being taken by Mr. T. W. BAKER and Mr. G. W. WALKER quite independently of me, and the results appeared quite decisive in favour of the view that the Vertical-Force magnet was not altered in position in December, 1902—movement up the sheet meaning increase of force throughout—but that the temperature coefficient was negative in 1902, and positive in 1903. This view was thus finally accepted. If any additional evidence in its favour is thought necessary, it will be found in the general consistency of the results for the diurnal inequalities in Table XVIII. In several individual months the corrections from temperature to the mean diurnal inequality exert but a trifling effect on its nature, and it is out of the question that the diurnal inequalities in corresponding months of 1902 and 1903 should be the antitheses of one another.



## CHAPTER II.

## BASE-LINE VALUES, ANNUAL INEQUALITY, AND SECULAR CHANGE.

§10. Table II gives particulars of the values given by the absolute observations for the base line of the Declination curves and the mean values for individual months as calculated and used. In the calculations regard was sometimes paid only to the observations of the particular month, as in May, 1902 and 1903; but in most cases the observations in adjacent months were also considered. Thus the calculated value for June, 1902, is the arithmetic mean of the observed results on May 26 and June 30. In no case was anything taken into account except the results of the absolute observations.

The base line was assumed to have a constant value for each month. In passing from one month to the next the change in the assumed value of the base line introduces a discontinuity, the amount of which is shown in the last column of Table II. If the base-line value accepted for the second of two consecutive months is higher than that accepted for the preceding month, then the first midnight of the second month appears with a correspondingly higher Declination than the last midnight of the preceding month. The

TABLE II.—Values of the Declination Base Line.

Date.	Observed values.	Monthly mean values.		Discontinuity.
		Calculated.	Accepted.	
1902				
May 13 . . . . .	151 30.3			
" 26 . . . . .	150 3.9	150 47.1	150 47*	
June 30 . . . . .	149 43.3	149 53.6	149 54	-53
July 5 . . . . .	149 17.4			
" 21 . . . . .	149 4.5			
" 22 . . . . .	148 59.7	149 7.2	149 7	-47
August . . . . .	—	148 55.5	148 56	-11
September 5 . . . . .	148 51.3	148 51.3	148 51	-5
October 21 . . . . .	148 39.6	148 57.6	148 58	+7
November 4 . . . . .	148 35.3			
" 12 . . . . .	148 33.8	148 59.7	149 0	+2
December 5 . . . . .	149 16.2			
" 27 . . . . .	149 35.1	149 25.7	149 26	+26
1903				
January 7 . . . . .	149 40.5			
" 30 . . . . .	150 20.0	150 0.2	150 0	+34
February 10 . . . . .	150 35.2			
" 15 . . . . .	150 36.1	150 35.6	150 36	+36
March 10 . . . . .	150 22.6	150 22.6	150 23	-13
April . . . . .	—	149 40.8	149 41	-42
May 19 . . . . .	148 59.1	148 59.1	148 59	-42
June 23 . . . . .	148 52.8	148 52.8	148 53	-6
July . . . . .	—	148 46.4	148 46	-7
August 21 . . . . .	148 40.0			
" 31 . . . . .	148 30.1	148 36.7	148 37	-9
September 29 . . . . .	148 51.8			
" 30 . . . . .	148 45.6	148 42.5	148 43	+6
October . . . . .	—	148 48.2	148 48	+5
November 2 . . . . .	148 47.8	148 47.8	148 48	0
December . . . . .	—	148 44.7	148 45	-3
1904				
January 12 . . . . .	148 41.6			
" 17 . . . . .	147 52.5	148 17.0	148 17	-28

\* Applied also during March and April, 1902.

two hours are of course the same, and the apparent difference between the Declinations assigned to them is wholly fictitious.

The existence of such apparent discontinuities is of course undesirable. What they really imply in the present case it is impossible to say. They are contributed to, no doubt, by observational errors; but even in the Antarctic it seems unlikely that errors of more than 5' or 6' would arise in absolute observations

taken by a practised observer like Mr. BERNACCHI. On the other hand, it is difficult to imagine what natural cause could lead to alterations of 50' or even of 30' per month in the base-line value of a Declination magnetograph, the alteration continuing for several months in the same direction. The base line, it need hardly be mentioned, is due to light reflected from a mirror, which is supposed to be fixed, on to photographic paper on a drum which is also fixed. In the Kew magnetograph it is doubtful whether the total alteration in the base line between 1890 and 1900 attained to as much as 1'.

§11. Table III gives the values deduced for the base line of the Horizontal-Force curves from individual observations, the values thence calculated for individual months, and the values actually used. The last column gives the excess of the base-line value for each month over that for the previous month. As already explained in the case of the Declination, the differences between the base-line values accepted for successive months appear as discontinuities—modified in April, 1903, by a change of scale value—between the values assigned respectively to the first midnight of a month and the last midnight of the previous month. As with the Declination, it is difficult to account for the large apparent variations in the base-line value. Owing to the limited number of absolute observations, observational errors doubtless come in; but they can hardly account for any large fraction of the larger discontinuities. The collimator magnets used for the absolute observations were old, and there was but little change in their magnetic moments, especially in that of 25A, the magnet chiefly employed. If the absolute observations had been faulty—a circumstance improbable in view of Mr. BERNACCHI'S experience—this would have shown itself through irregularity in the values given by the individual observations for the moment of 25A. The accordance, however, in the values for the moment is satisfactory and suggests that the probable error in individual absolute observations of Horizontal Force was at most from 10γ to 20γ. Moreover, errors in the absolute determinations would naturally vary irregularly in sign, while the apparent monthly changes in the values of the base line in Table III appear on the whole systematic.

TABLE III.—Values of the Horizontal-Force Base Line.

Date.	Observed values.	Monthly mean values.		Discontinuity. (Unit 1γ.)
		Calculated.	Accepted.	
1902				
April 17 . . . . .	·06371	·06371	·06370*	
May 12 . . . . .	·06228			
" 26 . . . . .	·06314	·06271	·06270	-100
June 30 . . . . .	·06375	·06345	·06345	+ 75
July 23 . . . . .	·06414	·06394	·06395	+ 50
August . . . . .	—	·06511	·06510†	+115
September 5 . . . . .	·06608	·06608	·06610	+100
October 21 . . . . .	·06626	·06626	·06625	+ 15
November 12 . . . . .	·06515			
" 12 . . . . .	·06504	·06510	·06510	-115
December 27 . . . . .	·06247	·06298	·06300	-210
1903				
January 7 . . . . .	·06207			
" 30 . . . . .	off sheet	·06207	·06205	- 95
February . . . . .	—	·06210	·06210	+ 5
March 10 . . . . .	·06214	·06214	·06215	+ 5
April . . . . .	—	·06368	·06370	+155
May 19 . . . . .	·06523	·06523	·06525	+155
June 28 . . . . .	·06619	·06600	·06600	+ 75
July . . . . .	—	·06656	·06655	+ 55
August 31 . . . . .	·06768	·06731	·06730	+ 75
September . . . . .	—	·06778	·06780	+ 50
October . . . . .	—	·06800	·06800	+ 20
November 2 . . . . .	·06810	·06697	·06695	-105
December . . . . .	—	·06470	·06470	-225
1904				
January 17 . . . . .	·06244	·06244	·06245	-225

\* Applied also during March. May base-line value used after Noon on April 22.

† After August 20, September base-line value applied.

§12. Table IV shows two sets of mean values of Declination for individual months derived from the hourly readings, accepting the base-line values given in Table II. The first set of data are derived from all the days of complete registration; the second set are derived from a smaller number of days, selected as the least disturbed of the month. The *differences* between these two sets of values given in the last column would be unaffected by any alteration in the monthly values accepted for the base lines. The smallness of these differences seems to justify the conclusion that they are not seriously affected by the incidence of magnetic disturbances or by uncertainties in the measurements of individual days' curves. Whilst the differences are small, the all-days' mean appears in excess in so large a majority of cases as strongly to suggest that the phenomenon is not a purely accidental one. Differences between mean values derived from all and from quiet days have been observed elsewhere, though not of so large a size.

TABLE IV.—Mean Monthly Values of Declination (from the Curves), employing the Base-Line Values accepted in Table II.

Month.	Monthly means from		Excess of all-days' mean.
	All days.	Quieter days.	
1902	° /	° /	/
May . . . . .	153 39·6	153 41·1	-1·5
June . . . . .	153 2·7	153 1·1	+1·6
July . . . . .	152 37·0	152 36·7	+0·3
August . . . . .	152 37·9	152 37·7	+0·2
September . . . . .	152 40·0	152 37·5	+2·5
October . . . . .	152 54·2	152 49·5	+4·7
November . . . . .	152 49·2	152 48·9	+0·3
December . . . . .	152 46·1	152 42·9	+3·2
1903			
January . . . . .	152 45·2	152 47·9	-2·7
February . . . . .	153 0·9	152 59·7	+1·2
March . . . . .	152 46·1	152 45·2	+0·9
April . . . . .	152 19·4	152 21·5	-2·1
May . . . . .	151 56·5	151 56·9	-0·4
June . . . . .	152 10·6	152 7·2	+3·4
July . . . . .	152 17·8	152 16·1	+1·7
August . . . . .	152 30·2	152 22·1	+8·1
September . . . . .	152 48·7	152 45·3	+3·4
Mean excess of all-days' over quieter-days' mean . . . . .			+1·46

§13. Table V gives the mean monthly values of the Horizontal Force as derived from the hourly values in days of complete registration, accepting the base-line values given in Table III.

TABLE V.—Mean Monthly Values of Horizontal Force (from Curves), employing the Accepted Base-Line Values in Table III.

Month.	1902.	1903.
January . . . . .	—	·06344
February . . . . .	—	·06334
March . . . . .	—	·06335
April . . . . .	·06558	·06534
May . . . . .	·06503	·06673
June . . . . .	·06584	·06735
July . . . . .	·06622	·06780
August . . . . .	·06721	·06838
September . . . . .	·06718	·06873
October . . . . .	·06749	—
November . . . . .	·06627	—
December . . . . .	·06437	—

§14. A comparison of the mean values of an element for corresponding months of consecutive years enables an estimate to be formed of the rate of secular change.

Table VI shows the results thus found for D and H, accepting the monthly mean values given in Tables IV and V for the five months May to September. The data subsequent to September, 1903, were too few to give representative results, while during March and April, 1902, matters were still somewhat in a preliminary stage.

TABLE VI.—Secular Change.

Mean value from month of 1903 — Mean value from same month of 1902.		
Month.	Declination.	Horizontal Force.
	°   '   ''	
May . . . . .	-1 43·1	+ ·00170
June . . . . .	-0 52·1	+ ·00151
July . . . . .	-0 19·2	+ ·00158
August . . . . .	-0 7·7	+ ·00117
September . . . . .	+0 8·7	+ ·00155
<b>Means . . . . .</b>	<b>-0 34·7</b>	<b>+ ·00150</b>

The results for the secular change in H show a rather unexpected consistency. The only suspicious feature in the figures, as figures, is the extraordinarily large size of the apparent annual change, representing as it does nearly 2½ per cent. of the absolute value of the Horizontal Force. If the mean is a true measure of the secular change, the natural inference is that the south magnetic Pole is receding from Winter Quarters—*i.e.*, is moving northwards—at a rapid rate.

The Declination figures are no less remarkable, but appear much less consistent. Starting with an apparent decrease of 103'·1 in the year ending with May, 1903, we finish with an apparent increase of 8'·7 in the year ending with September, 1903.

Such a phenomenon seems hardly credible, and one cannot but suspect some instrumental source of error. In the case of the Declination, as already stated, there is no apparent reason why the base line should change, and it is conceivable that some seasonal change may have influenced the absolute observations, especially in view of the apparent inconsistencies in the azimuth readings obtained for the distant mark ("Physical Observations," p. 139). I have thus thought it worth while to ascertain what results would be obtained for the secular change of Declination if the base-line value were assumed to be invariable. On this hypothesis the results given in Table VI are replaced by those in the following Table VII.

TABLE VII.—Secular Change of Declination.

Mean value from month of 1903 — Mean value from same month of 1902.					
May.	June.	July.	August.	September.	Mean.
+4'·8	+8'·8	+1'·7	+11'·2	+16'·6	+8'·6

The results given in Table VII are the antithesis of those in Table VI, and are more consistent amongst themselves. Whilst Table VI suggests that the south magnetic Pole is moving towards the west, Table VII suggests that it is moving towards the east.\*

§15. In even the best European stations two years is too short a period to give results of a really representative character for the annual inequality of the magnetic elements, *i.e.* the variation that remains in the

\* The results obtained for the secular change by Commander CHETWYND, R.N., from the absolute observations alone, disregarding diurnal variation, were for Declination -26'·4, for Horizontal Force +130γ ("Physical Observations," pp. 137, 140).

mean monthly values after an allowance has been made for the effects of secular change, assumed to proceed at a uniform rate throughout the year. This is due, at least in the case of the Declination, to the fact that the regular annual inequality in temperate Europe is not absolutely nil, is exceedingly small. Table VIII gives the results obtained for the annual inequality at Winter Quarters. In obtaining the Horizontal-Force results, the mean monthly values were taken from Table V, and the secular change accepted was the mean given in Table VI. The Declination results under both (i) and (ii) are based on all the days of registration. The results under (i) accept the mean monthly values given in Table IV, and the mean value given in Table VI for the secular change, *i.e.*, they answer to a variable base line as given by the absolute observation. The results under (ii) assume the base-line value to be invariable, and the true value of the secular change to be the mean given in Table VII.

TABLE VIII.—Annual Inequality.

Month.	Declination.		Horizontal Force. (Unit 1 $\gamma$ .)
	(i.)	(ii.)	
January . . . . .	+ 2.5	-28.5	-237
February . . . . .	+21.1	-49.5	-260
March . . . . .	+ 9.2	-52.0	-271
April . . . . .	-14.6	-37.4	+ 3
May . . . . .	- 0.4	-16.6	+ 32
June . . . . .	- 8.9	+ 0.8	+ 91
July . . . . .	-15.3	+17.8	+120
August . . . . .	- 5.8	+33.7	+186
September . . . . .	+ 7.4	+42.3	+189
October . . . . .	+ 2.9	+44.8	+205
November . . . . .	+ 0.8	+37.0	+ 71
December . . . . .	+ 0.6	+ 7.2	-132

The range given for the annual inequality by any set of figures in Table VIII is simply enormous compared to anything that exists in ordinary latitudes. The two sets of figures for the Declination are far from similar. Those under (i) look at first sight the less improbable, as giving the smaller range. It should, however, be remembered that at Winter Quarters 1' of arc in Declination answered to only about 1.9 $\gamma$  in force, so that the range under (ii) when converted into force is only about 184 $\gamma$ , or 40 per cent. of the apparent range in Horizontal Force. Thus if a large range in an annual inequality is regarded as too improbable a result to be accepted, the argument is not so strong against the Declination results under (ii) as against the Horizontal-Force results.

§16. If we take a Midsummer mean from the months November, 1902, to February, 1903, and a Midwinter mean from the months May to August of both years combined, both the epochs concerned centre at January 1, 1903, so that the results are free from the uncertainty as to the real value of the secular change.

The results thus obtained are as follows:—

Season.	Declination on hypothesis of		Horizontal Force.
	Variable base line.	Fixed base line.	
Midsummer . . . . .	152 50.3	—	.06436
Midwinter . . . . .	152 36.5	—	.06682
Excess of Midsummer . .	+13.8	-17.4	- .00246

In view of what has been already said and of the difference between the Declination results under (i) and (ii) in Table VIII, it is, perhaps, unwise to say more than that it is desirable that the attention of the observers of the next Antarctic Expedition should be called to the importance of making a careful study of the annual inequality. If an inequality with a range of the order suggested by Table VIII should be established, it would be a most important result, strongly suggestive of an annual oscillation in the position of the S. Magnetic pole.

The question may be asked why a second set of results answering to those in Table VII and to those under (ii) in Table VIII has not been given for the Horizontal Force. The reason is simply that the Horizontal-Force base line inevitably changes with time as the moment of the suspended magnet alters, and there is the further reason that a discontinuity arose more than once through breakage of the suspension, or similar disturbing cause. A diminution in the moment at the rate of 1 per cent. per annum would have had at Winter Quarters the same apparent effect as a secular change of 65γ per annum, and it is by no means improbable that the change of moment amounted to several per cent. as the magnet was exposed to large and numerous changes of temperature.

§17. Table IX shows the Vertical-Force base-line values observed (*i.e.* derived by combining observed values of dip with the corresponding values given by the Horizontal-Force curves) and those actually employed. As already explained, the probable error in the value of V (Vertical Force) derived from a single observation of dip is very large. This made it advisable to derive base-line values from the observations of a number of months combined, when this appeared feasible, allowing for apparent curve discontinuities. Thus the base-line values up to September 12, 1902, were determined by combining the absolute observations of dip made in April, May, June, July and September. The base-line values from October 1 to November 12 depend on the absolute observation of October alone. The base-line values for the latter part of November, 1902, and up to the end of January, 1903, depend on the observation of December. The base-line value for February, 1903, is from the absolute observation of that month. From March to October, 1903, the base-line values depend on the observations of March, May, June, August and September combined, allowing for apparent curve discontinuities. The base-line values for November, 1903, and January, 1904, depend on the absolute observations of these respective months, and the base-line value for December, 1903, was interpolated.

It is obvious from what has been already stated that the Vertical-Force base lines for individual months are affected by uncertainties which would render any deductions as to secular change or annual inequality of very problematical value.

TABLE IX.—Vertical-Force Base-Line Values.

Month.	1902.			1903.		
	Date of observation.	Observed value.	Accepted value.	Date of observation.	Observed value.	Accepted value.
January . . . . .	—	—	—	—	—	·7348
February . . . . .	—	—	—	10	·73407	·7341
March . . . . .	—	—	·7349	10	·72508	·7301
April . . . . .	17	·72720	·7349	—	—	·7414
May . . . . .	12	·73506	·7331	19	·73933	·7386
June . . . . .	30	·73229	·7302	28	·73574	·7368
July . . . . .	23	·72430	·7290	—	—	·7357
August . . . . .	—	—	·7283	31	·73740	·7336
September . . . . .	5	·73548	·7273	30	·73711	·7355
October . . . . .	21	·73111	·7311	—	—	·7352
*November . . . . .	28	·73278	·7311	2	·73348	·7335
December . . . . .	27	·73142	·7321	—	—	·7306
			·7314	Jan. 17, 1904	·72770	·7277

\* Of the two values given for November, 1902, the first was applied up to and including the 12th, the second for the rest of the month.

§18. Table X contains data relating to the temperature correction to the Vertical Force. They were obtained by intercomparing the temperatures recorded by a mercury thermometer adjacent to the Vertical-Force instrument, at the times when the sheets were put on and taken off, with the readings of the temperature trace and Vertical-Force curve at the beginning and end of each sheet. Sometimes, of course, the natural values of  $V$  at the beginning and end of a day's trace differ considerably owing to magnetic disturbance. Again, at times when temperature was changing rapidly it is improbable that the temperature of the mercury thermometer, the metallic thermometer and the Vertical-Force magnet were really identical. Uncertainties also arose from discontinuities in the temperature trace and Vertical-Force curve.

Comparing the changes during the 24 hours in the temperature trace with the corresponding changes in the readings of the mercury thermometer, one obtained the number of millimetres in the temperature trace answering to  $1^{\circ}\text{C}$ . The mean results thus obtained from the curves of individual months form the first column of Table X. Taking everything into account, I concluded that from March, 1902, to the end of February, 1903, there was no evidence of any real change in the scale of the metallic thermometer. Accordingly the mean value 16 mm. per  $1^{\circ}\text{C}$ . was accepted for these twelve months.

Subsequent to February, 1903, for some unknown reason, the temperature scale was much less open and at the same time more variable. This continued until nearly the end of the year, when the scale again reverted to nearly its original value. During the last three months a common value of 14.8 mm. per  $1^{\circ}\text{C}$ . was accepted, but from March to September, 1903, use was made of the individual monthly values actually found.

TABLE X.—Vertical Force. Temperature Correction.

Month.	Temperature scale, equivalent of $1^{\circ}\text{C}$ .	Correction to apparent $V$ per $1^{\circ}\text{C}$ . rise of temperature. (Unit $1\gamma$ .)	Correction answering to 1 mm. change of ordinate of temperature curve.	
			In millimetres of $V$ -trace.	In force. (Unit $1\gamma$ .)
1902				
March . . . . .	mm. 14.7	+ 41	0.154	2.5
April . . . . .	15.8	43	0.165	2.7
May . . . . .	15.7	40	0.152	2.5
June . . . . .	16.3	36	0.155	2.2
July . . . . .	16.8	30	0.139	1.9
August . . . . .	14.4	40	0.200	2.5
September (to 12th) . . . . .	16.5	34	0.178	2.1
October . . . . .	16.6	22	0.426	1.4
November (to 12th) . . . . .	16.2	26	0.500	1.6
„ (after 14th) . . . . .	19.8	35	0.30	2.2
December . . . . .	15.7	+ 35	0.30	2.2
1903				
January . . . . .	16.4	-21	0.16	1.3
February . . . . .	16.4	17	0.125	1.0
March . . . . .	5.9	17	0.355	2.9
April . . . . .	4.1	22	0.327	5.3
May . . . . .	3.8	18	0.291	4.7
June . . . . .	3.6	14	0.240	3.9
July . . . . .	3.3	22	0.414	6.7
August . . . . .	3.5	21	0.371	6.0
September . . . . .	3.1	15	0.298	4.8
October . . . . .	—	—	0.361	5.8
November . . . . .	} 14.8	-22	0.094	1.5
December . . . . .				
1904				
January . . . . .				

Comparing the daily changes in the temperature trace with the corresponding changes in the Vertical-Force ordinate, one got for each month—assuming the effects of magnetic disturbances to neutralise one another—the apparent change of Vertical-Force ordinate in millimetres answering to a change of 1 mm. in temperature trace; while comparing the daily changes in the readings of the mercury thermometer with the corresponding changes in the Vertical-Force ordinate, one got the apparent change of Vertical-Force

ordinate in millimetres for a change of 1° C. From a mathematical standpoint the two sets of results just mentioned are not independent, the one being deducible from the other by means of the relationships given in the first column of Table X. In reality, however, the two sets of results were to some extent independent, because there were in all months days—sometimes a good many days—in which information was lacking as to the mercury temperature, the temperature trace or the Vertical-Force curve, and the loss was sometimes of one element, sometimes of another. The third column of Table X is in most months based on both sets of results (*i.e.* on Vertical-Force and mercury-temperature changes as well as on Vertical-Force and temperature-trace changes), allowing most weight to the direct Vertical-Force and temperature-trace comparisons. The second and fourth columns in Table X are calculated from the third column, employing the accepted scale values of the Vertical-Force curve and the temperature trace. Any uncertainty in the scale value of the Vertical-Force curve thus affects these two columns, but it does not—and this is important—have any influence on the accuracy of the temperature correction actually applied to the readings of the Vertical-Force curve. The ordinates of the Vertical-Force curve and temperature trace were read in millimetres, and for each millimetre change of ordinate of the temperature trace a corresponding correction in millimetres was applied to the Vertical-Force ordinate. There is not the slightest doubt that the application of the temperature corrections immensely improved the accuracy of the Vertical-Force results—in fact, in some of the Midsummer months the results if uncorrected for temperature would have been practically useless—but considering the many changes of scale value and other sources of uncertainty it would be too much to hope for complete success.

§19. The uncertainties remaining after the application of the temperature correction increase, of course, with the probable error in the calculated value of the temperature coefficient, which there is no satisfactory means of estimating, but they are equally dependent on the range of temperature of the Vertical-Force magnet. So far as the regular diurnal inequality of V is concerned, it is only the regular diurnal change of temperature that counts. It is the range of this regular diurnal change that appears in the first column of Table XI. It is derived from the temperature trace on those days which were actually used in deducing the diurnal inequalities of V in Table XVIII.

TABLE XI.

Month.	Range, C.	Hours of		Equivalent of temperature range. (Unit 1γ.)	Range of corrected V-inequality. (Unit 1γ.)
		Highest temperature.	Lowest temperature.		
1902.					
March . . . . .	2·38	4 p.m.	midnight	97	37
April . . . . .	1·10	2 "	"	48	46
May . . . . .	1·40	6 "	noon	56	19
June . . . . .	0·53	7 a.m.	10 p.m.	19	22
July . . . . .	0·47	6 "	midnight	14	15
August . . . . .	0·46	midnight	noon	18	22
September . . . . .	1·37	7 p.m.	11 a.m.	46	26
October . . . . .	1·31	6 "	6 "	29	27
November . . . . .	—	—	—	—	46
December . . . . .	4·16	3 p.m.	4 a.m.	145	51
1903.					
January . . . . .	6·33	3 p.m.	midnight	135	80
February . . . . .	—	—	—	—	52
March . . . . .	4·31	2 p.m.	1 a.m.	75	52
April . . . . .	0·40	2 and 3 p.m.	9 p.m.	9	35
May . . . . .	0·37	2 p.m.	7 "	7	25
June . . . . .	0·35	noon	1 a.m.	5	19
July . . . . .	0·24	11 a.m. and 3 p.m.	7 and 8 p.m.	5	33
August . . . . .	0·46	1 p.m.	2 a.m. and 6 p.m.	10	39
September . . . . .	0·39	1, 5 and 6 p.m.	7, 8, 11 a.m. and noon	6	40
October . . . . .	—	—	—	16	44
November . . . . .	0·36	—	—	8	66
December . . . . .	0·25	—	—	6	130



The second and third columns give the hours at which the highest and lowest mean temperatures occurred. The fourth column shows the equivalent of the temperature range in the first column, in terms of the correction to  $V$ ; for comparison with this, the fifth column gives the range of the corrected  $V$  diurnal inequality. To illustrate the table, take the case of December, 1902. The Vertical-Force magnet had its highest temperature at 3 p.m., its lowest at 4 a.m., the difference between the two being  $4^{\circ} \cdot 16$  C. The correction to the apparent value of  $V$  necessary to eliminate the effects of temperature was greater at 3 p.m. than at 4 a.m. to the extent of  $145\gamma$ , or about  $2 \cdot 8$  times the total range obtained for  $V$  after applying the correction.

In the Midwinter months the temperature range was small, and the hours of highest and lowest temperature varied much from month to month. Thus, the  $V$ -inequality results for the Midwinter months, and especially that for the whole season, should be but little influenced by temperature uncertainties. Subsequent to March, 1903, the regular diurnal variations of temperature in the Magnetic Hut were small. It is thus satisfactory that the inequalities finally deduced from the 1902 and 1903 curves agree in type.

## CHAPTER III.

## DIURNAL INEQUALITIES.

§20. The questions of secular change and annual inequality have been treated out of their natural order because they appeared so closely connected with instrumental questions that it was desirable to discuss them in that connection. Before passing to the diurnal inequalities, it will be convenient to deal with some points relating to the measurement of the curves and the construction of the tables of observational data (pp. 8-70). After examining the curves, I came to the conclusion that if the value assigned to a particular element at a definite hour were derived as usual from a single measurement of the curve ordinate at the exact hour, the irregularities arising from "accidental" disturbances would probably conceal the regular diurnal inequality altogether, or at least in great measure. To meet this difficulty, it is customary at some places to smooth curves by drawing a pencil trace, giving the general trend, as distinguished from "accidental" irregularities. An alternative plan, which has been sometimes suggested, is to determine mean ordinates for successive hourly intervals of time by planimeter measurements. Owing to the excessively disturbed character of the Antarctic Declination and Horizontal-Force curves, neither of these alternatives appeared feasible. Eventually I decided not to smooth the curves in any way, but to take as the ordinate at any hour the arithmetic mean of three ordinates, one exactly at the hour, the others at 20 minutes before and after. This necessitated the measurement of the curves at 20-minute intervals throughout the day. A suitable glass scale was constructed by Mr. FOSTER, one of the senior assistants in the Observatory Department. The ordinates on the scale were divided at millimetre intervals and, when reading, 0.1 mm. was usually aimed at, though this degree of accuracy is not claimed in the results. Readings were in all, or nearly all, cases repeated, usually by a different observer, and in the event of serious discrepancy a third measurement was made. Owing to the time occupied in changing papers, it was a frequent occurrence for one of the 20-minute readings to be lost, and, at some seasons, intervals exceeding 20 minutes were not unusual. The way of dealing with these gaps varied according to circumstances. Supposing, for instance, the reading at an exact hour missing, the value assigned to that hour was usually the mean from the readings at 20 minutes before and after; but if a gap commenced or ended within a few minutes of an exact hour, the readings taken 20 minutes before and after the hour might be combined with an interpolated value, intended to represent the missing reading. The precise procedure to be adopted was determined by myself with the curves before me. In the case more particularly of the Horizontal Force, the limits of registration were exceeded rather frequently, especially in Summer. If this happened at, say, 20 minutes before the hour, the curve coming on the sheet at, say, 10 minutes to the hour and continuing on for some time, the value given in the table of hourly values was the mean from three readings which corresponded to the exact hour and to 10 minutes before and after. If, however, a limit of registration were exceeded for an appreciable time at the exact hour, the entry in the tables normally indicated an excess of the limit, precisely as it would have done if the limit had been exceeded not merely at the hour but at 20 minutes before and after as well.

§21. In the case of the Declination, measurements were always taken to 0.1 mm.—answering to 0.15—but decimals are discarded in the hourly values in the tables as not really warranted by the accuracy attainable. In the case, however, of the diurnal inequalities (pp. 90-99), the data being means from a number of readings are given to the nearest 0.1.

In the Horizontal-Force tables hourly values are given to 1 $\gamma$ , and diurnal-inequality data (pp. 94 and 95) to 0.1 $\gamma$ . This degree of accuracy was fairly warranted, so far as mere uncertainties of reading are concerned, owing to the very open scale. It is, however, I freely admit, open to criticism on the ground that no temperature correction has been applied. What the exact degree of uncertainty on this ground may be it is difficult to say. None of the suspensions used in the Antarctic survived, and no inference seemed capable of being drawn by application of the method employed in the case of the Vertical Force. All that inspection showed was that the temperature coefficient was small, its sign even not being disclosed. Even if it had been large, the continually disturbed state of the Horizontal Force would have rendered any high accuracy in its determination impossible. We know that the rigidity of the quartz suspension

would rise with increase of temperature, while the magnetic moment of the magnet would naturally diminish; thus, presumably, the correction required was positive when temperature was above its mean.

At Kew, quartz suspensions used in the Watson type of magnetograph have had temperature coefficients of from  $3\gamma$  to  $6\gamma$  per  $1^\circ$  C. But in the Antarctic the Horizontal Force was only about a third of that at Kew, so that correspondingly less torsion was put into the suspension, and the presumption, accordingly, is that the temperature coefficient was considerably lower than those found at Kew. The absence of a temperature correction may appreciably influence the diurnal inequality in two or three of the Midsummer months. At other seasons its influence is hardly likely to be of any importance, except in the case of individual hourly readings on days of large temperature change.

In the Vertical-Force tables the hourly values are given only to the nearest  $10\gamma$ , but the absolute maximum and minimum are given to the nearest  $1\gamma$ . The reasons for this are as follows:—Owing to dislocations in both the Vertical-Force and the temperature traces there were at times somewhat large uncertainties as to the relative values of the base line at different parts of the same month. It was thus felt that the retention of five significant figures in hourly values represented far more than the accuracy attainable. There was also the consideration that the scale was very contracted in most months, and the further consideration that readings to the nearest  $10\gamma$  sufficed to give diurnal-inequality data, going to  $1\gamma$ . When the Vertical-Force curves were first tabulated it seemed unlikely that anything beyond diurnal inequalities would be attempted. In fact, it was not until the absolute ranges in Declination and Horizontal Force had been analysed that it was decided to attempt to obtain corresponding data for the Vertical Force. It was obvious, however, that in most cases accuracy to nearer than  $10\gamma$  was obtainable in the ranges—because the uncertainties attending absolute values of the base line largely disappear when considering *differences* of readings taken on the same day—and accordingly it was decided to retain five significant figures in the values of the daily maximum and minimum. It was often exceedingly difficult to say which of several very nearly equal ordinates (allowance being made for temperature) represented the true maximum or minimum. The times of occurrence were not measured very exactly.

§22. Before dealing with the data obtained for the diurnal inequalities reference must be made to one source of uncertainty to which attention has already been drawn by Commander CHETWYND (“Physical Observations,” p. 134). Winter Quarters was a station at which there was appreciable local magnetic disturbance. Observations made on the ice in McMurdo Sound, about  $1\frac{1}{2}$  miles from the Magnetic Huts (*see* Frontispiece), gave for the Horizontal Force a value of  $\cdot 0433$  C.G.S., or only about two-thirds of that found at Winter Quarters. The differences in the other elements were much less. The Declination at the Ice Station was about  $5^\circ$  less and the Inclination  $1\frac{1}{2}^\circ$  greater than at Winter Quarters. As the Ice Station was in fairly deep water, the presumption is that these differences represent local disturbance at Winter Quarters. To the question what the effect of such local disturbances is on diurnal inequalities one cannot give a positive answer. If we suppose diurnal inequalities to be due to overhead electric currents, as Dr. SCHUSTER’S mathematical calculations indicate, and as is most generally supposed, and if no sensible diurnal variation is caused by solar radiation or similar cause in the local disturbing field, then the presence of the local disturbance will influence only the Declination diurnal inequality, the amplitude of which will vary inversely as the value of the Horizontal Force. If this view is correct, then the only effect of the local disturbance at Winter Quarters would be to reduce the amplitude of all Declination changes in the ratio approximately of 2 : 3. It must be admitted that there is little, if any, positive evidence of the correctness of the view. There is some evidence, on the contrary, that in highly disturbed regions the effect on the diurnal inequality is much more complicated. But the local disturbance at Winter Quarters was not really large. An increase of 50 per cent. in the Horizontal Force is not, of course, small from one point of view, but an increase of  $\cdot 02$  C.G.S. does not mean anything very much out of the way at a place where the total force exceeded  $\cdot 7$  C.G.S. If the source of the disturbance were basaltic rock close to the surface—as seems most probable from the description of the station—there would not appear to be much reason to fear anything more than a reduction in the Declination range. Under such circumstances, no doubt, direct heating by the sun would have some effect at Midsummer, but it could hardly be large. Even at the surface the range of the regular diurnal inequality of temperature, when largest, was only about  $4^\circ$  F.

§23. Tables XII to XXII (pp. 90 to 99) give the results obtained for the diurnal inequalities. In the case of the Declination two sets of results are given, the one derived from all days available, the other from the quieter only of these days. Table XII gives the all-days' Declination results for individual months. Table XIII gives the corresponding results for the twelve months of the year, taking a mean from 1902 and 1903 in cases when data from both years were available; it also gives diurnal inequalities for the year as a whole and for three seasons, Midwinter (May to July), Equinox (March, April, September, and October), and Midsummer (November to January). Tables XIV and XV give corresponding results from the quieter days. For November, 1902, an additional inequality is added in Table XIV which excludes only the five most highly disturbed days, and so is intermediate between the inequalities based on "all" and on "quieter" days. Midwinter was limited to three months, so as to include only days throughout the whole of which the sun was below the horizon; in Midsummer, on the other hand, the sun never set. The Horizontal Force and Vertical-Force data were treated similarly to the Declination, except that no quieter days' inequalities were formed. Tables XVI and XVII relate to the Horizontal Force, Tables XVIII and XIX to the Vertical Force. In the case of the Inclination, inequalities have to be calculated from the corresponding Horizontal-Force and Vertical-Force inequalities. It appeared sufficient to give a single table, Table XX, containing results for the twelve months of the year, and the three seasons, employing data from both 1902 and 1903 when available. Tables XXI and XXII give the diurnal inequalities of the components of the Horizontal Force, respectively in and perpendicular to the astronomical Meridian; results are given only for the three seasons and the year. These were calculated from the corresponding inequalities  $\Delta D$  and  $\Delta H$  in Declination and Horizontal Force by means of the formulæ

$$\Delta S = \cos \phi \Delta H + \sin \phi \Delta D, \quad \Delta W = \cos \phi \Delta D - \sin \phi \Delta H,$$

where  $\phi$  is the supplement of the easterly Declination, and  $\Delta$  denotes the departure at any given hour from the mean value of the day. The mean values accepted for  $\phi$  and for  $H$ , and the force equivalent to  $1'$  in Declination, were as follows:—

	Midwinter.	Equinox.	Midsummer.	Year.
$\phi$ . . . . .	27° 23'	27° 12'	27° 13'	27° 17'
$H$ . . . . .	·06650	·06606	·06469	·06573
Equivalent of $1'$ in $D$ . . . . .	1·93 $\gamma$	1·92 $\gamma$	1·88 $\gamma$	1·91 $\gamma$

The working equations thence actually deduced,  $\Delta H$ ,  $\Delta S$ , and  $\Delta W$ , being measured in terms of  $1\gamma$  as unit, and  $\Delta D$  in terms of  $1'$ , were as follows:—

	Midwinter.	Equinox.	Midsummer.	Year.
$\Delta S =$ . . . . .	0·89 ( $\Delta H + \Delta D$ )	0·89 $\Delta H + 0·88 \Delta D$	0·89 $\Delta H + 0·86 \Delta D$	0·89 $\Delta H + 0·88 \Delta D$
$\Delta W =$ . . . . .	-0·46 $\Delta H + 1·71 \Delta D$	-0·46 $\Delta H + 1·71 \Delta D$	-0·46 $\Delta H + 1·67 \Delta D$	-0·46 $\Delta H + 1·70 \Delta D$

§24. In all the diurnal inequality tables the algebraically largest and least of the hourly values are in heavy type. The tables also contain the ranges as derived from the largest and least of the hourly readings, and the sum of the 24-hourly differences from the mean for the day.

In calculating the diurnal inequalities use was made in general only of days in which the record was complete from midnight to midnight. In some months, where the number of days of complete record was small, hourly values were interpolated when a gap of only an hour or two occurred in the record during a relatively quiet day. In some cases where material was scanty, use was made of periods of 24 successive hours which commenced at hours other than local midnight. This happened, for instance, with the Vertical Force in November and December, 1903. In the latter month the record extended from 2 p.m. on the 12th to 1 p.m. on the 16th, and by making the day start at 2 p.m. four complete days' record were obtained.

Particulars of the days employed for the various inequalities are given in the table on pp. 71 and 72.

TABLE XII.—Declination. "All Days" Diurnal Inequality.

	Forenoon.												Afternoon.												Range.	Sum of 24 differences from the mean.
	1.	2.	3.	4.	5.	6.	7.	8.	9.	10.	11.	12.	1.	2.	3.	4.	5.	6.	7.	8.	9.	10.	11.	12.		
1902																										
March . . . .	+0.5	+0.7	+2.4	+7.7	+10.8	+10.4	+11.7	+15.0	+15.3	+18.1	+11.4	+6.0	-3.4	-13.5	-12.9	-15.5	-10.6	-11.7	-12.1	-11.2	-8.8	-5.5	-3.7	-1.9	33.6	220.8
April . . . .	-1.4	+0.6	+3.7	+3.8	+7.6	+10.8	+11.7	+15.2	+17.0	+14.6	+11.1	+5.1	-0.4	-6.8	-9.7	-11.1	-12.0	-10.8	-13.1	-10.3	-9.1	-8.8	-4.7	-2.8	30.1	202.2
May . . . .	0.0	+1.6	+2.9	+8.1	+9.6	+8.2	+5.9	+6.9	+7.0	+7.1	+5.7	+4.5	+2.1	-1.4	-4.9	-8.1	-9.9	-10.0	-10.6	-10.7	-6.4	-4.1	-2.2	-0.5	20.4	138.6
June . . . .	+0.5	+0.5	+2.2	+3.8	+4.2	+3.8	+6.8	+7.0	+6.9	+7.7	+7.0	+5.1	+3.9	+1.8	-1.3	-3.6	-6.1	-9.9	-12.1	-10.7	-8.9	-5.2	-2.9	-0.6	19.8	122.5
July . . . .	+0.9	+2.4	+2.8	+1.6	+3.1	+5.1	+5.4	+5.4	+6.7	+8.6	+8.2	+7.7	+4.5	+2.0	-1.1	-7.1	-10.9	-10.7	-11.3	-11.1	-7.9	-4.5	-1.0	+1.5	19.9	131.5
August . . . .	+1.8	+1.4	+3.0	+3.7	+5.0	+5.4	+8.4	+10.6	+9.6	+9.0	+8.7	+3.8	+0.5	-2.8	-6.4	-7.9	-8.5	-7.8	-10.6	-11.1	-8.8	-4.4	-1.5	-0.8	21.7	141.5
September . . . .	0.0	+1.1	+4.3	+8.8	+13.1	+17.7	+17.4	+19.0	+19.0	+13.2	+8.9	+3.6	+0.1	-5.5	-9.1	-14.5	-18.5	-18.6	-17.8	-15.2	-10.6	-7.7	-5.9	-1.6	37.6	251.2
October . . . .	+3.5	+6.5	+8.9	+8.8	+13.3	+15.7	+16.1	+18.7	+20.0	+14.5	+12.6	+8.6	-1.4	-5.8	-16.3	-20.8	-23.4	-25.5	-20.0	-17.4	-12.0	-6.3	-0.6	+2.4	45.5	299.1
November . . . .	+3.8	+7.3	+10.8	+16.3	+10.9	+11.2	+15.6	+32.9	+28.4	+24.3	+9.6	+4.4	-1.9	-7.6	-17.1	-22.6	-22.8	-27.2	-27.0	-16.1	-16.2	-10.1	-8.4	+1.9	60.1	354.4
December . . . .	-9.2	+1.7	+4.7	+11.4	+20.6	+22.4	+29.9	+46.2	+51.6	+42.7	+20.3	+14.4	+3.4	-8.0	-23.3	-28.5	-33.6	-31.2	-30.7	-28.9	-25.8	-22.7	-17.3	-9.9	85.2	538.4
1903																										
January . . . .	-9.1	-0.7	+0.2	+13.4	+13.3	+28.6	+22.5	+20.4	+26.0	+24.2	+22.6	+11.3	+7.7	+0.9	-6.9	-15.6	-21.0	-24.3	-28.6	-30.0	-22.7	-13.7	-14.2	-4.5	58.6	382.4
February . . . .	-7.0	+0.4	+5.5	+6.6	+14.6	+13.2	+22.1	+30.1	+37.5	+36.0	+25.6	+21.7	+12.1	-1.9	-9.9	-23.0	-30.0	-32.1	-31.8	-27.9	-23.1	-19.0	-11.6	-8.2	69.6	450.9
March . . . .	-2.5	+0.2	+4.8	+8.3	+13.4	+19.8	+22.8	+24.4	+25.0	+22.9	+16.9	+10.2	-0.1	-9.9	-16.4	-18.8	-21.3	-22.1	-22.4	-18.9	-15.1	-9.6	-6.8	-3.8	47.4	336.4
April . . . .	+1.1	+1.9	+7.4	+10.5	+13.6	+15.9	+14.6	+16.8	+19.2	+18.9	+15.0	+8.4	+2.9	-3.8	-9.8	-13.5	-15.5	-19.5	-21.5	-20.7	-16.6	-11.6	-7.7	-6.6	40.7	293.0
May . . . .	+0.9	+1.0	+3.2	+4.3	+7.7	+11.6	+15.2	+14.5	+18.1	+13.6	+14.2	+7.0	+4.4	-0.5	-4.9	-11.6	-12.8	-19.5	-17.8	-14.4	-13.6	-12.0	-4.6	-3.4	37.6	230.8
June . . . .	-1.8	-1.2	+4.4	+10.4	+11.8	+11.9	+17.8	+16.2	+14.7	+16.0	+12.7	+10.2	+5.2	+1.5	-5.4	-12.3	-16.4	-18.4	-17.7	-21.0	-14.9	-11.5	-7.7	-4.7	38.8	265.8
July . . . .	-0.3	+3.8	+4.8	+11.2	+12.9	+14.3	+10.4	+14.2	+14.4	+16.8	+13.8	+12.3	+2.8	+2.3	-5.4	-11.6	-14.9	-22.1	-21.8	-18.8	-15.2	-14.1	-6.2	-2.9	38.9	267.3
August . . . .	-3.2	+2.5	+3.1	+8.6	+11.6	+16.5	+17.8	+23.8	+21.4	+20.6	+19.0	+12.3	+6.2	-5.3	-9.2	-11.7	-17.5	-19.0	-21.6	-26.0	-20.9	-12.5	-11.6	-5.3	49.8	327.2
September . . . .	-4.7	+4.9	+12.6	+21.1	+20.2	+23.9	+22.6	+21.9	+31.7	+33.4	+28.5	+15.1	+5.8	-6.9	-20.0	-26.9	-30.6	-35.9	-32.3	-27.7	-22.2	-19.0	-7.6	-8.5	69.3	484.0

TABLE XIII.—Declination. "All Days" Diurnal Inequality.

	Forenoon.												Afternoon.												Range.	Sum of 24 differences from the mean.
	1.	2.	3.	4.	5.	6.	7.	8.	9.	10.	11.	12.	1.	2.	3.	4.	5.	6.	7.	8.	9.	10.	11.	12.		
January . . .	-9.1	-0.7	+0.2	+13.4	+13.3	+28.6	+22.5	+20.4	+26.0	+24.2	+22.6	+11.3	+7.7	+0.9	-6.9	-15.6	-21.0	-24.3	-28.6	-30.0	-22.7	-13.7	-14.2	-4.5	58.6	382.4
February . . .	-7.0	+0.4	+5.5	+6.6	+14.6	+13.2	+22.1	+30.1	+37.5	+36.0	+25.6	+21.7	+12.1	-1.9	-9.9	-23.0	-30.0	-32.1	-31.8	-27.9	-23.1	-19.0	-11.6	-8.2	69.6	450.9
March . . . .	-2.5	+0.2	+4.8	+8.3	+13.4	+19.8	+22.8	+24.4	+25.0	+22.9	+16.9	+10.2	-0.1	-9.9	-16.4	-18.8	-21.3	-22.1	-22.4	-18.9	-15.1	-9.6	-6.8	-3.8	47.4	336.4
April . . . .	-0.2	+1.3	+5.5	+7.2	+10.6	+13.3	+13.2	+16.0	+18.1	+16.7	+13.1	+6.7	+1.3	-5.3	-9.8	-12.3	-13.7	-15.2	-17.3	-15.5	-12.8	-10.2	-6.2	-4.7	35.4	246.2
May . . . . .	+0.4	+1.3	+3.1	+6.2	+8.6	+9.9	+10.5	+10.7	+12.6	+10.4	+9.9	+5.8	+3.2	-1.0	-4.9	-9.8	-11.4	-14.7	-14.3	-12.6	-10.0	-8.0	-3.4	-1.9	27.3	184.6
June . . . . .	-0.7	-0.3	+3.3	+7.1	+8.0	+7.9	+12.3	+11.6	+10.8	+11.8	+9.9	+7.6	+4.6	+1.6	-3.3	-8.0	-11.2	-14.2	-14.9	-15.8	-11.9	-8.4	-5.3	-2.6	28.1	193.1
July . . . . .	+0.3	+3.1	+3.8	+6.4	+8.0	+9.7	+7.9	+9.8	+10.6	+12.7	+11.0	+10.0	+3.7	+2.1	-3.2	-9.4	-12.9	-16.4	-16.5	-15.0	-11.5	-9.3	-3.6	-0.7	29.2	197.6
August . . . .	-0.7	+1.9	+3.1	+6.2	+8.3	+10.9	+13.1	+17.2	+15.5	+14.8	+13.9	+8.0	+3.4	-4.0	-7.8	-9.8	-13.0	-13.4	-16.1	-18.6	-14.8	-8.5	-6.5	-3.1	35.8	232.6
September . .	-2.4	+3.0	+8.5	+14.9	+16.7	+20.8	+20.0	+20.5	+25.3	+23.3	+18.7	+9.4	+2.9	-6.2	-14.6	-20.7	-24.5	-27.3	-25.0	-21.5	-16.4	-13.3	-6.8	-5.0	52.6	367.7
October . . .	+3.5	+6.5	+8.9	+8.8	+13.3	+15.7	+16.1	+18.7	+20.0	+14.5	+12.6	+8.6	-1.4	-5.8	-16.3	-20.8	-23.4	-25.5	-20.0	-17.4	-12.0	-6.3	-0.6	+2.4	45.5	299.1
November . .	+3.8	+7.3	+10.8	+16.3	+10.9	+11.2	+15.6	+32.9	+28.4	+24.3	+9.6	+4.4	-1.9	-7.6	-17.1	-22.6	-22.8	-27.2	-27.0	-16.1	-16.2	-10.1	-8.4	+1.9	60.1	354.4
December . .	-9.2	+1.7	+4.7	+11.4	+20.6	+22.4	+29.9	+46.2	+51.6	+42.7	+20.3	+14.4	+3.4	-8.0	-23.3	-28.5	-33.6	-31.2	-30.7	-28.9	-25.8	-22.7	-17.3	-9.9	85.2	538.4
Year . . . . .	-2.0	+2.1	+5.2	+9.4	+12.2	+15.3	+17.2	+21.5	+23.5	+21.2	+15.3	+9.8	+3.2	-3.8	-11.1	-16.6	-19.9	-22.0	-22.0	-19.9	-16.0	-11.6	-7.6	-3.3	45.5	311.7
Midwinter . .	0.0	+1.4	+3.4	+6.6	+8.2	+9.2	+10.2	+10.7	+11.3	+11.6	+10.3	+7.8	+3.8	+0.9	-3.8	-9.1	-11.8	-15.1	-15.2	-14.5	-11.1	-8.6	-4.1	-1.7	26.8	190.4
Equinox . . .	-0.4	+2.7	+6.9	+9.8	+13.5	+17.4	+18.0	+19.9	+22.1	+19.4	+15.3	+8.7	+0.7	-6.8	-14.3	-18.1	-20.7	-22.5	-21.2	-18.3	-14.1	-9.8	-5.1	-2.8	44.6	308.5
Midsummer . .	-4.8	+2.8	+5.2	+13.7	+14.9	+20.7	+22.7	+33.2	+35.3	+30.4	+17.5	+10.0	+3.1	-4.9	-15.8	-22.2	-25.8	-27.6	-28.8	-25.0	-21.6	-15.5	-13.3	-4.2	64.1	419.0

N 2

DIURNAL INEQUALITIES.

TABLE XIV.—Declination. "Quieter Days" Diurnal Inequality.

	Forenoon.												Afternoon.												Range.	Sum of 24 differences from the mean.
	1.	2.	3.	4.	5.	6.	7.	8.	9.	10.	11.	12.	1.	2.	3.	4.	5.	6.	7.	8.	9.	10.	11.	12.		
1902	/	/	/	/	/	/	/	/	/	/	/	/	/	/	/	/	/	/	/	/	/	/	/	/	/	/
April . . . . .	- 1.8	- 1.5	+ 2.6	+ 2.5	+ 4.6	+ 5.9	+ 7.9	+11.6	+14.8	+15.3	+ 9.2	+ 2.2	-1.4	- 7.3	- 8.1	- 9.5	- 9.3	- 7.4	- 7.5	- 6.5	- 6.9	- 5.4	- 2.6	- 1.8	24.8	153.6
May . . . . .	- 0.2	+ 1.4	+ 2.2	+ 3.0	+ 4.3	+ 4.6	+ 5.8	+ 5.5	+ 4.7	+ 5.3	+ 3.4	+ 2.6	+2.3	- 1.9	- 3.9	- 4.9	- 4.8	- 5.3	- 5.4	- 7.6	- 5.1	- 3.1	- 2.0	- 0.8	13.4	90.1
June . . . . .	+ 0.7	- 0.7	+ 1.4	+ 0.7	+ 1.5	+ 2.1	+ 3.3	+ 3.2	+ 4.8	+ 3.4	+ 2.6	+ 1.3	+1.1	+ 0.1	- 1.2	- 2.4	- 3.9	- 5.0	- 3.1	- 3.7	- 3.2	- 2.4	- 1.0	+ 0.2	9.8	52.0
July . . . . .	+ 0.8	+ 1.2	+ 2.3	+ 1.1	+ 2.5	+ 4.1	+ 3.9	+ 4.6	+ 5.1	+ 4.8	+ 3.5	+ 3.4	+1.5	0.0	- 2.0	- 3.9	- 5.2	- 7.7	- 6.7	- 6.3	- 4.9	- 2.9	+ 0.4	+ 1.1	12.8	79.9
August . . . . .	+ 0.7	+ 1.6	+ 2.3	+ 2.6	+ 3.9	+ 4.4	+ 5.4	+ 6.7	+ 4.8	+ 5.5	+ 4.4	+ 1.3	-1.8	- 3.1	- 4.0	- 4.7	- 4.7	- 4.5	- 5.5	- 5.4	- 5.0	- 3.9	- 1.7	- 0.2	12.2	88.1
September . . . . .	+ 0.9	+ 2.2	+ 5.0	+ 6.6	+ 9.6	+13.0	+12.9	+13.8	+13.4	+10.3	+ 5.3	+ 2.2	-2.9	- 7.5	- 8.6	-11.9	-14.2	-14.4	-11.6	- 9.3	- 7.2	- 5.0	- 2.8	- 0.3	28.2	90.9
October . . . . .	+ 8.3	+11.0	+10.5	+ 9.1	+11.4	+10.4	+ 9.1	+10.5	+10.8	+ 6.0	+ 2.4	+ 2.7	-2.6	- 8.6	-13.2	-15.4	-17.3	-18.5	-14.3	-11.3	- 6.5	- 2.3	+ 1.7	+ 7.3	29.9	221.2
November . . . . .	+ 3.5	+ 3.3	+ 2.3	+ 8.4	+ 1.2	+12.6	+26.9	+29.0	+28.9	+21.9	+ 6.4	+ 0.9	-1.9	-14.5	-20.6	-22.0	-19.8	-18.7	-18.0	-14.5	- 8.3	- 6.3	- 2.3	+ 1.2	51.0	293.4
December . . . . .	- 5.0	+ 1.6	+ 9.4	+14.5	+22.6	+26.5	+32.1	+38.2	+40.6	+27.4	+ 4.3	+ 2.1	-5.5	-11.8	-23.2	-24.3	-28.1	-22.6	-28.2	-22.2	-17.1	-13.6	-10.2	- 6.5	68.8	437.6
1903	/	/	/	/	/	/	/	/	/	/	/	/	/	/	/	/	/	/	/	/	/	/	/	/	/	/
January . . . . .	-12.3	- 3.7	+ 3.2	+ 5.9	+13.4	+24.0	+24.0	+33.0	+39.5	+37.4	+26.6	+12.4	+2.0	- 8.4	-11.5	-19.1	-19.3	-26.4	-31.1	-31.5	-20.0	-13.8	-13.5	-10.1	71.0	442.1
February . . . . .	- 3.6	+ 2.7	+ 7.1	+12.6	+14.8	+ 9.2	+19.6	+25.1	+25.9	+28.4	+17.9	+16.4	+8.6	- 4.2	- 6.3	-19.3	-24.3	-25.6	-27.2	-27.6	-20.5	-14.6	- 7.5	- 7.3	56.0	376.3
March . . . . .	- 2.0	+ 1.0	+ 3.3	+ 4.2	+ 9.6	+15.8	+18.7	+21.2	+16.8	+14.8	+11.5	+ 1.9	-0.6	- 6.2	-11.2	-14.8	-16.9	-17.2	-15.9	-14.5	- 8.9	- 4.4	- 3.1	- 2.1	38.4	236.6
April . . . . .	- 0.6	- 1.3	+ 2.0	+ 3.5	+ 5.1	+ 7.9	+10.5	+12.9	+17.2	+18.1	+11.9	+ 4.9	+0.4	- 6.5	- 8.4	-10.0	-13.5	-14.8	-14.3	-10.3	- 7.8	- 3.5	- 1.7	- 1.0	32.9	188.1
May . . . . .	+ 0.4	+ 0.1	+ 1.7	+ 3.3	+ 6.7	+ 7.8	+13.3	+13.5	+10.8	+ 8.4	+ 6.9	+ 3.6	-0.4	- 3.6	- 3.5	- 7.6	-10.5	-12.0	-11.5	-10.4	- 7.7	- 5.4	- 2.4	- 1.3	25.5	152.8
June . . . . .	+ 1.7	+ 3.0	+ 1.0	+ 2.7	+ 5.8	+ 5.3	+ 4.7	+ 2.9	+ 5.2	+ 5.0	+ 3.0	+ 2.8	-0.2	- 0.5	- 1.0	- 3.1	- 4.6	- 6.2	- 4.1	- 6.0	- 5.6	- 6.1	- 4.5	- 0.8	12.0	85.8
July . . . . .	- 0.4	+ 1.9	+ 2.4	+ 5.0	+ 5.8	+ 7.0	+ 6.5	+ 6.9	+ 7.6	+ 8.2	+ 7.6	+ 5.6	+2.5	+ 2.7	- 2.5	- 6.0	- 9.0	- 9.6	-10.9	-12.4	-10.4	- 5.3	- 3.0	- 0.3	20.6	139.5
August . . . . .	+ 1.1	+ 3.1	+ 3.9	+ 5.3	+ 6.2	+ 8.3	+10.6	+ 8.5	+ 5.7	+ 7.0	+ 6.9	+ 3.6	+0.8	- 2.6	- 2.9	- 6.5	- 7.6	-11.7	-10.5	-10.6	-10.3	- 4.9	- 4.0	+ 1.1	22.3	143.7
September . . . . .	- 2.8	+ 0.7	+10.8	+17.6	+13.4	+12.7	+14.3	+ 9.9	+15.6	+17.1	+17.0	+11.4	+0.3	- 3.0	- 9.5	- 9.6	-11.5	-15.8	-21.7	-20.6	-17.5	-14.8	- 6.6	- 6.8	39.3	281.0
November 1902 all less 5 days	+ 4.5	+ 3.7	+ 5.6	+10.0	+ 8.8	+15.7	+25.8	+32.7	+25.1	+22.5	+ 8.1	- 0.5	+0.8	- 9.2	-17.5	-23.4	-23.2	-26.8	-24.2	-17.0	-11.2	- 6.1	- 4.3	+ 0.8	59.5	327.5

DIURNAL INEQUALITIES.

TABLE XV.—Declination. "Quieter Days" Diurnal Inequality.

	Forenoon.												Afternoon.												Range.	Sum of 24 differences from the mean.
	1.	2.	3.	4.	5.	6.	7.	8.	9.	10.	11.	12.	1.	2.	3.	4.	5.	6.	7.	8.	9.	10.	11.	12.		
January . . .	-12.3	- 3.7	+ 3.2	+ 5.9	+13.4	+24.0	+24.0	+33.0	+39.5	+37.4	+26.6	+12.4	+ 2.0	- 8.4	-11.5	-19.1	-19.3	-26.4	-31.1	-31.5	-20.0	-13.8	-13.5	-10.1	71.0	442.1
February . . .	- 3.6	+ 2.7	+ 7.1	+12.6	+14.8	+ 9.2	+19.6	+25.1	+25.9	+28.4	+17.9	+16.4	+ 8.6	- 4.2	- 6.3	-19.3	-24.3	-25.6	-27.2	-27.6	-20.5	-14.6	- 7.5	- 7.3	56.0	376.3
March . . . .	- 2.0	+ 1.0	+ 3.3	+ 4.2	+ 9.6	+15.8	+18.7	+21.2	+16.8	+14.8	+11.5	+ 1.9	- 0.6	- 6.2	-11.2	-14.8	-16.9	-17.2	-15.9	-14.5	- 8.9	- 4.4	- 3.1	- 2.1	38.4	236.6
April . . . . .	- 1.2	- 1.4	+ 2.3	+ 3.0	+ 4.8	+ 6.9	+ 9.2	+12.3	+16.0	+16.7	+10.5	+ 3.6	- 0.5	- 6.9	- 8.3	- 9.7	-11.4	-11.1	-10.9	- 8.4	- 7.3	- 4.5	- 2.1	- 1.4	28.1	170.4
May . . . . .	+ 0.1	+ 0.8	+ 1.9	+ 3.2	+ 5.5	+ 6.2	+ 9.5	+ 9.5	+ 7.8	+ 6.8	+ 5.2	+ 3.1	+ 0.9	- 2.7	- 3.7	- 6.2	- 7.7	- 8.6	- 8.5	- 9.0	- 6.4	- 4.3	- 2.2	- 1.0	18.5	120.3
June . . . . .	+ 1.2	+ 1.2	+ 1.2	+ 1.7	+ 3.6	+ 3.7	+ 4.0	+ 3.1	+ 5.0	+ 4.2	+ 2.8	+ 2.0	+ 0.5	- 0.2	- 1.1	- 2.7	- 4.3	- 5.6	- 3.6	- 4.3	- 4.4	- 4.3	- 2.7	- 0.3	10.6	67.7
July . . . . .	+ 0.2	+ 1.5	+ 2.4	+ 3.1	+ 4.1	+ 5.5	+ 5.2	+ 5.8	+ 6.3	+ 6.5	+ 5.6	+ 4.5	+ 2.0	+ 1.3	- 2.2	- 4.9	- 7.1	- 8.6	- 8.8	- 9.4	- 7.6	- 4.1	- 1.3	+ 0.4	15.9	108.4
August . . . .	+ 0.9	+ 2.3	+ 3.1	+ 4.0	+ 5.0	+ 6.4	+ 8.0	+ 7.6	+ 5.3	+ 6.2	+ 5.7	+ 2.5	- 0.5	- 2.9	- 3.5	- 5.6	- 6.1	- 8.1	- 8.0	- 8.0	- 7.6	- 4.4	- 2.8	+ 0.4	16.1	114.9
September . .	- 1.0	+ 1.5	+ 7.9	+12.1	+11.5	+12.8	+13.6	+11.9	+14.5	+13.7	+11.1	+ 6.8	- 1.3	- 5.2	- 9.1	-10.8	-12.8	-15.1	-16.7	-14.9	-12.4	- 9.9	- 4.7	- 3.5	31.2	234.8
October . . . .	+ 8.3	+11.0	+10.5	+ 9.1	+11.4	+10.4	+ 9.1	+10.5	+10.8	+ 6.0	+ 2.4	+ 2.7	- 2.6	- 8.6	-13.2	-15.4	-17.3	-18.5	-14.3	-11.3	- 6.5	- 2.3	+ 1.7	+ 7.3	29.9	221.2
November . . .	+ 3.5	+ 3.3	+ 2.3	+ 8.4	+ 1.2	+12.6	+26.9	+29.0	+28.9	+21.9	+ 6.4	+ 0.9	- 1.9	-14.5	-20.6	-22.0	-19.8	-18.7	-18.0	-14.5	- 8.3	- 6.3	- 2.3	+ 1.2	51.0	293.4
December . . .	- 5.0	+ 1.6	+ 9.4	+14.5	+22.6	+26.5	+32.1	+38.2	+40.6	+27.4	+ 4.3	+ 2.1	- 5.5	-11.8	-23.2	-24.3	-28.1	-22.6	-28.2	-22.2	-17.1	-13.6	-10.2	- 6.5	68.8	437.6
Year . . . . .	- 0.9	+ 1.8	+ 4.5	+ 6.8	+ 9.0	+11.7	+15.0	+17.3	+18.1	+15.8	+ 9.2	+ 4.9	+ 0.1	- 5.9	- 9.5	-12.9	-14.6	-15.5	-15.9	-14.6	-10.6	- 7.2	- 4.2	- 1.9	34.0	227.9
Midwinter . . .	+ 0.5	+ 1.2	+ 1.8	+ 2.7	+ 4.4	+ 5.1	+ 6.2	+ 6.1	+ 6.4	+ 5.8	+ 4.5	+ 3.2	+ 1.1	- 0.5	- 2.3	- 4.6	- 6.4	- 7.6	- 7.0	- 7.6	- 6.1	- 4.2	- 2.1	- 0.3	14.0	97.7
Equinox . . . .	+ 1.0	+ 3.0	+ 6.0	+ 7.1	+ 9.3	+11.5	+12.6	+14.0	+14.5	+12.8	+ 8.9	+ 3.8	- 1.2	- 6.7	-10.4	-12.7	-14.6	-15.5	-14.5	-12.3	- 8.8	- 5.3	- 2.0	+ 0.1	30.0	208.6
Midsummer . .	- 4.6	+ 0.4	+ 5.0	+ 9.6	+12.4	+21.0	+27.7	+33.4	+36.4	+28.9	+12.4	+ 5.1	- 1.8	-11.6	-18.4	-21.8	-22.4	-22.6	-25.8	-22.7	-15.1	-11.2	- 8.7	- 5.1	62.2	384.1

DIURNAL INEQUALITIES.



TABLE XVI.—Horizontal Force. Diurnal Inequality. (Unit 1γ.)

	Forenoon.												Afternoon.												Range.	Sum of 24 differences from the mean.
	1.	2.	3.	4.	5.	6.	7.	8.	9.	10.	11.	12.	1.	2.	3.	4.	5.	6.	7.	8.	9.	10.	11.	12.		
1902																										
April . . . .	- 8.2	-10.1	- 6.8	-10.3	- 9.3	- 8.9	- 8.5	- 4.9	- 0.7	+ 5.2	+ 9.2	+13.2	+19.1	+19.0	+15.3	+12.2	+12.5	+ 6.2	+ 1.0	- 2.4	- 6.4	-10.8	-14.7	-11.9	33.8	226.7
May . . . . .	- 9.6	-10.2	-10.4	-12.3	-14.9	-10.5	- 6.9	- 4.4	- 2.1	+ 1.6	+ 3.2	+ 6.9	+14.5	+18.1	+18.5	+17.3	+15.3	+11.3	+ 5.2	+ 0.2	- 4.4	- 6.2	-10.5	-10.0	33.4	224.5
June . . . . .	- 8.8	- 6.4	- 7.8	- 8.2	- 7.1	- 4.1	- 4.5	- 2.8	- 1.2	+ 1.4	+ 4.0	+ 8.8	+12.4	+13.4	+16.0	+11.6	+ 8.2	+ 5.9	+ 5.4	- 2.3	- 8.6	- 8.3	- 8.3	- 8.1	24.8	133.6
July . . . . .	- 6.7	- 8.0	- 4.3	- 3.7	- 4.9	- 6.8	- 3.8	- 2.8	- 0.9	+ 0.3	+ 3.0	+ 5.9	+10.2	+12.5	+12.0	+ 8.5	+ 7.8	+ 3.7	+ 1.6	- 1.0	- 5.4	- 6.4	- 6.0	- 5.8	20.5	132.0
August . . . .	- 8.1	- 8.4	- 9.9	- 8.0	- 6.8	- 5.9	- 5.6	- 3.3	+ 1.3	+ 5.0	+ 6.0	+ 9.6	+11.6	+12.2	+11.9	+11.7	+ 9.5	+ 5.9	+ 1.4	- 0.1	- 6.9	- 8.1	- 8.0	- 7.5	22.1	172.7
September . .	-11.7	- 8.4	-10.5	-11.9	-12.1	- 8.5	- 4.1	- 2.3	+ 1.9	+ 8.5	+12.1	+14.8	+16.6	+15.4	+14.8	+12.5	+ 8.2	+ 6.7	+ 1.1	- 4.7	- 7.1	- 8.8	-10.7	-12.9	29.5	226.3
October . . . .	-11.1	-11.2	-10.9	-10.3	- 9.2	- 7.2	- 7.5	- 4.3	+ 1.0	+ 5.0	+10.3	+13.4	+16.2	+16.9	+15.3	+15.8	+13.5	+ 8.2	+ 0.9	- 3.5	- 7.5	-10.7	-10.7	-11.7	28.6	232.3
November . . .	-17.7	-18.4	-19.0	-15.7	-14.5	- 9.0	-13.9	-18.3	- 4.4	+ 3.0	+ 9.3	+17.4	+24.6	+29.7	+31.8	+29.3	+18.6	+11.9	+ 3.5	- 2.7	- 6.7	-10.9	-12.0	-16.1	50.8	358.4
December . . .	-13.1	-17.4	-22.0	-31.0	-36.1	-31.1	-23.2	-14.8	- 8.0	+ 1.5	+12.5	+21.6	+30.8	+34.3	+29.4	+29.1	+25.2	+17.8	+12.9	+ 2.4	+ 2.7	- 0.8	-10.0	-12.1	70.4	439.8
1903																										
January . . . .	-14.8	-26.7	-28.1	-27.9	-30.8	-23.0	-14.7	-13.7	-20.8	-12.2	- 3.7	+11.7	+21.1	+26.5	+25.1	+31.4	+33.8	+30.9	+18.8	+16.2	+10.8	+ 2.2	- 0.6	-12.3	64.6	457.8
February . . .	-11.8	-13.9	-17.3	-18.4	-18.8	- 9.6	- 3.5	-10.6	- 3.3	+ 2.5	+ 7.6	+10.1	+21.1	+22.9	+20.4	+18.8	+18.3	+14.1	+ 5.1	- 0.9	- 0.9	- 6.7	-12.2	-12.0	41.7	280.8
March . . . . .	-12.0	-14.4	-12.5	-12.5	-13.6	-14.8	- 8.7	- 4.6	+ 1.1	+ 5.0	+11.8	+13.4	+17.1	+16.2	+15.9	+16.5	+14.6	+11.2	+ 4.8	+ 0.1	- 4.5	- 7.2	-10.1	-11.2	31.9	254.8
April . . . . .	-13.5	-16.3	-15.2	-16.7	-13.9	- 6.4	- 2.3	+ 4.0	+ 3.3	+ 7.7	+11.1	+13.9	+15.9	+16.9	+16.4	+13.3	+10.2	+ 9.5	+ 2.9	- 2.8	- 6.9	- 6.5	-17.0	- 8.3	33.9	250.9
May . . . . .	- 8.0	- 9.2	- 9.2	-10.4	- 8.6	- 6.1	- 5.3	- 0.8	+ 2.1	+ 5.7	+ 7.3	+10.2	+12.8	+12.0	+12.4	+12.4	+ 8.3	+ 6.7	+ 1.9	- 2.2	- 7.4	- 9.5	- 7.7	- 7.4	23.2	183.6
June . . . . .	-15.8	-10.6	-14.8	-13.3	-11.6	-10.7	- 9.1	- 4.5	+ 2.5	+ 7.7	+11.5	+15.2	+18.4	+16.3	+17.2	+13.6	+14.0	+ 9.8	+ 2.8	- 2.4	- 3.4	- 7.7	+ 9.3	-15.4	34.2	257.6
July . . . . .	- 4.7	- 7.9	-11.3	-11.7	-12.0	- 7.7	- 6.5	- 3.9	- 0.4	+ 1.8	+ 5.6	+ 9.5	+ 9.9	+13.1	+15.9	+17.7	+14.4	+ 7.9	+ 2.3	0.0	- 5.7	- 8.0	-10.2	- 8.5	29.7	196.6
August . . . .	-11.6	- 6.5	- 5.2	- 3.9	- 6.8	- 5.7	- 3.3	- 1.6	+ 0.4	+ 4.2	+ 4.1	+ 7.2	+10.2	+10.3	+12.6	+10.0	+ 7.3	+ 8.9	+ 2.9	- 0.6	- 4.3	- 5.3	- 9.6	-13.9	26.5	156.4
September . .	-12.4	- 6.2	- 9.3	- 8.4	- 4.1	- 5.9	- 7.0	- 3.1	+ 1.5	+ 4.7	+ 5.3	+ 7.8	+11.1	+18.6	+22.5	+17.1	+ 6.3	+ 4.9	- 0.5	- 4.0	-16.4	- 6.8	- 7.3	- 9.3	38.9	200.5

DIURNAL INEQUALITIES.

TABLE XVII.—Horizontal Force. Diurnal Inequality. (Unit 1γ.)

	Forenoon.												Afternoon.												Range.	Sum of 24 differences from the mean.
	1.	2.	3.	4.	5.	6.	7.	8.	9.	10.	11.	12.	1.	2.	3.	4.	5.	6.	7.	8.	9.	10.	11.	12.		
January . . .	-14.8	-26.7	-28.1	-27.9	-30.8	-23.0	-14.7	-13.7	-20.8	-12.2	-3.7	+11.7	+21.1	+26.5	+25.1	+31.4	+33.8	+30.9	+18.8	+16.2	+10.8	+2.2	-0.6	-12.3	64.6	457.8
February . . .	-11.8	-13.9	-17.3	-18.4	-18.8	-9.6	-3.5	-10.6	-3.3	+2.5	+7.6	+10.1	+21.1	+22.9	+20.4	+18.8	+18.3	+14.1	+5.1	-0.9	-0.9	-6.7	-12.2	-12.0	41.7	260.8
March . . .	-12.0	-14.4	-12.5	-12.5	-13.6	-14.8	-8.7	-4.6	+1.1	+5.0	+11.8	+13.4	+17.1	+16.2	+15.9	+16.5	+14.6	+11.2	+4.8	+0.1	-4.5	-7.2	-10.1	-11.2	31.9	254.8
April . . .	-10.8	-13.2	-11.0	-13.5	-11.6	-7.6	-5.4	-0.4	+1.3	+6.5	+10.2	+13.6	+17.5	+18.0	+15.9	+12.7	+11.3	+7.8	+1.9	-2.6	-6.7	-8.7	-15.9	-10.1	33.9	234.2
May . . .	-8.8	-9.7	-9.8	-11.4	-11.7	-8.3	-6.1	-2.6	0.0	+3.6	+5.3	+8.6	+13.6	+15.0	+15.5	+14.8	+11.8	+9.0	+3.6	-1.0	-5.9	-7.8	-9.1	-8.7	27.2	201.7
June . . .	-12.3	-8.5	-11.3	-10.7	-9.4	-7.4	-6.8	-3.6	+0.6	+4.5	+7.8	+12.0	+15.4	+14.9	+16.6	+12.6	+11.1	+7.8	+4.1	-2.3	-6.0	-8.0	-8.8	-11.7	27.9	214.2
July . . .	-5.7	-7.9	-7.8	-7.7	-8.4	-7.3	-5.1	-3.4	-0.6	+1.0	+4.3	+7.7	+10.0	+12.8	+13.9	+13.1	+11.1	+5.8	+2.0	-0.5	-5.5	-7.2	-8.1	-7.2	22.3	164.1
August . . .	-9.8	-7.5	-7.5	-6.0	-6.8	-5.8	-4.4	-2.5	+0.9	+4.6	+5.1	+8.4	+10.9	+11.3	+12.3	+10.9	+8.4	+7.4	+2.2	-0.3	-5.6	-6.7	-8.8	-10.7	23.0	164.8
September . .	-12.0	-7.3	-9.9	-10.1	-8.1	-7.2	-5.6	-2.7	+1.7	+6.6	+8.7	+11.3	+13.9	+17.0	+18.7	+14.8	+7.3	+5.8	+0.3	-4.4	-11.7	-7.8	-9.0	-11.1	30.7	213.0
October . . .	-11.1	-11.2	-10.9	-10.3	-9.2	-7.2	-7.5	-4.3	+1.0	+5.0	+10.3	+13.4	+16.2	+16.9	+15.3	+15.8	+13.5	+8.2	+0.9	-3.5	-7.5	-10.7	-10.7	-11.7	28.6	232.3
November . .	-17.7	-18.4	-19.0	-15.7	-14.5	-9.0	-13.9	-18.3	-4.4	+3.0	+9.3	+17.4	+24.6	+29.7	+31.8	+29.3	+18.6	+11.9	+3.5	-2.7	-6.7	-10.9	-12.0	-16.1	50.8	358.4
December . .	-13.1	-17.4	-22.0	-31.0	-36.1	-31.1	-23.2	-14.8	-8.0	+1.5	+12.5	+21.6	+30.8	+34.3	+29.4	+29.1	+25.2	+17.8	+12.9	+2.4	+2.7	-0.8	-10.0	-12.1	70.4	439.8
Year . . .	-11.7	-13.0	-13.9	-14.6	-14.9	-11.5	-8.7	-6.8	-2.5	+2.6	+7.4	+12.4	+17.7	+19.6	+19.2	+18.3	+15.4	+11.5	+5.0	0.0	-4.0	-6.7	-9.6	-11.2	34.5	258.2
Midwinter . .	-8.9	-8.7	-9.6	-9.9	-9.8	-7.7	-6.0	-3.2	0.0	+3.0	+5.8	+9.4	+13.0	+14.2	+15.3	+13.5	+11.3	+7.5	+3.2	-1.3	-5.8	-7.7	-8.7	-9.2	25.2	192.7
Equinox . . .	-11.5	-11.5	-11.1	-11.6	-10.6	-9.2	-6.8	-3.0	+1.3	+5.8	+10.2	+12.9	+16.2	+17.0	+16.5	+15.0	+11.6	+8.2	+2.0	-2.6	-7.6	-8.6	-11.4	-11.0	28.6	233.2
Midsummer	-15.2	-20.8	-23.0	-24.9	-27.1	-21.0	-17.3	-15.6	-11.1	-2.6	+6.0	+16.9	+25.5	+30.2	+28.8	+29.9	+25.9	+20.2	+11.7	+5.3	+2.3	-3.2	-7.5	-13.5	57.3	405.5

DIURNAL INEQUALITIES.

TABLE XVIII.—Vertical Force. Diurnal Inequality. (Unit 1γ.)

	Forenoon.												Afternoon.												Range.	Sum of 24 differences from the mean.
	1.	2.	3.	4.	5.	6.	7.	8.	9.	10.	11.	12.	1.	2.	3.	4.	5.	6.	7.	8.	9.	10.	11.	12.		
1902																										
March . . .	+10	0	+6	+6	+4	+2	+4	+6	-2	-6	-19	-19	-21	-19	-13	-6	-2	+4	+6	+8	+14	+16	+12	+10	37	215
April . . .	+16	+7	+2	+2	-6	-9	-9	-14	-13	-21	-17	-24	-24	-7	0	+2	+5	+12	+12	+12	+15	+18	+22	+19	46	288
May . . .	+4	+6	+5	+1	-2	-5	-4	-7	-9	-12	-8	-6	-6	+4	+4	-2	+5	+6	+3	+3	+4	+7	+4	+6	19	123
June . . .	+7	+7	+3	+1	-1	-3	-4	-6	-6	-4	-9	-11	-9	-4	-3	-2	-3	+1	+5	+6	+10	+9	+11	+4	22	129
July . . .	+6	+1	+4	-2	-3	-3	-4	-4	-7	-7	-8	-7	-7	-1	-2	-1	+4	+6	+5	+7	+6	+7	+6	+6	15	114
August . . .	+4	+2	+1	-2	-4	-9	-11	-12	-11	-12	-11	-10	-4	0	+5	+7	+7	+8	+10	+9	+10	+10	+8	+5	22	172
September . .	+11	+11	+5	+8	+5	-2	-3	-7	-11	-14	-15	-15	-11	-8	-5	-3	-2	+5	+7	+11	+10	+7	+7	+9	26	192
October . . .	+9	+9	+7	+5	+4	+3	+3	0	-5	-13	-13	-16	-16	-16	-12	-6	-2	+3	+6	+7	+9	+10	+11	+10	27	195
November . .	+21	+19	+17	+13	-1	-6	-8	-18	-25	-23	-22	-24	-23	-18	-10	-1	+5	+8	+11	+15	+17	+18	+17	+19	46	359
December . .	+15	+16	+15	+6	+2	-3	+2	-5	-12	-17	-31	-32	-21	-14	-10	-3	+3	+4	+7	+10	+14	+18	+17	+19	51	296
1903																										
January . . .	+14	+23	+24	+27	+22	+19	+23	+38	+16	-22	-31	-42	-39	-32	-24	-22	-13	-3	-3	-5	-2	+3	+9	+13	80	469
February . . .	+15	+18	+19	+14	+5	+3	+7	+5	+7	-4	-13	-18	-30	-33	-28	-17	-9	0	+5	+10	+9	+11	+10	+13	52	303
March . . .	+22	+18	+17	+13	+11	+12	+9	+6	-3	-13	-29	-30	-29	-30	-25	-17	-13	-4	+5	+9	+16	+16	+17	+21	52	385
April . . .	+9	+12	+11	+4	+1	-7	-7	-11	-13	-12	-16	-19	-17	-11	-8	-3	+2	+4	+13	+13	+16	+14	+13	+11	35	247
May . . .	+8	+5	+3	0	-1	+2	+3	+2	-1	-2	-5	-10	-12	-15	-12	-6	-5	+2	+5	+5	+7	+8	+10	+8	25	137
June . . .	+8	+10	+4	+4	+3	0	-5	-5	-9	-9	-9	-8	-8	-9	-7	-4	+3	+8	+6	+8	+7	+4	+5	+6	19	149
July . . .	+7	+3	-1	+4	0	-5	-10	-13	-14	-14	-13	-13	-11	-12	-9	+1	+7	+6	+12	+18	+19	+15	+12	+10	33	229
August . . .	+15	+16	+9	+3	-4	-4	-6	-10	-10	-12	-15	-20	-18	-16	-13	-3	+4	+4	+5	+16	+19	+14	+13	+12	39	261
September . .	+16	+10	+7	+6	+5	0	-4	-3	-1	-12	-15	-16	-24	-22	-15	-8	-6	+3	+10	+10	+12	+15	+16	+16	40	252
October . . .	+15	+15	+10	-3	-1	-3	+1	-6	+4	-3	-12	-19	-23	-16	-19	-8	-3	-10	+3	+17	+10	+17	+21	+13	44	252
November . .	+14	+23	+4	+13	-6	+5	+22	+13	-18	-5	-23	-39	-25	-32	-29	-14	+3	+10	+13	+12	+18	+27	+11	+12	66	401
December . .	+59	+48	+47	+43	+41	+11	0	-11	-24	-60	-71	-63	-60	-30	-39	-24	-10	+2	+10	+13	+24	+28	+28	+33	130	784

DIURNAL INEQUALITIES.

TABLE XIX.—Vertical Force. Diurnal Inequality. (Unit 1γ.)

	Forenoon.												Afternoon.												Range.	Sum of 24 differences from the mean.
	1.	2.	3.	4.	5.	6.	7.	8.	9.	10.	11.	12.	1.	2.	3.	4.	5.	6.	7.	8.	9.	10.	11.	12.		
January . . .	+14	+23	+24	+27	+22	+19	+23	+38	+16	-22	-31	-42	-39	-32	-24	-22	-13	-3	-3	-5	-2	+3	+9	+13	80	469
February . . .	+15	+18	+19	+14	+5	+3	+7	+5	+7	-4	-13	-18	-30	-33	-28	-17	-9	0	+5	+10	+9	+10	+10	+13	52	303
March . . .	+16	+9	+12	+10	+7	+7	+6	+6	-3	-10	-24	-24	-25	-24	-19	-12	-8	0	+5	+9	+15	+16	+15	+15	41	297
April . . .	+13	+9	+6	+3	-3	-8	-8	-12	-13	-16	-16	-22	-20	-9	-4	0	+3	+8	+13	+13	+15	+16	+17	+15	39	262
May . . .	+6	+6	+4	0	-1	-2	-1	-3	-5	-7	-7	-8	-9	-5	-4	-4	0	+4	+4	+4	+6	+8	+7	+7	17	112
June . . .	+7	+9	+3	+2	+1	-1	-5	-5	-8	-7	-9	-10	-9	-6	-5	-3	0	+5	+6	+7	+8	+7	+8	+5	19	136
July . . .	+6	+2	+1	+1	-1	-4	-7	-9	-11	-11	-11	-10	-9	-6	-6	0	+6	+6	+9	+13	+12	+11	+9	+8	24	169
August . . .	+9	+9	+5	0	-4	-7	-9	-11	-10	-12	-13	-15	-11	-8	-4	+2	+6	+6	+8	+13	+14	+12	+11	+9	29	208
September . . .	+14	+10	+6	+7	+5	-1	-4	-5	-6	-13	-15	-15	-18	-15	-10	-5	-4	+4	+8	+10	+11	+11	+11	+13	32	221
October . . .	+12	+12	+9	+1	+2	0	+2	-3	0	-8	-12	-17	-19	-16	-15	-7	-3	-3	+4	+12	+9	+13	+16	+12	35	207
November . . .	+19	+20	+14	+13	-2	-4	-2	-12	-24	-19	-22	-27	-25	-21	-14	-4	+4	+9	+12	+14	+17	+20	+16	+18	47	352
December . . .	+24	+22	+22	+14	+10	0	+1	-7	-14	-25	-39	-38	-29	-17	-16	-7	0	+4	+8	+10	+16	+20	+19	+22	63	384
Year . . .	+13	+12	+10	+8	+3	0	0	-2	-6	-13	-17	-20	-20	-16	-12	-6	-1	+3	+6	+9	+11	+12	+12	+13	33	225
Midwinter . . .	+7	+5	+3	+1	-1	-3	-4	-6	-8	-8	-9	-9	-9	-6	-5	-2	+2	+5	+6	+8	+9	+9	+8	+7	18	140
Equinox . . .	+14	+10	+8	+5	+3	0	-1	-4	-5	-12	-17	-20	-21	-16	-12	-6	-3	+2	+8	+11	+13	+14	+15	+14	36	234
Midsummer . . .	+19	+22	+20	+18	+10	+5	+8	+7	-7	-22	-31	-36	-31	-23	-18	-11	-3	+3	+6	+7	+10	+14	+15	+18	58	364

DIURNAL INEQUALITIES.

TABLE XX.—Inclination. Diurnal Inequality.

	Forenoon.												Afternoon.												Range.	Sum of 24 differences from the mean.
	1.	2.	3.	4.	5.	6.	7.	8.	9.	10.	11.	12.	1.	2.	3.	4.	5.	6.	7.	8.	9.	10.	11.	12.		
January . . .	+0.77	+1.37	+1.45	+1.45	+1.57	+1.18	+0.80	+0.82	+1.06	+0.49	+0.04	-0.74	-1.18	-1.41	-1.30	-1.60	-1.67	-1.49	-0.91	-0.80	-0.52	-0.09	+0.07	+0.64	3.24	23.42
February . . .	+0.63	+0.74	+0.91	+0.94	+0.92	+0.47	+0.20	+0.53	+0.19	-0.14	-0.42	-0.56	-1.14	-1.24	-1.10	-0.97	-0.91	-0.67	-0.22	+0.09	+0.08	+0.37	+0.63	+0.63	2.18	14.70
March . . .	+0.64	+0.73	+0.85	+0.64	+0.68	+0.74	+0.44	+0.25	-0.06	-0.28	-0.67	-0.74	-0.93	-0.88	-0.84	-0.84	-0.73	-0.53	-0.21	+0.04	+0.28	+0.41	+0.55	+0.60	1.67	13.36
April . . .	+0.57	+0.66	+0.55	+0.66	+0.54	+0.33	+0.22	-0.03	-0.12	-0.38	-0.56	-0.75	-0.92	-0.90	-0.78	-0.61	-0.52	-0.34	-0.03	+0.18	+0.39	+0.49	+0.84	+0.56	1.76	11.93
May . . .	+0.45	+0.49	+0.48	+0.54	+0.55	+0.39	+0.29	+0.11	-0.02	-0.20	-0.28	-0.45	-0.69	-0.74	-0.76	-0.72	-0.56	-0.41	-0.15	+0.07	+0.31	+0.41	+0.46	+0.45	1.31	9.98
June . . .	+0.62	+0.45	+0.55	+0.52	+0.45	+0.35	+0.30	+0.15	-0.06	-0.25	-0.41	-0.62	-0.77	-0.74	-0.81	-0.61	-0.53	-0.35	-0.17	+0.14	+0.32	+0.41	+0.46	+0.58	1.43	10.62
July . . .	+0.30	+0.39	+0.38	+0.37	+0.40	+0.33	+0.21	+0.12	-0.02	-0.10	-0.25	-0.41	-0.52	-0.64	-0.69	-0.63	-0.50	-0.25	-0.06	+0.08	+0.31	+0.39	+0.43	+0.38	1.12	8.16
August . . .	+0.51	+0.40	+0.38	+0.29	+0.31	+0.25	+0.17	+0.07	-0.09	-0.27	-0.30	-0.47	-0.57	-0.57	-0.61	-0.51	-0.38	-0.33	-0.07	+0.07	+0.33	+0.37	+0.47	+0.55	1.16	8.34
September . . .	+0.63	+0.39	+0.50	+0.51	+0.41	+0.34	+0.25	+0.11	-0.11	-0.37	-0.48	-0.61	-0.74	-0.88	-0.94	-0.73	-0.37	-0.26	+0.02	+0.25	+0.61	+0.42	+0.48	+0.59	1.57	11.00
October . . .	+0.58	+0.59	+0.56	+0.50	+0.45	+0.34	+0.37	+0.19	-0.05	-0.27	-0.54	-0.71	-0.86	-0.88	-0.80	-0.78	-0.66	-0.40	-0.02	+0.22	+0.40	+0.57	+0.58	+0.61	1.49	11.93
November . . .	+0.94	+0.96	+0.98	+0.81	+0.69	+0.40	+0.63	+0.79	+0.10	-0.24	-0.54	-0.94	-1.27	-1.50	-1.56	-1.40	-0.87	-0.53	-0.12	+0.19	+0.39	+0.60	+0.65	+0.85	2.54	17.95
December . . .	+0.69	+0.90	+1.12	+1.51	+1.73	+1.47	+1.12	+0.68	+0.33	-0.15	-0.73	-1.17	-1.56	-1.70	-1.45	-1.40	-1.19	-0.83	-0.58	-0.07	-0.07	+0.12	+0.55	+0.66	3.43	21.78
Year . . .	+0.61	+0.68	+0.71	+0.73	+0.73	+0.55	+0.42	+0.32	+0.10	-0.18	-0.43	-0.68	-0.93	-1.01	-0.97	-0.90	-0.74	-0.53	-0.21	+0.04	+0.24	+0.37	+0.51	+0.60	1.74	13.19
Midwinter . . .	+0.46	+0.44	+0.47	+0.48	+0.47	+0.36	+0.27	+0.13	-0.03	-0.18	-0.31	-0.49	-0.66	-0.71	-0.75	-0.65	-0.53	-0.34	-0.13	+0.10	+0.31	+0.40	+0.45	+0.47	1.23	9.59
Equinox . . .	+0.60	+0.59	+0.57	+0.58	+0.52	+0.44	+0.32	+0.13	-0.09	-0.32	-0.56	-0.70	-0.86	-0.89	-0.84	-0.74	-0.57	-0.38	-0.06	+0.17	+0.42	+0.47	+0.61	+0.59	1.50	12.02
Midsummer . . .	+0.80	+1.08	+1.18	+1.26	+1.33	+1.02	+0.85	+0.76	+0.50	+0.03	-0.41	-0.95	-1.34	-1.54	-1.44	-1.47	-1.24	-0.95	-0.54	-0.23	-0.07	+0.21	+0.42	+0.72	2.87	20.34

DIURNAL INEQUALITIES.

TABLE XXI.—Southern Component. Diurnal Inequality. (Unit 1γ.)

	Forenoon.												Afternoon.												Range.	Sum of 24 differences from the mean.
	1.	2.	3.	4.	5.	6.	7.	8.	9.	10.	11.	12.	1.	2.	3.	4.	5.	6.	7.	8.	9.	10.	11.	12.		
Midwinter . .	- 7.9	- 6.5	- 5.5	- 2.9	- 1.4	+ 1.3	+ 3.7	+ 6.7	+10.1	+13.0	+14.3	+15.3	+15.0	+13.4	+10.2	+ 3.9	- 0.4	- 6.8	-10.7	-14.1	-15.0	-14.5	-11.4	- 9.7	30.3	213.7
Equinox . .	-10.6	- 7.8	- 3.8	- 1.7	+ 2.5	+ 7.1	+ 9.7	+14.8	+20.6	+22.3	+22.6	+19.2	+15.0	+ 9.1	+ 2.1	- 2.6	- 7.9	-12.5	-16.9	-18.4	-19.2	-16.3	-14.7	-12.4	41.8	289.8
Midsummer .	-17.6	-16.1	-16.0	-10.4	-11.3	- 0.9	+ 4.1	+14.6	+20.5	+23.8	+20.3	+23.6	+25.4	+22.7	+12.0	+ 7.5	+ 0.8	- 5.8	-14.4	-16.8	-16.6	-16.1	-18.1	-15.6	43.5	351.0
Year . . . .	-12.2	- 9.9	- 7.9	- 4.7	- 2.6	+ 3.2	+ 7.3	+12.8	+18.3	+21.0	+20.1	+19.6	+18.6	+14.1	+ 7.3	+ 1.8	- 3.8	- 9.2	-14.9	-17.3	-17.6	-16.1	-15.2	-13.0	38.6	288.5

02

TABLE XXII.—Western Component. Diurnal Inequality. (Unit 1γ.)

	Forenoon.												Afternoon.												Range.	Sum of 24 differences from the mean.
	1.	2.	3.	4.	5.	6.	7.	8.	9.	10.	11.	12.	1.	2.	3.	4.	5.	6.	7.	8.	9.	10.	11.	12.		
Midwinter . .	+ 4.1	+ 6.4	+10.2	+15.9	+18.5	+19.2	+20.2	+19.8	+19.3	+18.4	+14.9	+ 9.0	+ 0.5	- 5.0	-13.5	-21.8	-25.4	-29.2	-27.5	-24.2	-16.3	-11.2	- 3.0	+ 1.3	49.4	354.8
Equinox . .	+ 4.6	+ 9.9	+16.9	+22.1	+28.0	+34.0	+33.9	+35.4	+37.2	+30.5	+21.5	+ 9.0	- 6.3	-19.4	-32.1	-37.9	-40.7	-42.8	-37.2	-30.1	-20.6	-12.8	- 3.4	+ 0.3	79.5	566.1
Midsummer .	- 1.0	+14.3	+19.3	+34.2	+37.3	+44.2	+45.8	+62.5	+63.9	+51.9	+26.4	+ 8.9	- 6.5	-22.1	-39.6	-50.7	-54.9	-56.1	-53.4	-44.1	-37.1	-24.3	-18.7	- 0.8	120.0	818.0
Year . . . .	+ 2.0	+ 9.6	+15.2	+22.7	+27.6	+31.3	+33.2	+39.6	+41.2	+34.8	+22.6	+11.0	- 2.7	-15.5	-27.7	-36.7	-40.9	-42.7	-39.7	-33.8	-25.4	-16.7	- 8.5	- 0.4	83.9	581.5

DIURNAL INEQUALITIES.

§25. In forming the diurnal inequalities, use was made of the readings for the first and last midnights of the local day. The non-cyclic increment  $N$ —*i.e.* the algebraic excess of the mean value for the second over that for the first midnight—was eliminated by applying to the mean value for hour,  $n$ , the correction  $+ N(12 - n)/24$ , where  $n$  is counted from 0 to 24. Particulars of the mean diurnal non-cyclic change for the days actually employed in calculating the diurnal inequalities are given in Table XXIII.

TABLE XXIII.—Non-cyclic Changes.

	Declination.				Horizontal Force.		Vertical Force.	
	All days.		Quieter days.		1902.	1903.	1902.	1903.
	1902.	1903.	1902.	1903.				
January . . . . .	—	-1.5	—	-5.5	$\gamma$	-14.5	$\gamma$	-24.1
February . . . . .	—	-0.3	—	+1.7	—	+3.6	—	—
March . . . . .	-2.8	0.0	—	-2.7	—	-1.8	—	+1.7
April . . . . .	-1.8	+2.7	-2.7	+0.1	-5.3	-0.4	-11.0	-11.2
May . . . . .	+0.8	+0.1	-0.3	-0.7	-3.8	+0.5	+2.2	-16.2
June . . . . .	+0.7	+1.2	+0.1	+0.2	+0.6	-2.8	-6.3	+1.6
July . . . . .	+0.7	+1.2	+0.1	+1.3	-1.0	+2.6	-3.1	-10.4
August . . . . .	-0.6	+1.3	-0.6	+0.6	-0.6	-0.1	-4.3	-5.7
September . . . . .	+1.3	+0.9	+0.7	-3.5	+0.7	+2.3	-6.0	-20.8
October . . . . .	+1.4	—	+2.8	—	+1.6	—	-3.4	+7.2
November . . . . .	-0.5	—	-4.1	—	+2.7	—	+7.7	—
December . . . . .	-1.0	—	+2.5	—	+6.2	—	+5.8	—

In the case of the Declination, results are given both for all days and for quieter days, *i.e.* for the days on which depend the inequalities in Tables XII and XIV respectively. Omitting March, 1902, for which no quieter-days' results existed, we find that the mean daily non-cyclic change of Declination from the 18 months April, 1902, to September, 1903, was  $+0.37$  for all days, as against  $-0.56$  for quieter days. So substantial a difference suggests that the difference between the quieter days and the others is not wholly accidental. The great preponderance of individual months in which the all-days' non-cyclic change is algebraically larger than the quieter-days' change points to the same conclusion. Accepting the difference as real, we should infer that on the representative quieter day the progressive increment of the easterly Declination is algebraically less than on the representative all-day by the amount  $0.56 + 0.37$ , or  $0.93$ . We have already seen in Table IV that the mean value of the easterly Declination for the representative quieter day was less than that for the representative all-day to the extent  $1.46$ . An analogous phenomenon has been observed elsewhere in the case of the Horizontal Force. Thus according to ELLIS the average non-cyclic increment of Horizontal Force at Greenwich on quiet days from 1890 to 1895 was  $+4.3\gamma$ , while the absolute value of the force on the representative quiet day of the epoch 1889 to 1896 exceeded that from the average day by  $3.3\gamma$ . The apparent parallelism may be pure accident, but it merits recognition as a possibly important key to the study of the relationship between non-cyclic changes and disturbances.

Taking the all-days' Declination results, the mean non-cyclic change from the 18 months April, 1902, to September, 1903, as already stated, is  $+0.37$ . If we include March, 1902, the mean falls to  $+0.20$ ; while if we take a mean from a year, combining common months in 1902 and 1903, it falls to  $+0.083$ . Even at the last figure we should deduce an annual change of  $+30.0$ , which is much in excess of the secular change obtained in Table VII. Both the non-cyclic and the Table VII secular-change data can claim to be regarded as natural magnetic changes only if the base-line value of the Declination curves was invariable. But if this be granted, it would appear at first sight that they ought to give identical values for the secular change. It should, however, be remembered that the non-cyclic data in Table XXIII are based only on days on which the record was complete, so that all highly disturbed days are excluded, whereas all days, however disturbed, contribute to the secular change. There is thus no necessary inconsistency between the results of Tables XXIII and VII. If, however, we are to avoid an inconsistency, we must suppose that on the average day for which no complete Declination record existed—or we may say for the

average highly disturbed day—the non-cyclic change was opposite in sign to that on the average all-day of Table XXIII, and so the same in sign as that in the average quieter day. Also the non-cyclic change on the highly disturbed days must have been numerically large, at least  $-0\cdot2$ . It must be allowed that this result looks at first sight exceedingly improbable, as one would expect *a priori* that the non-cyclic phenomena on quiet days and on highly disturbed days would be the opposite of one another. However, probable or improbable, the fact remains that exactly the same phenomenon has been recently discovered at Kew, where instrumental uncertainties are too small to be of importance. At Kew the non-cyclic change was found on the average highly disturbed day of the 11 years 1890 to 1900 to agree in sign with that on the average quiet day, while differing in sign from that on the average day of the year (and so from the secular change). The direction of the secular change of Declination has altered at most places within historical times, and presumably will alter from time to time in the future. Thus here again we appear on the threshold of a most suggestive line of inquiry.

The mean non-cyclic change given by Table XXIII for the Horizontal Force,  $-0\cdot53\gamma$ , would give in a year of average days an apparent decrease of  $194\gamma$ , whereas Table VI gives a secular increase of  $150\gamma$ . No necessary inconsistency, however, exists between these figures, because the difference between them *may* mean nothing beyond a diminution in the magnetic moment of the Horizontal-Force magnet, which would have exactly the same effect, so far as the non-cyclic change is concerned, as a real decrease of Horizontal Force. A fall of 4·3 per cent. per annum in the moment of the Horizontal-Force magnet would suffice to wholly account for the non-cyclic change observed.

In February, 1903, the diurnal inequality of Vertical Force was based on only eight "days" or periods of 24 successive hours, and only three of these commenced at local midnight. Thus no value is assigned in that month to the non-cyclic change of Vertical Force. It was, as a matter of fact, large and negative on each of the three actual days, the average amount being  $-38\gamma$ . Excluding February, 1903, there were 18 months possessing a sufficient number of complete days to be worth taking into account. The results for individual months vary much, but have a decidedly negative tendency, the mean from the 18 months being  $-5\cdot35\gamma$ . A real change of  $5\cdot35\gamma$  per diem in V would mean a change of  $\cdot01954$  per annum. An apparent decrease of  $5\cdot35\gamma$  per diem would, however, be equally well accounted for by a fall of about 2·7 per cent. per annum in the moment of the Vertical-Force magnet. This is really a smaller change than that required to account for the non-cyclic change observed in the case of the Horizontal Force, and it seems of by no means an improbable magnitude.

§26. The inequalities for the 12 months, the year, and the three seasons are also shown graphically in figs. 1 to 13, pp. 104 to 116.

In the case of individual months, especially in Summer, the irregularities in the hourly values arising from disturbances catch the eye whether one looks at the diagrams or the tables. They are, however, much less prominent than one would have anticipated from a survey of the magnetic curves or of the hourly tabulations, and, when one comes to the mean seasonal results, the smoothness is not a little remarkable.

Considering the Declination inequalities in Tables XII to XV more closely, it will be seen that, so far as the general type is concerned, the differences between all and quiet days, or between the different seasons of the year, are comparatively small. There is a single daily oscillation, the extreme positions being reached about 9 a.m. and 6.30 p.m., the whole year round.

If in the figure NS represent the geographical Meridian, N being to the north, and EW the east-west line, then if *ns* represent the direction of the Declination needle, the angle *Non* was about  $152^{\circ} 40'$  on the average. It was largest about 9 a.m., and least about 6.30 p.m.

Though the type of the diurnal inequality did not vary much with the season, the amplitude varied largely, being greatest in Midsummer (about December), and least in Midwinter (about June). Considering, however, that the sun was continually below the horizon in Midwinter, the wonder is not so much that the range at that season was markedly less than at Midsummer as that it attained the size it actually did.

Comparing Tables XII and XIV, it will be seen that with the exception of January, 1903, all months

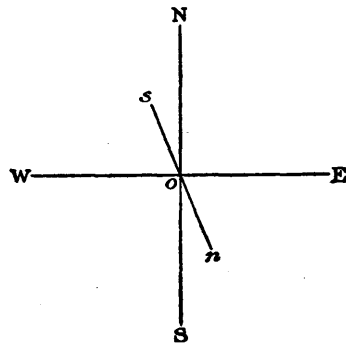



gave a smaller range for the quieter days than for all days, the difference being usually conspicuous, especially at Midwinter. It should also be remembered that the days of the largest disturbances did not contribute to Table XII, as the traces did not remain on the sheet, while the quieter days included about half those that were tabulated, and so cannot be regarded as representing any very high standard of Antarctic quietness. Thus the differences between the amplitudes of the *regular* diurnal inequalities on the very quietest and the most disturbed days must presumably be considerably larger even than those presented by Tables XII and XIV.

§27. In the case of the Horizontal Force prior to April, 1902, and subsequent to September, 1903, there were practically no days during which the registration was complete, so that diurnal inequalities are limited to the 18 months April, 1902, to September, 1903. Even between these dates there were various months, especially January and February, 1903, when only about one day in three gave a complete record. Considering this fact, the inequality curves, especially the seasonal ones, are much smoother than might have been expected. As with the Declination, the type of the diurnal inequality seems to vary but little throughout the year; the tendency is towards a single maximum about 2 or 3 p.m., and a single minimum in the early morning. The annual variation in the amplitude of the diurnal inequality is well marked. But even in June, 1902—which was not far from sunspot minimum—*i.e.* in the depth of the Antarctic Winter, the amplitude exceeded  $20\gamma$ .

As to the relative sizes of the diurnal changes in Declination and Horizontal Force, a change of 1' in D answered roughly to a force of  $1.91\gamma$ , so that taking the mean results for the year we have for the amplitudes  $45.5$  or  $87\gamma$  in D as against  $35\gamma$  in H. It must be remembered, however, that a good many days contributed to the D inequalities which were too disturbed to contribute to the H, and if these days had been excluded from the D inequalities the amplitudes of these would probably have been reduced. Still, even if we confined ourselves to the quieter days of Table XV, we should obtain for D, from the year as a whole, an average daily range of  $34'$  or  $65\gamma$ . This is nearly double the corresponding value for H. It is thus certain that the forces to which the diurnal inequality is due are less potent in the plane of the magnetic Meridian than in the perpendicular plane.

§28. The Vertical-Force trace itself seldom went off the sheet, but loss of temperature trace was less uncommon. Also in some months a good many days' traces which were complete were omitted because there was reason to doubt whether the instrument was working. In some cases the magnet was evidently stuck. The space in which it moved gave very little clearance, and presumably the magnet—whose azimuth was approximately east and west magnetic—tended to shift in azimuth, and so came in contact with the adjacent metal. In other cases it was impossible to feel certain from mere inspection of the trace that the magnet was stuck, while the extreme quietness of the trace suggested that it was. In such cases one was generally able to settle the question by reference to the temperature trace. If temperature changed sensibly—and it usually did—and the Vertical-Force trace showed no sympathetic movement, then one inferred that the magnet was stuck, and rejected the day's record.

Table XVIII gives inequalities for all the individual months from March, 1902, to December, 1903. The inequalities, however, for November and December, 1903, are each based on only 4 days' records, and the temperature-correction data for these were more than usually uncertain. Thus little weight has been allowed these as compared to the corresponding months in 1902 when forming the inequalities in Table XIX.

There is an apparent difference, clearly visible in fig. 11, between the types of the diurnal inequality of Vertical Force at different seasons. At Midsummer the force, instead of falling continuously from a maximum near midnight to a minimum near noon, shows a tendency to a slight increase about 6 to 8 a.m., and there is at least a suspicion of the same phenomenon in the equinoctial months. The phenomenon may be a real one, but it ought to be mentioned that disturbances in V were more prevalent from 4 to 9 a.m. than at other hours, and their satisfactory elimination might require several years' data.

§29. The diurnal inequalities of Inclination in Table XX were calculated from the corresponding V and H inequalities by means of the formula

$$\delta I = \delta V \times .00441 - \delta H \times .0477.$$

Here  $\delta I$ ,  $\delta V$ ,  $\delta H$  denote the departures at any, the same, hour from the mean values of I, V and H for the day. The numerical multipliers .00441 and .0477 answer to the mean values of V and H during the stay

at Winter Quarters. The contribution from  $H$  to  $\delta I$  is usually much the larger. Thus the curves in fig. 12 have a considerable resemblance to those in fig. 10, with the sign of the ordinates reversed. The Midsummer curve, however, in fig. 12 shows a slackening in the rate of fall of  $I$  about 7 or 8 a.m., which is due to the influence of the  $V$  contribution.

Winter Quarters was only about 400 miles from the position which Commander CHETWYND has deduced for the south magnetic Pole. Thus, if the diurnal inequality is due to electrical currents in the upper atmosphere, we should on the whole expect no great difference to exist between the amplitudes of the diurnal inequality of  $I$  at Winter Quarters and in the immediate neighbourhood of the Pole itself. This would imply, of course, a considerable diurnal variation in the actual position of the Pole. The probable nature of this movement may be derived from the consideration that an increased Inclination at Winter Quarters is presumably equivalent to a diminution in its distance from the magnetic Pole. Inclination was largest at Winter Quarters about 4 or 5 a.m. in the morning, so that the magnetic Pole was presumably at that hour displaced towards Winter Quarters, *i.e.* was to the SE of its mean position for the day. Inclination at Winter Quarters was lowest from 2 to 3 p.m., so that the magnetic Pole at that hour is probably to the NW of its mean position for the day.

§30. From a mathematical standpoint much is to be said for treating the diurnal variation of the components of force in and perpendicular to the geographical Meridian as fundamental rather than those of the Declination and Horizontal Force. The arguments in favour of this course are in some respects stronger for Winter Quarters than for an ordinary station, because the magnetic Meridian there was so highly variable. Again, if the causes to which the diurnal inequality is due are related to the Earth's axis of rotation rather than to the position of the magnetic Pole, the diurnal inequalities of the components  $S$  and  $W$ , directed to geographical south and west, are likely to be much less variable round a parallel of latitude than those of  $D$  and  $H$ . If the orientation of the spot relative to an adjacent magnetic Pole is of none, or of but secondary importance, the diurnal inequalities of  $D$  and  $H$  at Winter Quarters probably differ largely from those at other stations only 50 or 60 miles to the west, whereas the diurnal inequalities in  $S$  and  $W$  are unlikely to differ much. On the other hand, any element of uncertainty that may attach to the absolute value of the Declination enters into the diurnal inequalities of  $S$  and  $W$ , whereas it hardly enters into the diurnal inequality of  $D$  itself. Another drawback is that the  $S$  and  $W$  inequalities each depend on both  $D$  and  $H$ , whereas the days contributing to the  $D$  and  $H$  inequalities differ to some extent. If the  $D$  and  $H$  contributions to  $S$  and  $W$  had been derived strictly from the same days, the results would probably have been slightly different from those actually obtained. This last source of uncertainty might of course have been avoided, but, considering all the circumstances, it seemed hardly worth while to recalculate  $D$  and  $H$  inequalities from a common series of days.

The methods of calculating the inequalities in Tables XXI and XXII have been already explained in §23. Both  $S$  and  $W$  show only a single daily period. The extreme values of  $W$  occur distinctly earlier in the day than those of  $S$ . As appears either from the ranges or the sum of the hourly differences from the mean, the amplitude of the daily changes of  $W$  is more variable throughout the year than is that of  $S$ .

The inequalities of  $S$  and  $W$  are combined and shown graphically in the vector diagrams of figs. 13. In these  $NS$  and  $EW$  are drawn respectively in and perpendicular to the geographical Meridian, and the ends of the lines denoted by the letters  $N$ ,  $S$ , &c., are each at a distance from the point of intersection which represents  $10\gamma$  on the scale to which all the diagrams are drawn. The crosses and the numbers attached answer to the hours of the day counted from 0, local midnight. The line drawn from the intersection of  $NS$  and  $EW$  to a particular cross represents in direction and magnitude the horizontal component of the force—acting on the *north* pole of the magnet—to which may be ascribed the departure of the magnetic elements at the hour indicated from their mean value for the whole 24 hours. The diagrams are all described anti-clockwise, and so in the opposite direction to corresponding diagrams for English stations.

Being based on less than 2 years' data, the diagrams are naturally not very smooth, but their general form is remarkably symmetrical. The difference of type between the diagrams for the different seasons is unusually small. Another exceptional feature is the comparative smallness of the difference between day and night, the angular velocity of the vector being only very slightly less during the 12 hours centring at midnight than during the corresponding "day" hours.

DIURNAL INEQUALITIES.

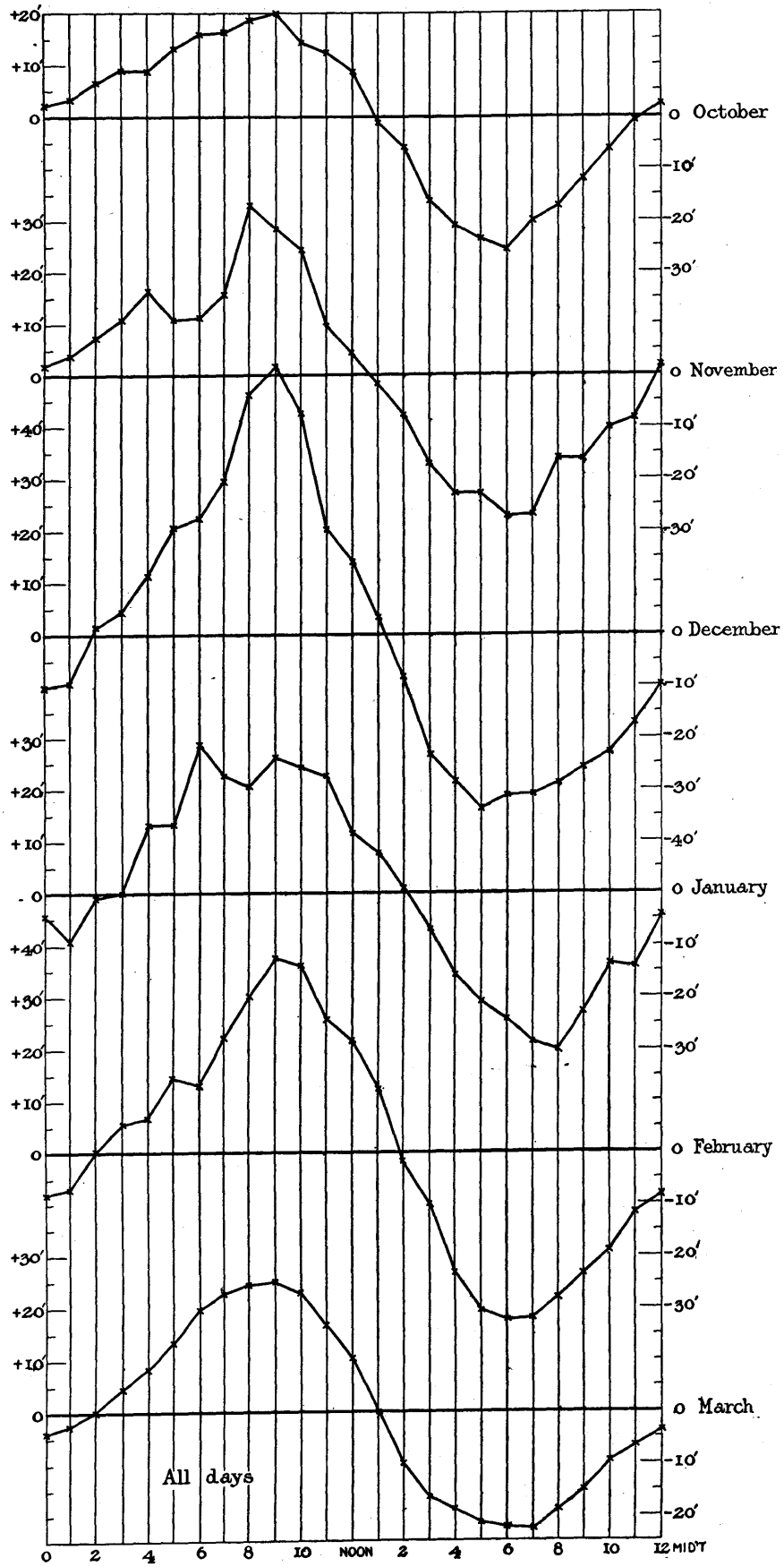

Fig. 1. Declination.

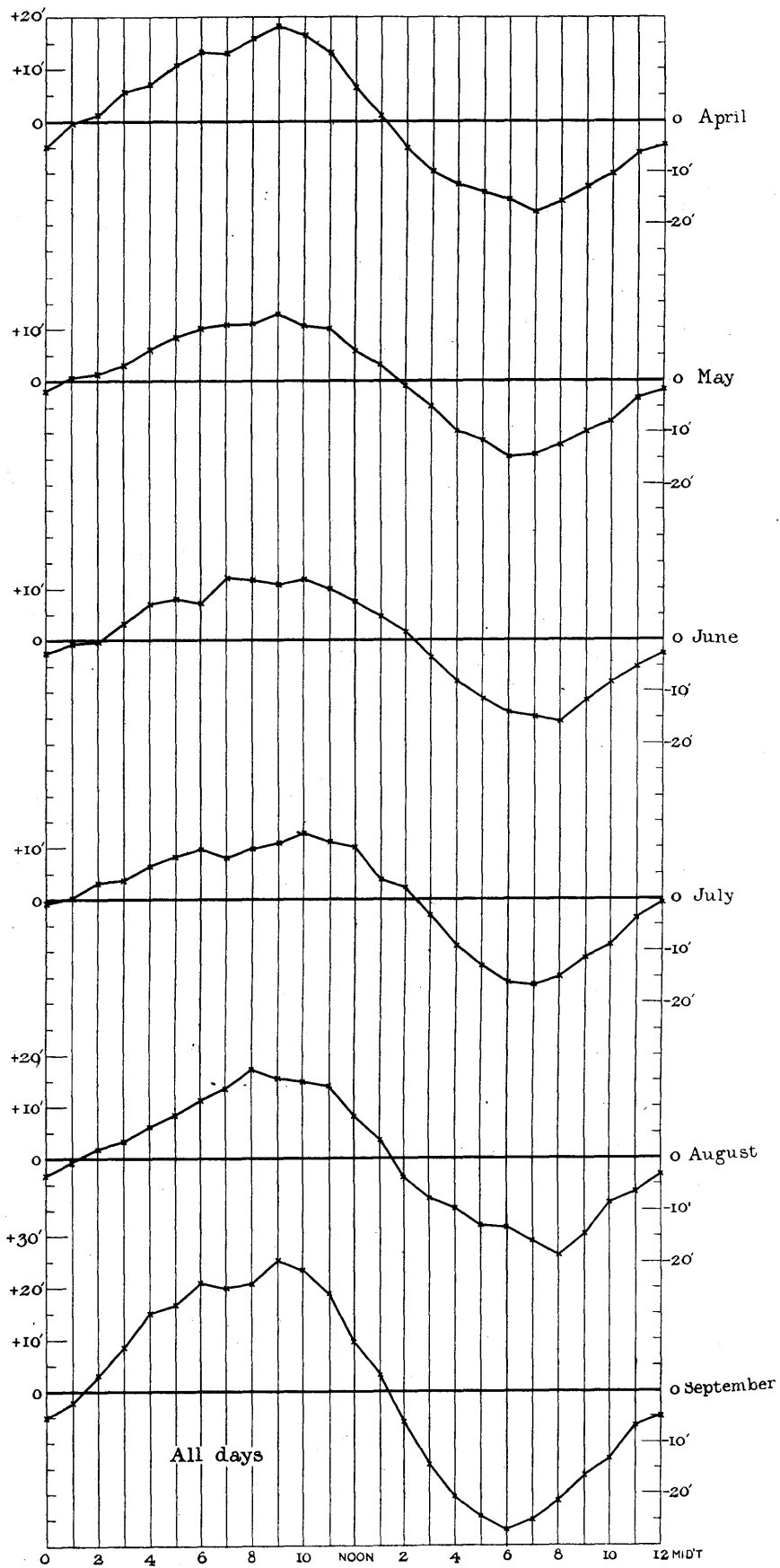

Fig. 2. Declination.

DIURNAL INEQUALITIES.

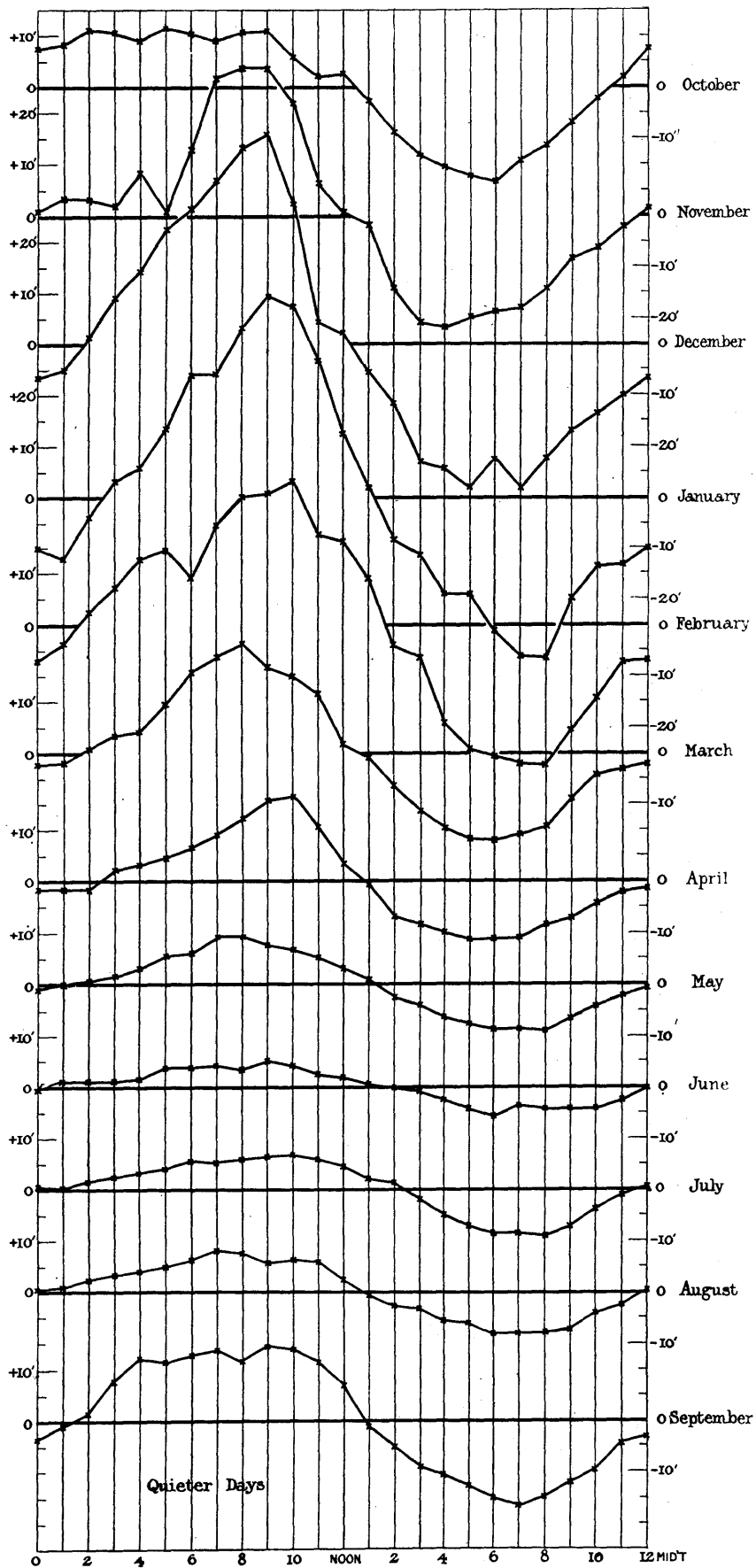

Fig. 3. Declination.

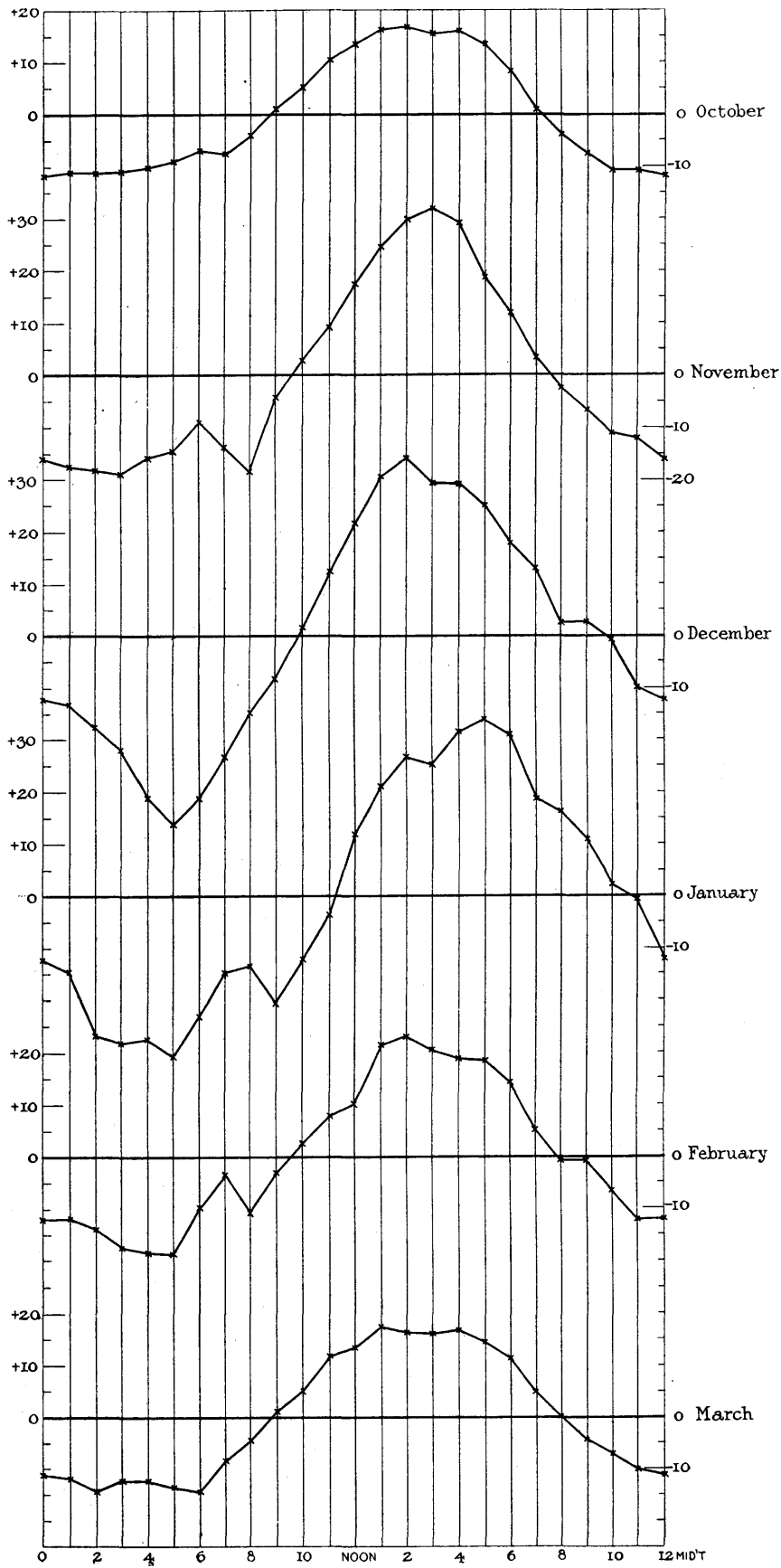

Fig. 4. Horizontal Force. (Unit 1γ.)

DIURNAL INEQUALITIES.

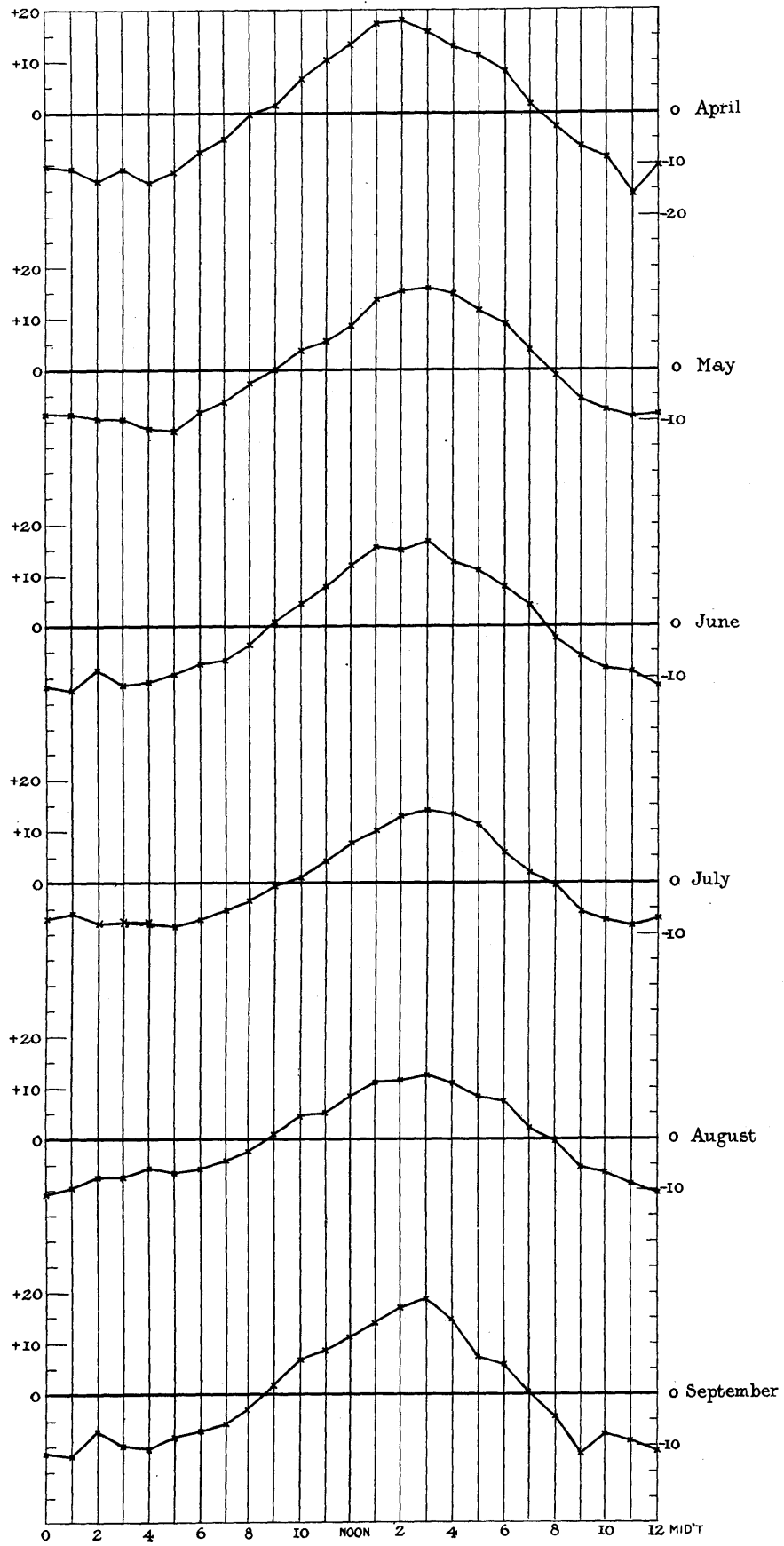

Fig. 5. Horizontal Force. (Unit 1γ.)

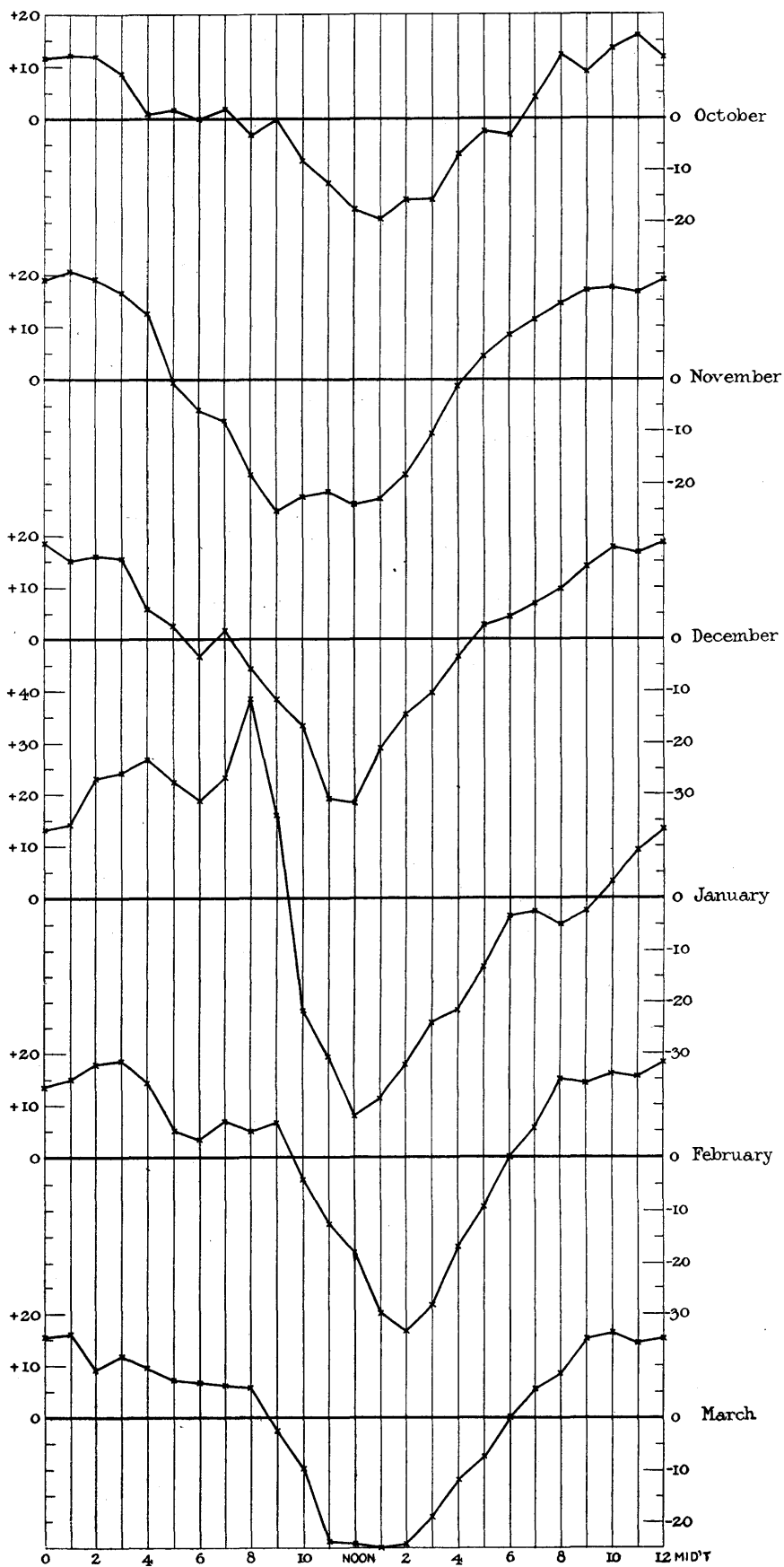

Fig. 6. Vertical Force. (Unit  $1\gamma$ .) \*



DIURNAL INEQUALITIES.

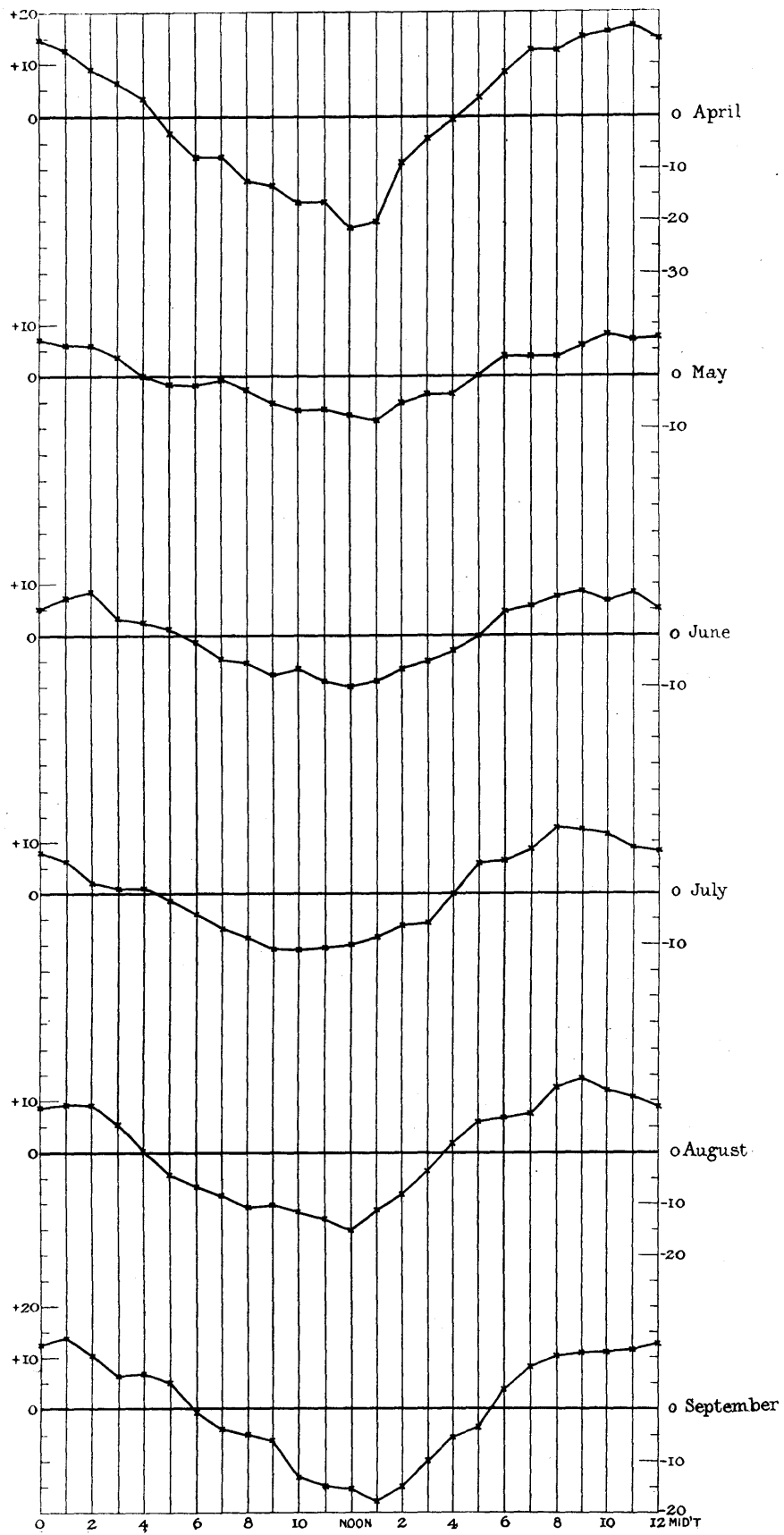

Fig. 7. Vertical Force. (Unit 1γ.)

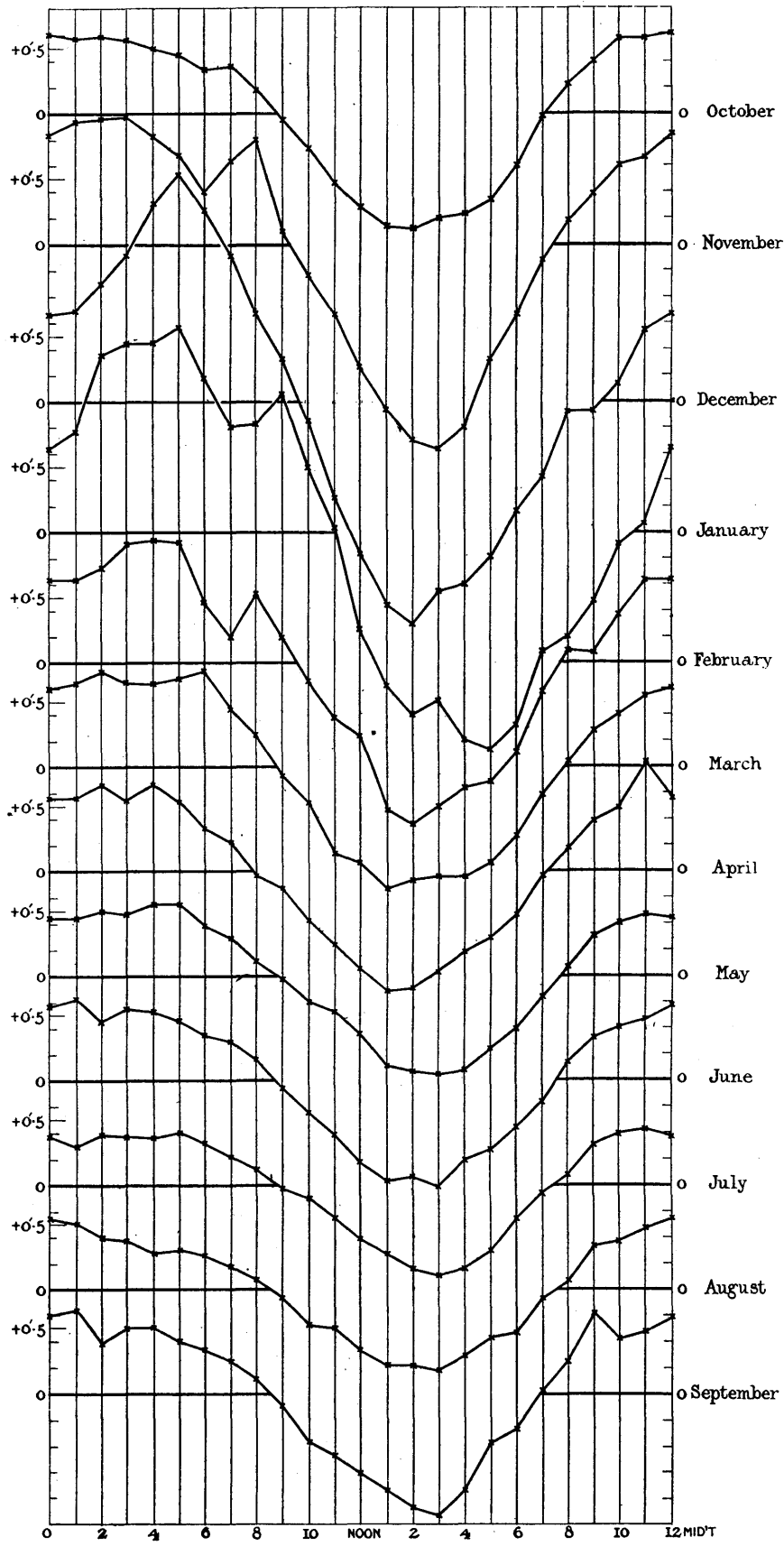

Fig. 8. Inclination.

DIURNAL INEQUALITIES.

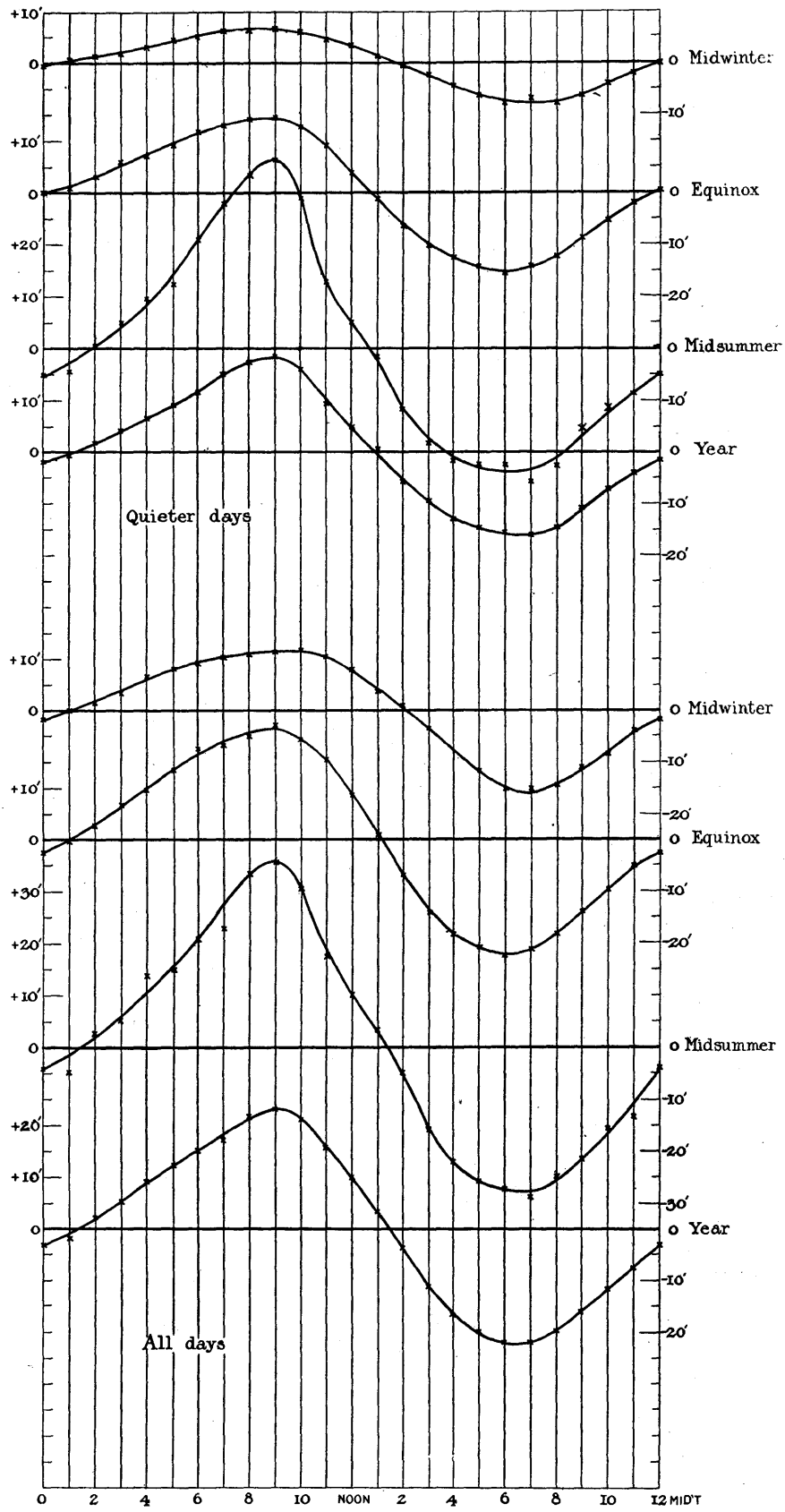

Fig. 9. Declination.

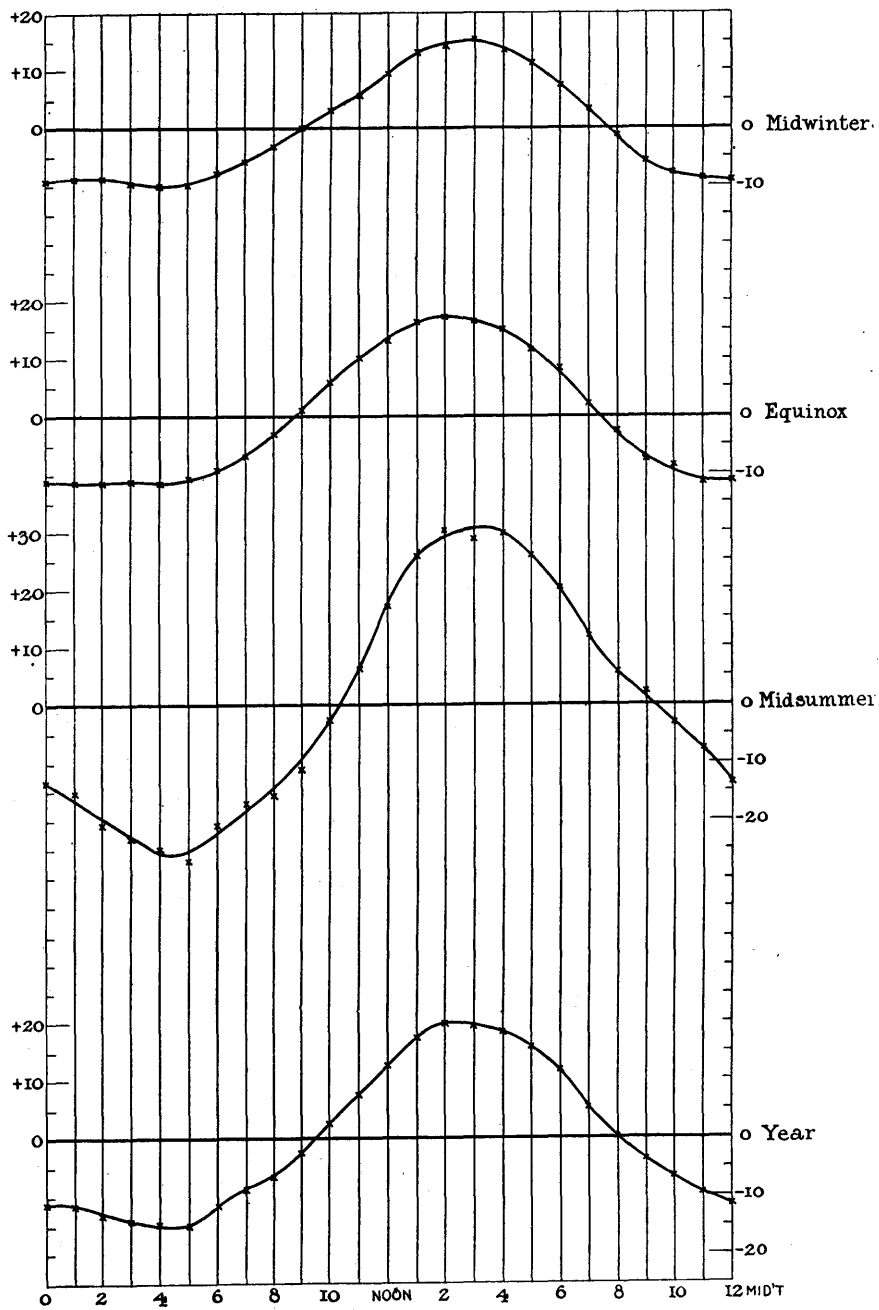

Fig. 10. Horizontal Force. (Unit  $1\gamma$ .)

DIURNAL INEQUALITIES.

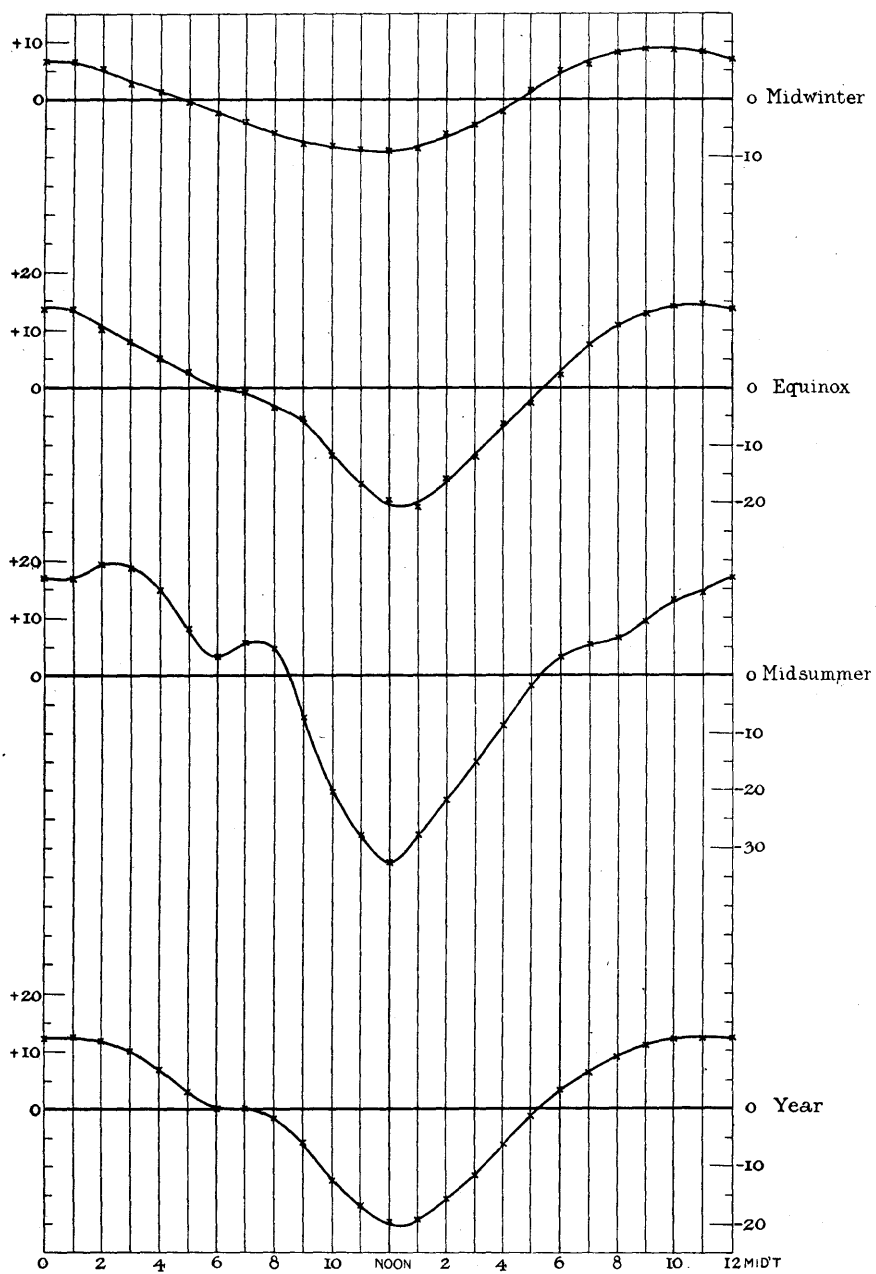

Fig. 11. Vertical Force. (Unit ly.)

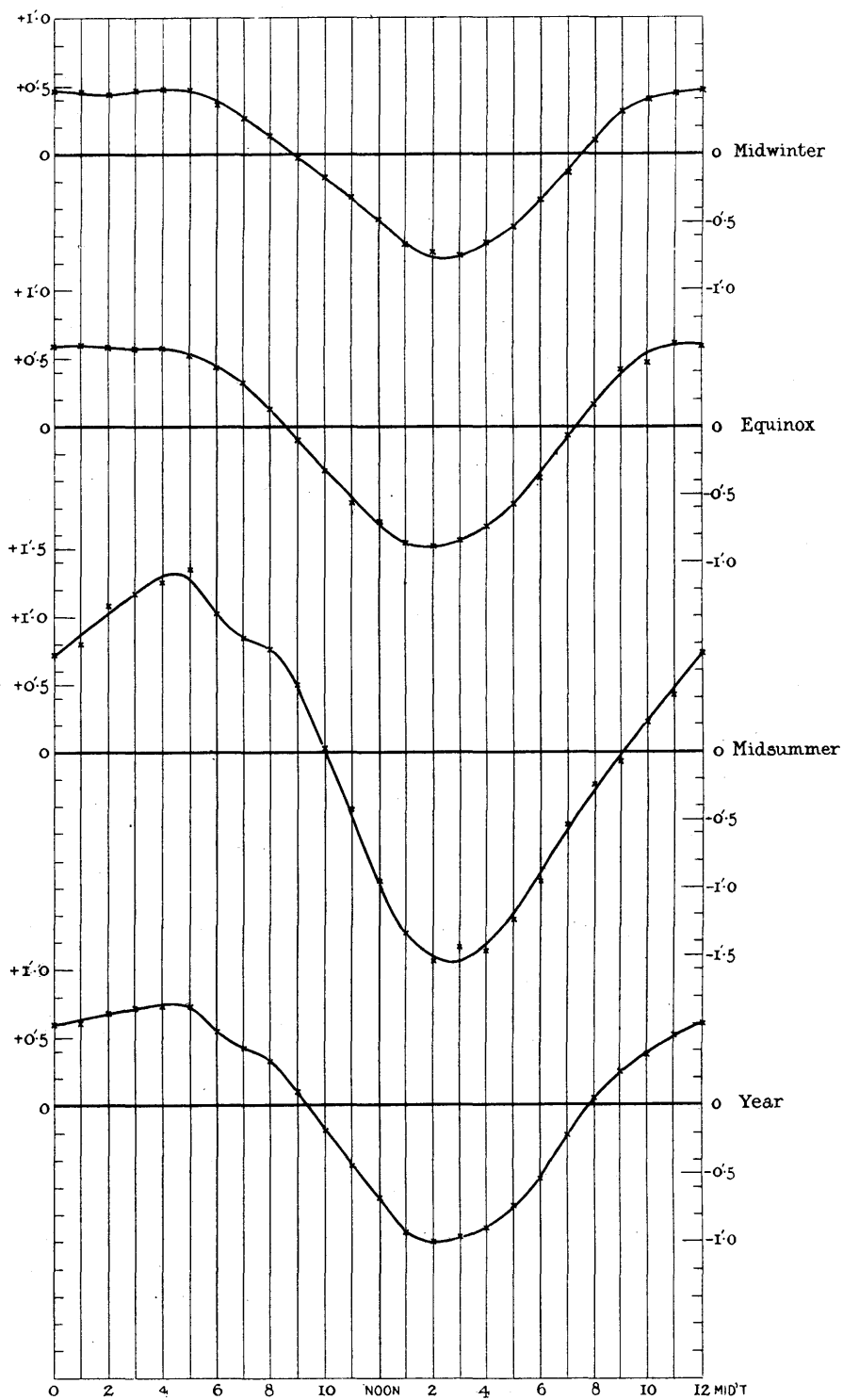

Fig. 12. Inclination.

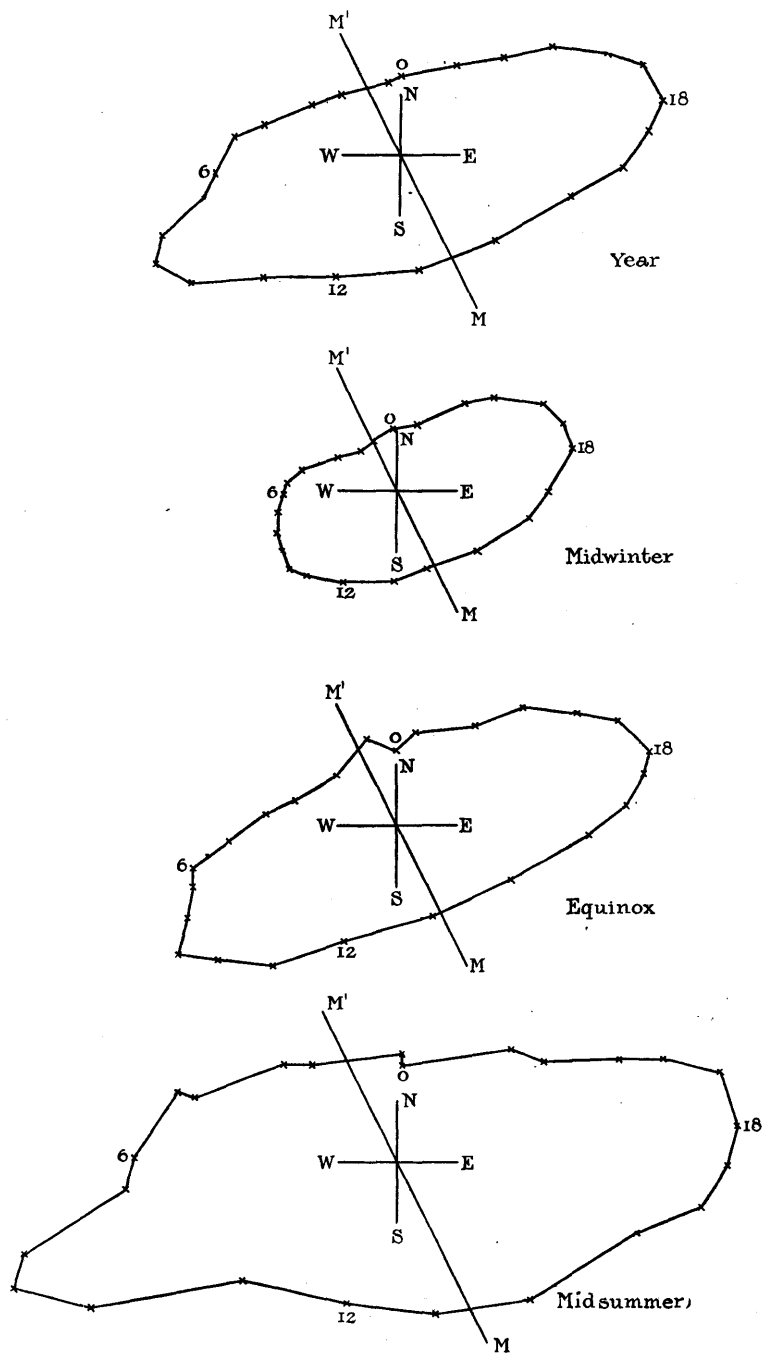

Fig. 13. Vector Diagrams

CHAPTER IV.

DIURNAL INEQUALITIES. FOURIER COEFFICIENTS.

§31. From the diurnal inequalities, calculations were made of the Fourier coefficients answering to the "waves" whose periods are 24, 12, 8 and 6 hours. The analysis of the diurnal inequality may be supposed to proceed according to either of the two equivalent series

$$a_1 \cos t + b_1 \sin t + a_2 \cos 2t + b_2 \sin 2t + \dots$$

$$c_1 \sin (t + \alpha_1) + c_2 \sin (2t + \alpha_2) + \dots$$

Here  $t$  is time, counted from local midnight, one hour being taken as equivalent to  $15^\circ$ . The constants with suffix 1 refer to the 24-hour term, those with suffix 2 to the 12-hour term, and so on. The  $a$  and  $b$  constants are calculated directly from the inequality tables. The mean  $a_1$ , for instance, for a particular season of the year is the arithmetic mean of the values of  $a_1$  for the months composing that season. The  $c$  (amplitude) and  $\alpha$  (phase angle) constants are calculated from the corresponding  $a$  and  $b$  constants by means of the formulæ

$$\alpha = \tan^{-1} (a/b), \quad c = a/\sin \alpha = b/\cos \alpha.$$

The  $c$  (or  $\alpha$ ) derivable from a seasonal diurnal inequality is not, as a rule, the arithmetic mean of the  $c$ 's (or  $\alpha$ 's) of the individual months which form the season.

§32. Tables XXIV to XXXII are devoted to the  $a$  and  $b$  coefficients. These were in all cases really calculated to at least one figure further than is retained. It is, however, hardly necessary to remark that even as thus curtailed they cannot be regarded as physical facts freed from observational uncertainties. This reservation ought especially to be borne in mind in the case of the coefficients with suffixes 3 and 4, which relate to the 8-hour and 6-hour waves. The differences between the values obtained for successive months probably owe at least as much to the existence of "accidental" disturbances as to any real difference between the magnetic conditions characteristic of successive months of an average year.

In the case of the Declination, Horizontal Force and Vertical Force the values of  $a$  and  $b$  are recorded for the individual months of the two years, as well as for the months of a representative year in which common months of 1902 and 1903 are combined. Also two sets of values are given for Declination. Of these the first set, comprising Tables XXIV and XXV, relate to the all-days' inequality data of Tables XII and XIII; while the second set, comprising Tables XXVI and XXVII, relate to the quieter-days' inequality data of Tables XIV and XV. For Inclination only one table is given. When the sign to be attributed to the numerical value of a constant is the same for each month and season it is indicated only at the top and bottom of the column.

TABLE XXIV.—Declination (All Days). Fourier Coefficients. (Unit 1'.)

	$a_1$ .	$b_1$ .	$a_2$ .	$b_2$ .	$a_3$ .	$b_3$ .	$a_4$ .	$b_4$ .
1902								
April . . . . .	-4.47	+12.22	+1.03	-3.37	+0.29	+1.35	+0.10	-0.36
May . . . . .	2.14	8.84	1.55	-0.01	-0.72	-0.87	+0.34	-0.91
June . . . . .	3.91	7.06	2.36	+0.66	+0.83	-0.38	-0.04	-0.52
July . . . . .	3.48	7.38	3.95	+0.12	+0.17	-0.58	+0.32	+0.01
August . . . . .	2.83	8.74	1.88	-1.31	+0.79	+0.77	+0.49	-0.43
September . . . . .	4.15	16.55	1.01	-2.83	+0.76	-1.27	-0.29	+0.12
October . . . . .	2.46	19.17	4.58	-3.46	-0.10	-0.53	+0.13	+0.15
November . . . . .	4.20	22.52	3.90	-4.25	+1.42	+2.08	-3.16	+0.71
December . . . . .	14.60	31.89	2.47	-8.96	+1.24	+2.71	-2.23	+0.83
1903								
January . . . . .	12.19	22.25	2.65	-1.52	+0.75	-1.95	+0.97	-1.87
February . . . . .	14.87	25.28	7.13	-4.85	-0.23	+0.74	-1.59	-0.22
March . . . . .	6.90	20.85	2.17	-5.48	+0.38	+0.22	+0.54	-0.82
April . . . . .	6.82	17.72	2.41	-0.95	-0.06	+0.58	0.00	-1.33
May . . . . .	6.60	13.94	2.98	-1.41	+1.03	-0.24	-0.08	+0.32
June . . . . .	7.55	15.62	2.41	-0.42	-0.05	-1.10	+0.26	-0.29
July . . . . .	6.91	15.95	3.70	+0.74	-0.37	-0.53	-0.05	-1.10
August . . . . .	9.73	17.66	2.68	-3.84	+1.01	-1.62	+0.87	-3.05
September . . . . .	-10.06	+28.86	+5.59	-3.45	-3.08	+0.74	-0.58	-2.56



TABLE XXV.—Declination (All Days). Fourier Coefficients. (Unit 1')

	$a_1$ .	$b_1$ .	$a_2$ .	$b_2$ .	$a_3$ .	$b_3$ .	$a_4$ .	$b_4$ .
January . . . . .	-12·19	+22·25	+2·65	-1·52	+0·75	-1·95	+0·97	-1·87
February . . . . .	14·87	25·28	7·13	-4·85	-0·23	+0·74	-1·59	-0·22
March . . . . .	6·90	20·85	2·17	-5·48	+0·38	+0·22	+0·54	-0·82
April . . . . .	5·65	14·97	1·72	-2·16	+0·12	+0·96	+0·05	-0·84
May . . . . .	4·37	11·39	2·27	-0·71	+0·15	-0·56	+0·13	-0·29
June . . . . .	5·73	11·34	2·39	+0·12	+0·39	-0·74	+0·11	-0·40
July . . . . .	5·19	11·67	3·83	+0·43	-0·10	-0·56	+0·14	-0·55
August . . . . .	6·28	13·20	2·28	-2·57	+0·90	-0·43	+0·68	-1·74
September . . . . .	7·10	22·70	3·30	-3·14	-1·16	-0·26	-0·43	-1·22
October . . . . .	2·46	19·18	4·58	-3·46	-0·10	-0·53	+0·13	+0·15
November . . . . .	4·20	22·52	3·91	-4·25	+1·42	+2·08	-3·16	+0·71
December . . . . .	14·60	31·89	2·46	-8·96	+1·24	+2·71	-2·23	+0·83
Year . . . . .	7·46	18·94	3·22	-3·05	+0·31	+0·14	-0·39	-0·52
Midwinter . . . . .	5·10	11·46	2·83	-0·05	+0·15	-0·62	+0·13	-0·41
Equinox . . . . .	5·53	19·42	2·94	-3·56	-0·19	+0·10	+0·07	-0·68
Midsummer . . . . .	-10·33	+25·55	+3·01	-4·91	+1·13	+0·95	-1·47	-0·11

TABLE XXVI.—Declination (Quieter Days). Fourier Coefficients. (Unit 1')

	$a_1$ .	$b_1$ .	$a_2$ .	$b_2$ .	$a_3$ .	$b_3$ .	$a_4$ .	$b_4$ .
1902								
April . . . . .	-3·32	+8·90	+0·84	-3·96	+0·19	+1·95	-0·30	-0·81
May . . . . .	1·78	5·46	+0·85	-0·30	+0·03	+0·06	+0·50	-0·09
June . . . . .	1·35	3·09	+0·84	-0·49	+0·28	-0·06	-0·18	+0·25
July . . . . .	1·61	4·97	+1·84	-0·18	+0·58	-0·34	+0·12	-0·09
August . . . . .	1·21	5·43	+0·32	-0·78	+0·41	+0·74	+0·30	-0·20
September . . . . .	1·58	12·49	+0·58	-2·72	+0·38	-0·33	-0·26	+0·04
October . . . . .	2·62	13·77	+3·57	-1·04	+0·07	-0·05	+0·01	+0·47
November . . . . .	2·90	19·01	+1·94	-8·45	+3·17	+1·71	-0·91	+1·90
December . . . . .	6·42	28·10	-1·87	-7·29	+2·30	+0·11	-2·01	+0·48
1903								
January . . . . .	14·38	24·98	+2·50	-6·88	+2·17	+1·18	-1·36	-3·20
February . . . . .	10·58	21·81	+5·37	-2·10	-0·06	+0·50	-1·33	-1·05
March . . . . .	4·02	15·37	+1·22	-4·57	+1·25	-1·00	-0·13	+0·06
April . . . . .	4·25	11·51	+2·95	-4·22	+0·68	+0·61	-0·71	-1·38
May . . . . .	3·31	9·89	+1·04	-1·83	+1·41	-0·67	-0·09	+0·14
June . . . . .	1·91	5·13	+0·32	+0·64	+0·05	+0·43	+0·29	+0·24
July . . . . .	3·78	8·21	+2·27	+0·62	+0·33	-0·42	+0·39	-0·47
August . . . . .	2·51	9·02	+1·36	+0·31	+0·75	-0·25	+0·58	-0·14
September . . . . .	-6·83	+16·51	+1·72	+1·13	-1·41	+1·36	+0·39	-3·28

TABLE XXVII.—Declination (Quieter Days). Fourier Coefficients. (Unit 1')

	$a_1$ .	$b_1$ .	$a_2$ .	$b_2$ .	$a_3$ .	$b_3$ .	$a_4$ .	$b_4$ .
January . . . . .	-14.38	+24.93	+2.50	-6.88	+2.17	+1.18	-1.36	-3.29
February . . . . .	10.58	21.81	+5.37	-2.10	-0.06	+0.50	-1.33	-1.05
March . . . . .	4.02	15.37	+1.22	-4.57	+1.25	-1.00	-0.13	+0.06
April . . . . .	3.79	10.20	+1.89	-4.09	+0.44	+1.28	-0.50	-1.10
May . . . . .	2.54	7.67	+0.95	-1.06	+0.72	-0.31	+0.21	+0.03
June . . . . .	1.63	4.11	+0.58	+0.07	+0.17	+0.19	+0.05	+0.24
July . . . . .	2.70	6.59	+2.05	+0.22	+0.46	-0.33	+0.25	-0.28
August . . . . .	1.86	7.23	+0.84	-0.24	+0.53	+0.24	+0.44	-0.17
September . . . . .	4.20	14.50	+1.15	-0.79	-0.52	+0.51	+0.07	-1.62
October . . . . .	2.62	13.77	+3.57	-1.04	+0.07	-0.05	+0.01	+0.47
November . . . . .	2.90	19.01	+1.94	-8.45	+3.17	+1.71	-0.91	+1.90
December . . . . .	6.42	28.10	-1.87	-7.29	+2.30	+0.11	-2.01	+0.48
Year . . . . .	4.80	14.44	+1.68	-3.02	+0.90	+0.33	-0.44	-0.36
Midwinter . . . . .	2.29	6.12	+1.19	-0.26	+0.45	-0.17	+0.17	-0.01
Equinox . . . . .	3.66	13.46	+1.96	-2.62	+0.31	+0.19	-0.14	-0.55
Midsummer . . . . .	-7.90	+24.03	+0.86	-7.54	+2.55	+1.00	-1.43	-0.31

TABLE XXVIII.—Horizontal Force. Fourier Coefficients. (Unit 1y.)

	$a_1$ .	$b_1$ .	$a_2$ .	$b_2$ .	$a_3$ .	$b_3$ .	$a_4$ .	$b_4$ .
1902								
April . . . . .	-12.20	-7.16	+1.55	+4.13	-1.08	+0.84	-0.10	+0.80
May . . . . .	10.33	10.34	-0.30	3.38	+1.35	+0.42	-0.65	+0.97
June . . . . .	8.99	5.83	-0.21	3.53	+0.38	-0.01	+0.46	+0.87
July . . . . .	6.84	4.78	+0.14	3.04	+0.02	-0.37	-0.29	+0.24
August . . . . .	9.23	5.75	+0.41	2.16	+0.23	+0.59	+0.43	-0.12
September . . . . .	12.85	6.26	+1.81	1.98	-0.17	+0.94	+0.05	+0.30
October . . . . .	12.55	7.42	+0.66	3.37	+0.06	+0.67	+0.60	-0.53
November . . . . .	17.08	14.92	+1.07	6.88	-0.04	-2.23	+0.29	-1.46
December . . . . .	16.78	23.67	+6.22	3.59	+0.74	+0.78	-0.67	+1.55
1903								
January . . . . .	10.61	27.48	-1.75	1.76	+1.62	-2.66	+2.66	+1.48
February . . . . .	13.24	12.83	+0.39	2.91	+1.10	-0.77	+0.81	+1.25
March . . . . .	12.58	10.22	+1.19	1.81	-0.16	+1.32	+0.08	-0.43
April . . . . .	14.30	7.44	+0.35	0.19	+1.40	+0.13	+0.67	+1.20
May . . . . .	10.03	5.64	+0.77	1.89	+0.85	+0.93	+0.57	+0.27
June . . . . .	13.59	9.13	+1.20	1.59	-0.68	+0.63	-0.14	-0.71
July . . . . .	9.53	8.27	+0.11	3.11	+1.79	+1.22	+0.13	+0.34
August . . . . .	8.55	5.18	-1.38	2.10	-0.98	+0.55	-1.14	-0.01
September . . . . .	-11.06	-5.64	+0.46	+4.96	+1.81	-0.67	-0.92	-0.74

TABLE XXIX.—Horizontal Force. Fourier Coefficients. (Unit 1γ.)

	$a_1$	$b_1$	$a_2$	$b_2$	$a_3$	$b_3$	$a_4$	$b_4$
January . . . . .	-10·61	-27·48	-1·75	+1·76	+1·62	-2·66	+2·66	+1·48
February . . . . .	13·24	12·83	+0·89	2·91	+1·10	-0·77	+0·81	+1·25
March . . . . .	12·58	10·22	+1·19	1·81	-0·16	+1·32	+0·08	-0·43
April . . . . .	13·25	7·30	+0·95	2·16	+0·16	+0·48	+0·28	+1·00
May . . . . .	10·18	7·99	+0·23	2·63	+1·10	+0·68	-0·04	+0·62
June . . . . .	11·29	7·48	+0·49	2·56	-0·15	+0·31	+0·16	+0·08
July . . . . .	8·18	6·53	+0·13	3·07	+0·90	+0·43	-0·08	+0·29
August . . . . .	8·89	5·43	-0·49	2·13	-0·35	+0·57	-0·35	-0·06
September . . . . .	11·96	5·95	+1·14	3·47	+0·81	+0·14	-0·44	-0·22
October . . . . .	12·55	7·42	+0·66	3·37	+0·06	+0·67	+0·60	-0·53
November . . . . .	17·08	14·92	+1·07	6·88	-0·04	-2·23	+0·29	-1·46
December . . . . .	16·78	23·67	+6·22	3·59	+0·74	+0·78	-0·67	+1·55
Year . . . . .	12·21	11·42	+0·84	3·03	+0·49	-0·03	+0·25	+0·30
Midwinter . . . . .	9·88	7·33	+0·29	2·75	+0·62	+0·47	+0·01	+0·33
Equinox . . . . .	12·58	7·72	+0·98	2·71	+0·22	+0·65	+0·13	-0·05
Midsummer . . . . .	-14·82	-22·02	+1·85	+4·08	+0·77	-1·37	+0·76	+0·52

TABLE XXX.—Vertical Force. Fourier Coefficients. (Unit 1γ.)

	$a_1$	$b_1$	$a_2$	$b_2$	$a_3$	$b_3$	$a_4$	$b_4$
1902								
March . . . . .	+13·18	+ 0·85	- 4·25	-5·19	+2·30	-0·30	-1·12	-0·76
April . . . . .	16·78	- 8·65	- 1·38	0·00	+3·66	+0·13	-0·40	-0·90
May . . . . .	5·62	- 4·00	- 0·25	+2·74	+0·44	-0·52	-0·38	+0·65
June . . . . .	8·05	- 2·20	+ 0·05	-0·92	+0·09	-0·26	-1·61	-0·04
July . . . . .	5·97	- 4·05	- 0·69	-0·16	+0·61	+0·23	+0·07	+0·55
August . . . . .	7·00	- 8·70	- 0·85	+1·72	+0·27	-0·41	-1·07	-0·42
September . . . . .	11·79	- 1·96	- 2·46	+1·22	-0·68	+0·07	-0·40	+1·36
October . . . . .	12·44	+ 0·99	- 3·22	-2·13	+1·15	+0·29	+0·27	+0·56
November . . . . .	22·09	- 5·47	- 2·15	+2·84	-0·37	+1·72	-0·22	-0·45
December . . . . .	19·63	+ 3·20	- 3·49	-1·58	+2·73	+2·62	-1·98	-1·40
1903								
January . . . . .	20·11	+18·89	-11·98	-3·11	+7·34	+1·78	-3·35	+3·29
February . . . . .	17·60	+ 8·02	- 3·34	-6·23	-0·11	+5·65	-1·13	-0·06
March . . . . .	23·00	+ 7·71	- 4·41	-4·63	+2·30	+0·29	-0·97	+1·70
April . . . . .	14·93	- 4·62	- 1·86	-0·55	-0·76	+1·13	-1·74	-0·09
May . . . . .	8·38	+ 1·20	- 0·45	-4·18	+1·19	+1·29	+0·63	+0·14
June . . . . .	8·80	- 2·12	- 1·96	+0·38	-1·05	+1·65	+1·07	+0·59
July . . . . .	12·68	- 7·59	- 2·15	-1·83	-1·73	-0·42	+0·39	-1·31
August . . . . .	16·08	- 3·78	- 1·18	-1·70	+0·53	+2·30	-1·66	+0·15
September . . . . .	16·41	+ 0·49	- 1·52	-3·84	+1·22	+1·78	+0·15	-0·74
October . . . . .	15·28	+ 1·25	+ 1·33	-5·52	+2·21	+2·00	-2·47	-0·13
November . . . . .	21·95	+ 2·81	- 8·70	-8·02	+4·07	+2·99	-0·55	+1·71
December . . . . .	+50·72	+ 9·87	-11·40	+8·38	+1·25	-0·69	-2·78	+3·68

TABLE XXXI.—Vertical Force. Fourier Coefficients. (Unit 1 $\gamma$ .)

	$a_1$ .	$b_1$ .	$a_2$ .	$b_2$ .	$a_3$ .	$b_3$ .	$a_4$ .	$b_4$ .
January . . . . .	+20·11	+18·89	-11·98	-3·11	+7·34	+1·78	-3·35	+3·29
February . . . . .	17·60	+ 8·02	3·34	-6·23	-0·11	+5·65	-1·13	-0·06
March . . . . .	18·09	+ 4·28	4·33	-4·91	+2·30	0·00	-1·04	+0·47
April . . . . .	15·86	- 6·63	1·62	-0·28	+1·45	+0·63	-1·07	-0·49
May . . . . .	7·00	- 1·40	0·35	-0·72	+0·81	+0·39	+0·12	+0·40
June . . . . .	8·43	- 2·16	0·96	-0·27	-0·48	+0·69	-0·27	+0·28
July . . . . .	9·33	- 5·82	1·42	-0·99	-0·56	-0·10	+0·23	-0·38
August . . . . .	11·54	- 6·24	1·01	+0·01	+0·40	+0·94	-1·37	-0·13
September . . . . .	14·10	- 0·73	1·99	-1·31	+0·27	+0·92	-0·13	+0·31
October . . . . .	13·86	+ 1·12	0·94	-3·82	+1·68	+1·15	-1·10	+0·22
November . . . . .	22·07	+ 3·81	3·46	+0·67	+0·52	+1·97	-0·29	-0·02
December . . . . .	25·85	+ 4·53	5·07	+0·41	+2·43	+1·96	-2·14	-0·39
Year . . . . .	15·32	+ 0·85	3·04	-1·71	+1·34	+1·33	-0·96	+0·29
Midwinter . . . . .	8·25	- 3·13	0·91	-0·66	-0·03	+0·33	+0·03	+0·10
Equinox . . . . .	15·48	- 0·45	2·22	-2·58	+1·42	+0·68	-0·84	+0·13
Midsummer . . . . .	+22·67	+ 6·54	- 6·84	-0·68	+3·43	+1·90	-1·92	+0·96

TABLE XXXII.—Inclination. Fourier Coefficients. (Unit 1'.)

	$a_1$ .	$b_1$ .	$a_2$ .	$b_2$ .	$a_3$ .	$b_3$ .	$a_4$ .	$b_4$ .
January . . . . .	+0·595	+1·394	+0·031	-0·098	-0·045	+0·134	-0·142	-0·056
February . . . . .	0·709	0·648	-0·033	0·166	-0·053	+0·062	-0·044	-0·060
March . . . . .	0·680	0·506	-0·076	0·108	+0·018	-0·063	-0·009	+0·023
April . . . . .	0·702	0·319	-0·052	0·104	-0·001	-0·020	-0·018	-0·050
May . . . . .	0·516	0·375	-0·013	0·129	-0·049	-0·030	+0·002	-0·028
June . . . . .	0·576	0·347	-0·028	0·123	+0·005	-0·012	-0·009	-0·003
July . . . . .	0·431	0·285	-0·012	0·151	-0·046	-0·021	+0·005	-0·016
August . . . . .	0·475	0·232	+0·019	0·102	+0·019	-0·023	+0·011	+0·003
September . . . . .	0·632	0·281	-0·063	0·171	-0·038	-0·002	+0·020	+0·012
October . . . . .	0·660	0·359	-0·036	0·178	+0·005	-0·027	-0·033	+0·026
November . . . . .	0·912	0·695	-0·066	0·325	+0·004	+0·115	-0·015	+0·070
December . . . . .	0·914	1·149	-0·319	0·170	-0·024	-0·028	+0·023	-0·076
Year . . . . .	0·650	0·549	-0·054	0·152	-0·017	+0·007	-0·017	-0·013
Midwinter . . . . .	0·508	0·336	-0·018	0·134	-0·030	-0·021	-0·001	-0·015
Equinox . . . . .	0·669	0·366	-0·057	0·140	-0·004	-0·028	-0·010	+0·003
Midsummer . . . . .	+0·807	+1·079	-0·118	-0·198	-0·022	+0·074	-0·045	-0·021

§33. Tables XXXIII to XL are devoted to the  $c$  and  $\alpha$  (amplitude and phase angle) Fourier coefficients in the diurnal inequality as derived from the  $a$  and  $b$  coefficients in Tables XXIV to XXXII. The tables correspond in pairs, except that there is no  $c$ ,  $\alpha$  table for Vertical Force corresponding to Table XXX. If the phase angle  $\alpha$  varies much throughout the year, the contributions from the individual 12 months to the mean diurnal inequality for the whole year tend to neutralise one another, and so the amplitude of the mean inequality for the year is apt to suggest that the corresponding wave is smaller throughout the year than it actually is. Some writers thus prefer the arithmetic mean of the  $c$ 's and  $\alpha$ 's from the 12 monthly data for a particular wave to the corresponding results from the mean diurnal inequality of the whole year. This is the reason why Tables XXXIV, XXXVI, XXXVIII, XXXIX, and XL contain

arithmetic means in addition to the values of  $c$  and  $\alpha$  derived from the mean diurnal inequality for the year. A warning may, however, be not superfluous to the effect that in individual months "accidental" irregularities are apt to influence largely the amplitude and phase angle of the Fourier waves of shorter period. When one derives a diurnal inequality by combining together the months forming a season or the year, these "accidental" effects tend to neutralise one another and disappear, but they do not do so in the case of an arithmetic mean of amplitudes derived from individual months. The arithmetic mean of the  $c$ 's from the 12 months is necessarily larger than (or at least not less than) the  $c$  assigned in the tables to the "year" (*i.e.* to the  $c$  derived from the mean diurnal inequality for the year). The difference between the two  $c$ 's is greater the more variable the phase angle throughout the year. The variation from month to month in the phase angles in the tables is partly, no doubt, natural (*i.e.* representative of the average of years), but it undoubtedly arises in part from "accidental" disturbances and from observational uncertainties. The "accidental" phenomena are especially apt to influence the waves of shorter period, and this is no doubt partly the reason why the values of  $c$  derived from the arithmetic mean of the 12 monthly values and from the mean diurnal inequality for the year are relatively so much closer for the 24-hour wave than for the others. In the case of the shorter-period waves an arithmetic mean could not in all cases be assigned for the phase angle. Provided this angle varies slowly and regularly throughout the year, if we get, say,  $359^\circ$  and  $1^\circ$  as its values in two consecutive months, we know that we must regard these either as  $359^\circ$  and  $361^\circ$ , or as  $-1^\circ$  and  $+1^\circ$ , in forming a mean. But when, as in Table XXXIV, the values in three successive months are  $200^\circ$ ,  $40^\circ$ , and  $-77^\circ$ , it is by no means clear how best to interpret the figures.

The phase angles were all calculated out to the nearest minute, though none of them can really claim that degree of accuracy. The phase angles for the 24-hour wave are shown as calculated; for the 12-hour wave decimals of a degree are retained; for the 8-hour and 6-hour waves the results are recorded only to the nearest degree. In all cases local time is used, Midnight answering to  $t = 0$ . Declination, it will be remembered, is counted positive when the angle  $n_0N$  of the figure on p. 101 is above its mean value for the day; while inclination is regarded as increasing when the needle approaches the vertical.

An increase in a phase angle means that the maxima and minima of the corresponding wave occur earlier in the day. An advance of 1 hour in time requires an increase of  $15^\circ$  in  $\alpha_1$ , of  $30^\circ$  in  $\alpha_2$ , of  $45^\circ$  in  $\alpha_3$ , and of  $60^\circ$  in  $\alpha_4$ .

TABLE XXXIII.—Declination (All Days). Amplitudes (Unit 1') and Phase Angles.

	$c_1$	$\alpha_1$	$c_2$	$\alpha_2$	$c_3$	$\alpha_3$	$c_4$	$\alpha_4$
1902		° /		°		°		°
April . . . . .	13·01	339 55	3·52	163·1	1·38	12	0·38	165
May . . . . .	9·09	346 23	1·55	90·4	1·14	220	0·97	159
June . . . . .	8·07	331 2	2·45	74·3	0·91	114	0·52	185
July . . . . .	8·16	334 47	3·95	88·2	0·61	164	1·44	13
August . . . . .	9·19	342 2	2·29	124·9	1·10	46	0·65	131
September . . . . .	17·06	345 55	3·00	160·4	1·48	149	0·31	- 67
October . . . . .	19·34	352 42	5·73	127·0	0·54	191	0·20	40
November . . . . .	22·92	349 26	5·77	137·4	2·52	34	3·24	- 77
December . . . . .	35·08	335 24	9·29	164·6	2·98	25	2·38	- 70
1903								
January . . . . .	25·36	331 17	3·05	119·8	2·09	159	2·11	153
February . . . . .	29·34	329 32	8·62	124·3	0·78	- 17	1·60	262
March . . . . .	21·95	341 41	5·89	153·4	0·44	60	0·99	147
April . . . . .	21·31	338 57	2·59	111·4	0·58	- 6	1·33	180
May . . . . .	15·42	334 39	3·30	115·4	1·06	103	0·33	- 14
June . . . . .	17·35	334 11	2·45	100·0	1·10	183	0·39	133
July . . . . .	17·39	336 35	3·78	78·7	0·65	215	1·10	182
August . . . . .	20·17	331 9	4·68	145·0	1·91	148	3·18	164
September . . . . .	30·56	340 47	6·56	121·6	3·17	- 76	2·63	193

TABLE XXXIV.—Declination (All Days). Amplitudes (Unit 1') and Phase Angles.

	$c_1$ .	$\alpha_1$ .	$c_2$ .	$\alpha_2$ .	$c_3$ .	$\alpha_3$ .	$c_4$ .	$\alpha_4$ .
		° /		°		°		°
January . . . . .	25·36	331 17	3·05	119·8	2·09	159	2·11	153
February . . . . .	29·34	329 32	8·62	124·3	0·78	- 17	1·60	262
March . . . . .	21·95	341 41	5·89	158·4	0·44	60	0·99	147
April . . . . .	16·00	339 20	2·76	141·5	0·97	7	0·85	177
May . . . . .	12·20	339 0	2·38	107·5	0·58	165	0·32	156
June . . . . .	12·71	333 11	2·39	87·1	0·83	152	0·42	165
July . . . . .	12·77	336 0	3·85	83·5	0·56	191	0·56	166
August . . . . .	14·62	334 33	3·44	138·4	1·00	115	1·87	159
September . . . . .	23·78	342 37	4·55	133·6	1·19	257	1·30	200
October . . . . .	19·34	352 42	5·73	127·0	0·54	191	0·20	40
November . . . . .	22·92	349 26	5·77	137·4	2·52	34	3·24	- 77
December . . . . .	35·08	335 24	9·29	164·6	2·98	25	2·38	- 70
Arithmetic means . . . . .	20·51	338 44	4·81	126·9	1·21	111·6	1·32	123·2
Year . . . . .	20·36	338 29	4·43	133·4	0·34	66	0·65	217
Midwinter . . . . .	12·55	336 1	2·83	91·1	0·63	167	0·43	163
Equinox . . . . .	20·20	344 7	4·62	140·4	0·21	297	0·69	174
Midsummer . . . . .	27·55	337 59	5·75	143·5	1·48	50	1·48	266

TABLE XXXV.—Declination (Quieter Days). Amplitudes (Unit 1') and Phase Angles.

	$c_1$ .	$\alpha_1$ .	$c_2$ .	$\alpha_2$ .	$c_3$ .	$\alpha_3$ .	$c_4$ .	$\alpha_4$ .
		° /		°		°		°
1902								
April . . . . .	9·50	339 31	4·05	168·0	1·96	6	0·87	200
May . . . . .	5·74	342 5	0·90	109·3	0·07	23	0·51	101
June . . . . .	3·37	336 29	0·97	120·4	0·29	101	0·31	- 37
July . . . . .	5·22	342 2	1·85	95·7	0·67	120	0·15	128
August . . . . .	5·57	347 27	0·84	157·9	0·84	29	0·36	124
September . . . . .	12·59	352 48	2·78	167·9	0·50	131	0·26	- 81
October . . . . .	14·02	370 47	3·71	106·2	0·09	123	0·47	1
November . . . . .	19·21	351 20	8·67	167·1	3·61	62	2·11	- 26
December . . . . .	28·83	347 8	7·52	194·4	2·31	87	2·06	- 77
1903								
January . . . . .	28·83	330 5	7·32	160·0	2·47	62	3·56	202
February . . . . .	24·24	334 7	5·76	111·3	0·50	- 7	1·69	231
March . . . . .	15·89	345 21	4·73	165·0	1·61	129	0·15	- 66
April . . . . .	12·27	339 44	5·14	145·0	0·92	48	1·55	207
May . . . . .	10·43	341 29	2·11	150·4	1·56	116	0·17	- 33
June . . . . .	5·47	339 33	0·71	26·4	0·44	7	0·37	50
July . . . . .	9·04	335 15	2·36	74·8	0·53	142	0·61	140
August . . . . .	9·36	344 26	1·40	77·1	0·79	109	0·60	104
September . . . . .	17·86	337 31	2·06	56·6	1·96	- 46	3·31	173

TABLE XXXVI.—Declination (Quieter Days). Amplitudes (Unit 1') and Phase Angles.

	$c_1$ .	$\alpha_1$ .	$c_2$ .	$\alpha_2$ .	$c_3$ .	$\alpha_3$ .	$c_4$ .	$\alpha_4$ .
		° /		°		°		°
January . . . . .	28·83	330 5	7·32	160·0	2·47	62	3·56	202
February . . . . .	24·24	334 7	5·76	111·3	0·50	- 7	1·69	231
March . . . . .	15·89	345 21	4·73	165·0	1·61	129	0·15	- 66
April . . . . .	10·88	339 38	4·50	155·1	1·35	19	1·21	205
May . . . . .	8·08	341 41	1·42	138·4	0·78	113	0·21	83
June . . . . .	4·43	338 24	0·58	82·7	0·25	42	0·25	12
July . . . . .	7·12	337 44	2·07	84·0	0·59	130	0·38	138
August . . . . .	7·46	345 33	0·87	105·6	0·63	67	0·47	111
September . . . . .	15·10	343 50	1·40	124·6	0·73	135	1·62	178
October . . . . .	14·02	370 47	3·71	106·2	0·09	128	0·47	1
November . . . . .	19·21	351 20	8·67	167·1	3·61	62	2·11	- 26
December . . . . .	28·83	347 8	7·52	194·4	2·31	87	2·06	- 77
Arithmetic means . . . . .	15·34	343 48	4·05	132·9	1·24	81	1·18	—
Year . . . . .	15·22	341 36	3·45	150·9	0·96	70	0·57	230
Midwinter . . . . .	6·54	339 31	1·22	102·2	0·48	110	0·17	92
Equinox . . . . .	13·95	344 48	3·27	143·2	0·36	59	0·57	194
Midsummer . . . . .	25·29	341 48	7·59	173·5	2·74	69	1·46	258

TABLE XXXVII.—Horizontal Force. Amplitudes (Unit 1 $\gamma$ ) and Phase Angles.

	$c_1$ .	$\alpha_1$ .	$c_2$ .	$\alpha_2$ .	$c_3$ .	$\alpha_3$ .	$c_4$ .	$\alpha_4$ .
		° /		°		°		°
1902								
April . . . . .	14·15	239 36	4·41	20·5	1·37	- 52	0·81	- 7
May . . . . .	14·62	224 58	3·39	- 5·1	1·42	73	1·16	- 34
June . . . . .	10·72	237 2	3·53	- 3·4	0·38	92	0·99	28
July . . . . .	8·35	235 2	3·04	2·7	0·37	177	0·38	- 50
August . . . . .	10·87	238 5	2·20	10·7	0·66	25	0·45	105
September . . . . .	14·29	244 2	2·68	42·4	0·96	- 11	0·30	9
October . . . . .	14·58	239 24	3·44	11·1	0·67	5	0·76	131
November . . . . .	22·67	228 52	6·97	8·9	2·23	181	1·49	169
December . . . . .	29·01	215 20	7·18	60·0	1·07	43	1·69	- 23
1903								
January . . . . .	29·45	201 7	2·48	-44·9	3·11	149	3·05	61
February . . . . .	18·44	225 54	2·94	7·6	1·34	125	1·49	33
March . . . . .	16·21	230 54	2·17	33·2	1·33	- 7	0·44	169
April . . . . .	16·12	242 32	0·40	61·0	1·41	85	1·37	29
May . . . . .	11·50	240 39	2·04	22·1	1·26	42	0·63	65
June . . . . .	16·37	236 7	1·99	37·1	0·93	- 47	0·72	191
July . . . . .	12·61	229 3	3·11	2·1	2·16	56	0·36	21
August . . . . .	9·99	238 48	2·52	-33·3	1·13	- 61	1·14	269
September . . . . .	12·42	242 58	4·98	5·3	1·93	110	1·18	231

TABLE XXXVIII.—Horizontal Force. Amplitudes (Unit  $1\gamma$ ) and Phase Angles.

	$c_1$ .	$\alpha_1$ .	$c_2$ .	$\alpha_2$ .	$c_3$ .	$\alpha_3$ .	$c_4$ .	$\alpha_4$ .
		° /		°		°		°
January . . . . .	29·45	201 7	2·48	-44·9	3·11	149	3·05	61
February . . . . .	18·44	225 54	2·94	7·6	1·34	125	1·49	33
March . . . . .	16·21	230 54	2·17	33·2	1·33	- 7	0·44	169
April . . . . .	15·13	241 9	2·36	23·6	0·51	18	1·04	16
May . . . . .	12·94	231 52	2·64	5·1	1·29	58	0·62	- 4
June . . . . .	13·54	236 29	2·60	10·9	0·34	- 26	0·18	63
July . . . . .	10·47	231 26	3·08	2·4	1·00	65	0·30	- 16
August . . . . .	10·42	238 34	2·19	-12·8	0·67	- 32	0·36	260
September . . . . .	13·35	243 33	3·65	18·1	0·83	81	0·49	243
October . . . . .	14·58	239 24	3·44	11·0	0·67	5	0·76	131
November . . . . .	22·67	228 52	6·97	8·9	2·23	181	1·49	169
December . . . . .	29·01	215 20	7·18	60·0	1·07	43	1·69	- 23
Arithmetic Means .	17·19	230 23	3·47	10·3	1·20	55	0·99	92
Year . . . . .	16·72	226 54	3·14	15·5	0·49	93	0·39	40
Midwinter . . . . .	12·31	233 26	2·77	5·9	0·78	53	0·72	2
Equinox . . . . .	14·76	233 28	2·88	19·9	0·69	19	0·14	109
Midsummer . . . . .	26·55	213 56	4·47	24·4	1·57	150	0·92	55

TABLE XXXIX.—Vertical Force. Amplitudes (Unit  $1\gamma$ ) and Phase Angles.

	$c_1$ .	$\alpha_1$ .	$c_2$ .	$\alpha_2$ .	$c_3$ .	$\alpha_3$ .	$c_4$ .	$\alpha_4$ .
		° /		°		°		°
January . . . . .	27·59	46 47	12·37	255·4	7·55	76	4·70	314
February . . . . .	19·34	65 29	7·07	208·2	5·66	- 1	1·13	267
March . . . . .	18·59	76 42	6·55	221·4	2·30	90	0·01	294
April . . . . .	17·19	112 42	1·64	260·4	1·58	67	1·18	245
May . . . . .	7·14	101 17	0·80	206·0	0·90	65	0·42	17
June . . . . .	8·70	104 24	0·99	254·3	0·84	- 35	0·39	316
July . . . . .	11·00	121 58	1·73	235·0	0·57	260	0·44	149
August . . . . .	13·12	118 24	1·01	270·4	1·03	23	1·38	264
September . . . . .	14·12	92 58	2·38	236·7	0·96	16	0·33	333
October . . . . .	13·91	85 24	3·94	193·9	2·03	56	1·13	281
November . . . . .	22·39	99 48	3·53	280·9	2·04	15	0·29	266
December . . . . .	26·24	80 3	5·09	274·7	3·12	51	2·17	260
Arithmetic Means .	16·61	92 10	3·92	241·4	2·38	57	1·13	251
Year . . . . .	15·34	86 52	3·49	240·6	1·89	45	1·00	287
Midwinter . . . . .	8·83	110 46	1·12	234·0	0·34	- 13	0·10	16
Equinox . . . . .	15·48	91 49	3·40	220·7	1·58	65	0·85	279
Midsummer . . . . .	23·59	73 55	6·87	264·3	3·92	61	2·15	296



TABLE XL.—Inclination. Amplitudes (Unit 1') and Phase Angles.

	$c_1$ .	$\alpha_1$ .	$c_2$ .	$\alpha_2$ .	$c_3$ .	$\alpha_3$ .	$c_4$ .	$\alpha_4$ .
		° /		°		°		°
January . . . . .	1·515	23 6	0·102	162·5	0·142	341	0·152	248
February . . . . .	0·961	47 36	0·170	191·3	0·081	319	0·074	216
March . . . . .	0·848	53 19	0·132	215·0	0·066	164	0·024	339
April . . . . .	0·771	65 34	0·117	206·6	0·020	183	0·053	200
May . . . . .	0·638	54 1	0·130	185·6	0·058	238	0·028	175
June . . . . .	0·673	58 54	0·126	192·7	0·013	156	0·009	252
July . . . . .	0·517	56 30	0·152	184·7	0·050	246	0·016	163
August . . . . .	0·528	64 0	0·103	169·6	0·030	141	0·011	77
September . . . . .	0·692	66 5	0·182	200·2	0·038	267	0·024	59
October . . . . .	0·751	61 27	0·181	191·3	0·027	170	0·042	308
November . . . . .	1·146	52 42	0·332	191·6	0·115	2	0·071	348
December . . . . .	1·469	38 30	0·361	242·0	0·038	221	0·079	163
Arithmetic means . . . . .	0·876	53 29	0·174	194·4	0·056	204	0·049	212
Year . . . . .	0·851	49 49	0·161	199·6	0·019	292	0·022	234
Midwinter . . . . .	0·609	56 31	0·135	187·5	0·036	235	0·015	182
Equinox . . . . .	0·762	61 17	0·151	201·9	0·028	188	0·010	286
Midsummer . . . . .	1·347	36 47	0·230	210·9	0·077	344	0·049	245

§34. Before making some general remarks on Tables XXXIII to XL, it is convenient to deal with an interesting result deducible from the Declination Tables. If we compare Tables XXXIII and XXXV, or XXXIV and XXXVI, it will be observed that the differences between the phase angles derived from all days and from the quieter days are to some extent systematic, at least in the case of the 24-hour and 12-hour waves.

This will be more easily recognised on consulting Tables XLI and XLII, which show the algebraic excess of the phase angle from the quieter-days' inequality over that from all days. Thus, taking Table XLI, we find the quieter-days' value of  $\alpha_1$  the larger in 13 months out of 18, the average excess for the 18 months being no less than  $4^\circ 29'$ . This signifies that on the average quieter day the maximum and minimum of the 24-hour wave occurred about 18 minutes earlier than on the average day for which records existed. The quieter-days' phase angle  $\alpha_2$  is also the larger in a substantial majority of the months; the average excess is, however, only  $2^\circ 42'$ , representing about 5·4 minutes of time. The excess would, however, have been very substantially larger but for the results from the later months of 1903, which are based on a rather smaller number of days than usual. The results from the seasonal and mean annual diurnal inequalities in Table XLII point in the same direction. The yearly results in this table for  $\alpha_3$  and  $\alpha_4$  have the same sign as those for  $\alpha_1$  and  $\alpha_2$ , but the phenomena in individual months, and even in individual seasons of the year, appear too irregular to justify our regarding the difference between all and quieter days as established for the 8-hour and 6-hour waves.

In the case of the 24-hour and 12-hour waves the difference does seem fairly established. As to its most probable size, if we take a mean from the yearly results in Table XLII and the final means in Table XLI, we find for the advance in quieter days in the time of maximum or minimum 15·2 minutes for the 24-hour wave and 20·2 minutes for the 12-hour wave.

This is not the first occasion on which a difference has been noted between the phase angles on ordinary and on quiet days. Recently\* it was pointed out that a substantial difference existed at Kew between the 24-hour and 12-hour phase angles derived from the Astronomer Royal's quiet days and those derived from all days of the month. There is, however, a certain remarkable difference between the Antarctic phenomena and those at Kew. In the Antarctic we have found the quieter-days' angles to be the larger, both for the 24-hour and the 12-hour waves; but at Kew, while the quieter-days' phase angle was the larger in the case of the 12-hour wave, it was the smaller in the case of the 24-hour wave.

\* 'Phil. Trans.,' A, vol. 208, 1908, pp. 223, &c.

When discussing the Kew results, I hazarded the remark that the difference observed there between the phenomena in the 24-hour and 12-hour waves might be associated with the further difference that the 12-hour phase angle is largest in Summer, while the 24-hour phase angle is largest in Winter. Referring to Tables XXXIV and XXXVI, it will be seen that in the Antarctic, the 24-hour phase angle agrees with the 12-hour phase angle there and at Kew in being larger at Midsummer than at Midwinter. This is, of course, in accordance with the suggestion which I threw out, but much weight ought not to be attached to what not unlikely may be a mere coincidence, especially as the seasonal variation of  $\alpha_1$  in the Antarctic is not large.

The difference of phase is not the only difference between all- and quieter-days' Declination results. The amplitudes, at least in the case of the 24-hour wave, are markedly less for the quieter days, but this we could have foreseen from simple comparison of the diurnal inequalities in Tables XIII and XV.

TABLE XLI.—Declination. Quieter-days' Phase Angle - All-days' Angle.

	$\alpha_1$ .			$\alpha_2$ .		
	1902.	1903.	1902-3.	1902.	1903.	1902-3.
	° /	° /	° /	° /	° /	° /
January . . . . .		- 1 12			+ 40 12	
February . . . . .		+ 4 35			-12 55	
March . . . . .		+ 3 40			+ 6 36	
April . . . . .	- 0 24	+ 0 47	+ 0 18	+ 4 57	+33 39	+13 36
May . . . . .	- 4 18	+ 6 50	+ 2 41	+18 52	+35 2	+30 58
June . . . . .	+ 5 27	+ 5 22	+ 5 13	+46 5	-73 36	- 4 25
July . . . . .	+ 7 15	- 1 20	+ 1 44	+ 7 31	- 3 51	+ 0 26
August . . . . .	+ 5 25	+13 17	+11 0	+32 53	-67 57	-32 49
September . . . . .	+ 6 53	- 3 16	+ 1 13	+ 7 33	-65 2	- 9 0
October . . . . .	+18 5			-20 49		
November . . . . .	+ 1 54			+29 40		
December . . . . .	+11 44			+29 46		
Mean from 18 months . . . . .	+ 4° 29'			+ 2° 42'		

TABLE XLII.—Declination. Quieter-days' Phase Angle - All-days' Angle.

	$\alpha_1$ .	$\alpha_2$ .	$\alpha_3$ .	$\alpha_4$ .
	° /	° /	° /	° /
Year . . . . .	+ 3 7	+17 29	+ 4 4	+13 32
Midwinter . . . . .	+ 3 30	+11 9	- 56 20	-71 24
Equinox . . . . .	+ 0 41	+ 2 49	+122 5	+20 20
Midsummer . . . . .	+ 3 49	+25 1	+ 18 28	- 7 48

§35. The most consistent and striking phenomenon in Tables XXXIII to XL is the relatively small amplitude of the Fourier waves of shorter period as compared to the 24-hour wave. To bring this out more clearly, Table XLIII records the ratios of the amplitudes of the 12-, 8- and 6-hour waves to the corresponding amplitude of the 24-hour wave in the diurnal inequalities for the several elements and seasons. D' relates to the quieter-days', D to the all-days' Declination results. The ratios of the arithmetic means of the 12 monthly values of  $c_2$ ,  $c_3$ , and  $c_4$  to the corresponding mean for  $c_1$  are also given. The figures in the sixth row are means derived from the four elements D, H, V and I. For contrast, the seventh row gives corresponding results from the Kew Declination on ordinary days.

Comparing the results under the heading "Year," we see that relative to the 24-hour wave the importance of the 12-hour and 6-hour waves is, in the Antarctic, only about a third of what it is at Kew, while the relative importance of the 8-hour wave in the Antarctic is only about a sixth of that at Kew.

Taking means from the four elements, we should infer that in the Antarctic the relative importance of the 12- to the 24-hour wave is but little dependent on the season of the year. The 8-hour and 6-hour waves seem, however, of greatest relative importance at Midsummer, which is the exact opposite of what occurs at Kew.

TABLE XLIII.—Ratios of the Amplitudes of the 12-, 8- and 6-hour Fourier Waves to that of the 24-hour Wave.

	$c_2/c_1$ .					$c_3/c_1$ .					$c_4/c_1$ .				
	Ams.	Year.	Mid-winter.	Equinox.	Mid-summer.	Ams.	Year.	Mid-winter.	Equinox.	Mid-summer.	Ams.	Year.	Mid-winter.	Equinox.	Mid-summer.
D'	0·264	0·227	0·187	0·234	0·300	0·081	0·063	0·073	0·026	0·108	0·077	0·037	0·026	0·041	0·058
D	·235	·218	·226	·229	·209	·059	·017	·050	·010	·054	·064	·032	·034	·034	·054
H	·200	·186	·225	·195	·169	·069	·029	·063	·047	·059	·058	·023	·058	·009	·035
V	·236	·227	·127	·220	·291	·143	·123	·038	·102	·166	·068	·065	·012	·055	·091
I	·197	·188	·222	·199	·171	·064	·022	·060	·037	·057	·056	·025	·025	·013	·037
Mean	0·217	0·205	0·200	0·211	0·210	0·084	0·048	0·053	0·049	0·084	0·061	0·036	0·032	0·028	0·054
Kew D	—	0·62	0·49	0·65	0·65	—	0·28	0·23	0·34	0·23	—	0·10	0·14	0·13	0·03

## CHAPTER V.

## ANNUAL VARIATION. FOURIER COEFFICIENTS.

§36. To throw more light on the nature of the annual variation in the amplitude of the diurnal inequalities, the ranges, the sum of the 24 hourly differences from the mean, and the amplitude  $c_1$  of the 24-hour wave were analysed in the Fourier series

$$M + P_1 \sin(t + \theta_1) + P_2 \sin(2t + \theta_2) + \dots,$$

where  $t$  represents time counted from January 1st, a month in  $t$  answering to  $30^\circ$ .  $M$  represents, of course, the mean value for the year, while  $P_1, P_2$  are the amplitudes,  $\theta_1, \theta_2$  the phase angles of the 12-month and 6-month waves. Differences in the lengths of the calendar months were neglected. The values of  $P_1, P_2, \theta_1, \theta_2, P_1/M, P_2/M$  and  $P_2/P_1$  for the several elements dealt with are recorded in Table XLIV.

Means of the quantities in the last 5 columns, derived from D (all days), H, V and I are compared with corresponding means derived from the D, H, V and I results (on quiet days during 1890 to 1900) at Kew. As the Antarctic results are based on only two years' observations, they are presumably not so close an approximation to what exactly represents average conditions as are the Kew results. Still, they present features which can hardly be regarded as the result of accident, and which seem of much interest.

We know already that the Antarctic diurnal inequality varies little in type throughout the year, and that the 24-hour Fourier wave is largely dominant. Thus we might have anticipated that no very large differences would exist between the values of  $\theta_1$  or the values of  $P_1/M$  derived from the ranges, the sum of the 24 differences and  $c_1$  in any one element. But we could not have foreseen that the differences would be so small as appears from Table XLIV.

There is also remarkably little difference between the values of  $\theta_1$  or between the values of  $P_1/M$  which are derived from the Horizontal Force, the Vertical Force and the Inclination. There is a somewhat conspicuous difference between the values of  $\theta_1$  and between the values of  $P_1/M$  derived, in the case of the Declination, from all and from quieter days. Also, somewhat curiously, whilst the all-days' value of  $P_1/M$  accords closely with the corresponding values for H, V and I, it is the quieter-days' value of  $\theta_1$  that accords most closely with the corresponding angles for the other elements.

The fact that the quieter-days' Declination value of  $P_1/M$  is enhanced indicates that, relatively considered, the seasonal variation in the amplitude of the diurnal inequality is greater for quieter days than for all days.

In all cases the 6-month wave is smaller than the 12-month wave, but on the average of the elements its relative importance appears greater in the Antarctic than at Kew.

The large difference between the values of  $\theta_1$  at Kew and in the Antarctic arises almost entirely from the six-month difference in the season. If we add  $180^\circ$ , *i.e.* six months, to the Antarctic value of  $\theta_1$  we get to within  $3^\circ$ —or roughly three days—of the Kew value. In the case of the 6-month term the difference between the mean values of  $\theta_2$  for the Antarctic and Kew is  $188^\circ$ , or about three months and four days. This means that this wave also is at Winter Quarters very nearly opposite in phase to what it is at Kew.



## CHAPTER VI.

## ABSOLUTE DAILY RANGES. DAILY MAXIMA AND MINIMA.

§38. By the *absolute range* of an element is meant the excess of the absolutely largest over the absolutely smallest value met with during the 24 hours. The term *absolute* is added to indicate that the quantity considered is not the range of the regular diurnal inequality, nor the range derived from mere hourly readings. The absolute ranges are at once derivable from the daily maxima and minima given in the tables of tabulated values, but for convenience of reference they have been collected and presented in Tables XLVI, XLVII, and XLVIII.

It is of course impossible ever to say with certainty, in the case of an absolutely isolated station like Winter Quarters, what may have been taking place during the time of changing papers. There is always the possibility that, in the course of a few minutes during which no trace was being recorded, an element may suddenly have changed and then reverted to near its primitive value. But even in the Antarctic, though large sudden changes were not of very rare occurrence, it was very unusual for them to occur singly, and one could usually feel fairly confident that neither the daily maximum nor the daily minimum had occurred whilst there was no paper on the drum. When, however, the interval between successive sheets was considerable, as occasionally happened, or when the trace was highly disturbed about the time of changing, there might be considerable doubt as to whether a maximum or minimum might not have occurred in Declination or Horizontal Force.

In Tables XLVI and XLVII, relating respectively to D and H, ranges are usually given whether the record for the day was complete or not. There are, however, omissions on a few days when the traces were confused or indistinctly visible. Figures inside [ ] brackets relate to days when the record was incomplete, but when the general appearance of the curve seemed to warrant the belief that both the maximum and the minimum for the day were actually recorded. Figures inside ( ) brackets are for days of incomplete record, when appearances suggested that either the maximum or the minimum, if not both, was unrecorded. The combination > + means that the trace went beyond the limit of registration in the direction of element increasing, while > - means that the trace exceeded the limit in the direction of element diminishing. When both limits were exceeded, the combination > ± is employed. The sign \* denotes that the trace was too confused to decipher, while — denotes that no trace, or only a few hours' trace, existed. Figures preceded by > are certainly, and those in ( ) brackets probably, under-estimates of the true range.

In the case of D, and still more in that of H, the number of days when the record was incomplete was so considerable, and the cause was so frequently due to the limits of registration being exceeded, especially in Summer, that a very imperfect idea of the average amplitude would have been derived if days of incomplete record had been omitted. This consideration did not, however, apply to V, as loss of record of this element very seldom arose merely from the daily amplitude being large. The almost invariable cause was defective action in the magnetograph, or loss of temperature trace, and so ignorance of the temperature correction. There was thus no reason to regard the ranges derived from days of complete record as below the average size. It was thus decided to give maxima and minima and absolute ranges only for the days of complete record. These ranges appear in Table XLVIII, and means are given for the separate months. In February, October, November, and December, 1903, however, the number of days from which the means are derived are so small that the figures possess but slight significance.

TABLE XLVI.—Absolute Ranges. Declination.

Day.	1902.										1903.											1904.			
	March.	April.	May.	June.	July.	August.	September.	October.	November.	December.	January.	February.	March.	April.	May.	June.	July.	August.	September.	October.	November.	December.	January.		
1	—	(>114·0-)	(43·7)	118·2	94·3	34·2	72·6	(>127·5+)	>193·0+	150·0	156·5	88·5	61·0	100·1	67·5	65·4	>216·0	*	72·5	>143·2+	(198·0)	—	—		
2	(71·6)	76·5	59·3	43·5	(29·2)	20·3	114·5	[> 80·2+]	125·6	>238·8+	175·2	126·5	166·2	110·7	48·7	209·1	123·3	52·2	87·0	>209·4+	>221·4+	—	—		
3	(65·2)	88·2	39·3	39·1	20·2	62·0	102·6	(> 87·4+)	132·5	187·0	177·9	(179·4)	105·0	76·9	56·4	167·4	79·6	46·8	92·4	(124·8)	(>142·5+)	—	—		
4	—	104·8	66·0	16·5	62·3	73·0	109·1	109·5	93·2	195·3	>235·5-	75·9	75·9	75·7	51·3	151·0	50·4	39·7	93·6	—	—	—	—		
5	(15·0)	112·5	45·6	26·7	46·4	33·2	68·7	50·7	58·7	113·3	>235·5-	>294·0±	140·2	141·0	223·5	103·5	44·0	130·3	127·0	—	(>192·0+)	—	—		
6	(97·5)	61·5	39·0	49·8	42·0	21·8	66·3	69·0	61·3	175·5	172·9	(>108·0-)	143·1	>227·0-	>170·1-	39·7	234·6	46·1	238·8	(124·8)	>205·5+	—	—		
7	—	64·5	42·0	64·8	(30·7)	[16·0]	71·3	55·5	>151·8+	102·6	170·7	90·3	>134·3-	121·5	183·5	45·5	85·2	44·1	72·3	>198·0+	(>132·7+)	—	(115·2)		
8	—	82·5	64·5	63·0	(48·8)	(19·5)	29·0	63·8	126·0	225·9	129·4	>124·2-	119·0	110·2	118·0	(32·5)	23·7	51·3	>171·9+	(169·2)	(>247·5+)	—	(>123·0+)		
9	—	137·5	213·0	18·5	78·4	51·0	58·5	88·9	101·1	173·7	169·2	[261·6]	>204·0-	>193·8-	120·9	(32·9)	67·4	*	>233·2+	—	(>126·7+)	—	(>115·5+)		
10	—	72·4	(170·3)	(22·5)	51·5	42·8	63·0	53·3	127·0	>294·0±	>239·2-	150·0	101·4	200·4	84·7	62·7	133·0	*	(163·2)	—	—	—	(>115·5+)		
11	—	(>175·5-)	(44·2)	(37·5)	33·3	111·7	70·3	85·5	[78·6]	199·8	242·7	213·0	93·6	149·3	36·2	49·5	159·3	*	—	—	—	—	—		
12	—	135·8	(21·0)	142·0	156·0	45·9	66·5	>124·5+	[112·9]	157·8	>198·8-	143·4	112·5	103·2	35·0	34·2	84·3	*	—	(197·4)	—	—	(>204·7+)		
13	(81·7)	63·0	(50·3)	46·5	47·0	24·0	105·4	88·5	(119·2)	226·5	112·5	[273·0]	202·0	133·8	(30·8)	50·5	81·7	(113·6)	—	>292·5±	—	—	(81·0)	(>204·7+)	
14	(>73·5+)	108·0	—	37·8	24·6	38·3	31·5	87·0	153·0	151·8	188·6	(>202·5-)	155·0	87·8	—	33·4	74·5	>226·5+	—	—	—	—	—	(>294·0±)	
15	(18·0)	58·5	(11·3)	51·8	28·5	26·4	42·0	93·0	226·2	171·3	120·0	140·5	96·0	129·7	—	(15·7)	104·6	184·5	—	(54·9)	—	—	—	(101·3)	
16	93·8	(27·0)	15·0	68·1	89·6	52·8	56·2	61·2	190·5	181·0	112·9	126·0	92·4	118·8	—	(24·7)	(23·3)	60·4	—	>120·7+	—	—	—	(>283·5-)	(>230·2+)
17	(80·3)	(89·2)	12·8	12·6	25·5	23·7	[75·0]	90·6	146·8	185·2	(108·7)	125·9	48·0	49·5	—	169·9	(72·6)	153·6	—	>145·5+	—	—	—	(>219·0+)	
18	113·3	54·3	65·2	41·7	[21·6]	91·1	67·5	92·3	90·0	88·8	(90·8)	>149·7-	51·4	139·5	(21·0)	(126·8)	109·7	75·1	—	(>142·6+)	—	—	—	—	
19	(62·3)	59·3	41·2	19·2	—	28·8	(>119·2+)	>139·5+	171·0	148·2	(96·0)	119·4	117·0	137·4	37·9	133·5	201·0	50·3	—	—	—	—	—	—	
20	(37·5)	118·3	70·2	36·7	(8·6)	24·8	(173·2)	54·8	90·9	154·3	>237·0-	169·7	>150·0-	60·5	24·0	111·9	162·5	58·5	(112·5)	—	—	—	—	—	—
21	[59·3]	>213·0-	46·5	11·1	24·0	67·8	>131·2+	104·2	165·4	114·0	159·4	[140·1]	115·8	107·2	36·0	54·7	93·6	147·4	>132·7+	—	—	—	—	—	—
22	(55·5)	121·5	51·0	76·6	11·0	>210·7+	50·4	84·0	>250·5+	247·5	160·2	>158·4-	91·5	47·7	(83·2)	178·1	52·5	>291·0±	120·7	—	—	—	—	—	—
23	(29·3)	63·0	[27·1]	56·1	40·5	98·3	143·7	60·0	>223·5+	>295·5±	177·7	93·3	[135·8]	58·5	(30·9)	126·0	37·0	250·8	>208·5+	—	—	—	—	—	—
24	(>115·5-)	76·9	(6·8)	42·4	152·1	108·3	98·1	>162·7+	>294·0±	>233·7+	235·8	113·7	102·6	(29·4)	(27·3)	156·5	56·5	>174·9+	>216·0+	—	—	—	—	—	—
25	(166·5)	27·0	50·3	55·8	>203·0+	80·1	62·2	>147·0+	>252·0+	209·2	(155·4)	137·8	43·2	(36·8)	(71·2)	84·0	45·3	125·4	(97·5)	—	—	—	—	—	—
26	(34·5)	37·5	44·3	72·3	162·8	84·0	83·0	102·6	>195·7+	(172·8)	—	137·9	46·3	44·8	(92·4)	39·1	>240·0-	>289·5±	—	(138·0)	—	—	—	—	—
27	(104·3)	22·5	33·0	74·0	75·6	52·5	59·1	>181·5+	158·3	>252·0+	(>198·0-)	109·2	39·6	(127·5)	(18·7)	17·1	153·9	180·3	—	>198·7+	—	—	—	—	—
28	84·0	49·9	25·8	45·3	19·2	55·5	[84·6]	>180·7+	155·5	>267·0-	(147·0)	65·7	42·7	(47·3)	(75·2)	>161·6-	195·9	110·9	—	(>127·5+)	—	—	—	—	—
29	45·8	(15·7)	39·7	126·0	49·5	57·8	(78·8)	>156·0+	109·5	[105·0]	125·2	—	71·4	47·1	(76·7)	>270·4+	153·2	96·0	(186·0)	—	—	—	—	—	—
30	57·0	(39·0)	92·3	129·0	27·4	53·3	113·4	(>287·1+)	124·5	101·2	>163·0-	—	105·0	65·1	110·0	185·2	(67·9)	127·5	>201·7+	—	—	—	—	—	—
31	(54·7)	—	38·0	—	24·3	124·5	—	>268·5+	—	159·3	82·2	—	182·3	—	60·7	—	*	100·5	—	—	—	—	—	—	—

TABLE XLVII.—Absolute Ranges. Horizontal Force. (Unit 1γ.)

Day.	1902.										1903.												1904.
	March.	April.	May.	June.	July.	August.	September.	October.	November.	December.	January.	February.	March.	April.	May.	June.	July.	August.	September.	October.	November.	December.	January.
1	—	(>211-)	(137)	122	120	39	76	(> 90+)	>107±	140	84	> 97+	40	> 96+	51	96	129	*	51	>100-	(>133-)	—	—
2	(81)	>216±	78	44	57	46	> 90+	[83]	> 65+	>160±	[>118+]	>110+	>109+	> 65+	44	>154±	>122+	> 78-	> 68-	>125-	>140-	—	—
3	—	>216±	55	51	23	70	>108±	(67)	>103+	123	> 55+	(> 74+)	> 93+	> 77+	38	>148±	>115+	47	> 82-	(> 88-)	[>153±]	—	—
4	—	>201-	47	27	134	46	82	>107±	59	103	> 94+	> 65+	77	> 59+	72	>132+	45	32	> 60-	—	—	—	—
5	—	>122-	49	68	67	29	> 83+	> 81+	52	>135-	> 72+	> 87+	>110±	> 73+	> 96+	75	40	>151+	>121-	—	[>153±]	—	—
6	—	>173-	44	40	36	33	84	51	> 59+	>145-	> 85+	>105+	>104-	>144±	>150±	38	>146±	69	>153±	(> 68-)	> 89-	—	—
7	—	>202±	32	44	(17)	[26]	>112-	41	>106±	93	103	> 86+	> 99+	>144±	>103+	54	78	67	95	>118-	(> 23-)	—	(> 90-)
8	—	>196±	53	39	(47)	(22)	34	40	> 56+	140	127	>115±	>110±	>110+	108	(38)	36	81	>155±	[>154±]	(> 94-)	—	(> 80-)
9	—	>207±	176	24	159	26	37	> 56+	75	130	[139]	[>112±]	>106±	>115+	90	(62)	36	*	>154±	—	—	—	(> 96-)
10	—	>198-	(>224-)	(17)	> 93+	25	61	> 61+	> 56+	>161±	>160±	>107+	77	>131+	69	60	93	*	[>150±]	—	—	—	—
11	—	—	(> 29-)	(51)	38	> 75+	77	> 93+	[> 74+]	147	>147-	>116±	>114±	>133+	39	37	>151±	*	—	—	—	—	—
12	—	>153-	(72)	99	104	56	67	>108±	[> 35+]	>159±	>161±	>102+	> 80+	> 63+	29	49	95	*	—	(> 60-)	—	(> 75-)	(>149+)
13	(95)	88	(61)	> 79+†	96	64	>107-	58	(> 95±)	>155±	109	[>101±]	>112±	> 80+	(26)	49	86	*	—	[>157±]	—	>131-	—
14	—	97‡	—	53	23	30	29	> 60+	>126-	>134-	129	[> 91+]	>111±	52	—	46	65	>153±	—	—	—	>160±	—
15	(66)	51‡	(11)	60‡	53	65	30	> 74+	>121-	>153±	134	> 98+	>107±	>138-	—	(18)	112	>152±	—	(> 97-)	—	>116-	(43)
16	[>118+]	(> 50+)	30	96	88	43	61	69	> 99-	123	137	>113±	> 93-	142	—	(42)	(40)	67	—	> 80-	—	(>116-)	[>162±]
17	[>196±]	(88)	47	19	41	51	[> 88+]	67	131	>159±	(116)	> 83+	49	30	—	112	(>136+)	> 96-	—	>105-	—	—	[>151-]
18	[>193±]	55	71	35	44	>153+	79	> 63+	96	101	—	> 90+	32	125	(45)	(>105+)	>150-	> 92-	—	[>155±]	—	—	—
19	[>223+]†	57	51	28‡	(24)	44	(> 92+)	> 98+	>128-	>124+	(> 57-)	67	74	>117+	35	>151±	>148±	> 64-	—	—	—	—	—
20	(>185+)	114	84	40	(21)	41	[>106±]	> 69+	>114-	>150+	>103±	> 64+	84	42	36	125	>100-	71	(>128-)	—	—	—	—
21	(173)	>120-	54	30‡	44	80	> 97+	66	>135-	126	> 92+	[> 61+]	> 71+	69	50	89	>123+	>131-	[>131-]	—	—	—	—
22	(>157+)	111‡	47	118	24	>114±	69	> 83+	>139-	>130+	> 56+	>104+	> 86+	37	[72]	>141+	65	>154±	> 84-	—	—	—	—
23	(90)	94	(21)	58‡	38	> 92+	> 78+	> 69+	>143-	>159±	[> 86+]	73	[>101+]	41	(48)	133	53	>124-	>155±	—	—	—	—
24	—	102	(19)	26	[>126+]	> 91+	> 92+	> 93+	>160±	>159±	>104±	> 85+	> 62+	(77)	(25)	>141+	53	>151±	>152-	—	—	—	—
25	—	41	72	86	>136+	86	34	>110+	>160±	>159+	(53)	>111±	[44]	(91)	(76)	73	46	>127-	(79)	—	—	—	—
26	—	36	66	>100+	>132+	81	> 80+	> 81+	>159±	>133+	—	80	40	58	(43)	23	>151±	>154±	—	(>148-)	—	—	—
27	—	52	82	56	78	52	> 72+	>103+	>107-	>158±	[>113±]	>104+	50	(> 81+)	(18)	14	>120-	>155±	—	>127-	—	—	—
28	(144)	54	48	110	27	44	(67)	>111±	94	>150+	(>108-)	58	61	(> 55+)	(>132+)	102	>151±	>102-	—	[>130-]	—	—	—
29	182	(38)	39	63	40	50	(42)	> 89+	134	(113)‡	> 88+	—	> 71+	76	[>111+]	>140+	126	> 59-	(>152-)	—	—	—	—
30	>162-	(57)	>119+	>160+	32	35	61	>107±	> 99+	(85)	> 54+	—	>109+	63	99	>148±	*	> 85-	>153±	—	—	—	—
31	(> 92-)	—	62	—	24	> 81-	—	>106±	—	>109-	>112±	—	> 86+	—	93	—	*	> 86-	—	—	—	—	—

† Range on March 19, 1902, is probably an over-estimate. Reason to suspect a change in the base line.

‡ Discontinuity allowed for.



TABLE XLVIII.—Absolute Ranges. Vertical Force. (Unit 1γ.)

Day.	1902.										1903.											
	March.	April.	May.	June.	July.	August.	September.	October.	November.	December.	January.	February.	March.	April.	May.	June.	July.	August.	September.	October.	November.	December.
1	—	—	—	93	42	74	67	—	195	134	259	—	—	142	30	59	—	—	33	72	—	—
2	—	—	67	61	27	75	78	—	—	—	—	—	154	89	54	209	70	—	80	—	161	—
3	—	—	112	—	25	88	75	—	—	125	—	—	—	68	58	128	70	—	66	—	—	—
4	—	80	—	74	50	51	—	—	53	95	—	—	—	60	37	123	72	51	82	—	—	—
5	—	145	108	63	42	36	48	—	46	112	—	—	—	126	92	68	49	86	55	—	—	—
6	—	83	53	61	33	—	—	—	45	130	263	—	—	—	183	65	194	31	129	—	164	—
7	—	51	41	79	—	—	44	44	35	71	—	92	232	—	112	67	58	74	43	245	—	—
8	—	115	56	45	—	—	39	31	67	135	141	—	118	127	139	—	28	49	90	—	—	—
9	—	82	168	42	102	69	54	48	61	60	—	—	103	114	49	—	81	66	113	—	—	—
10	—	—	—	—	—	104	52	37	56	233	—	—	99	—	55	52	93	—	—	—	—	—
11	—	—	—	—	34	103	92	—	—	94	394	—	107	—	62	49	74	—	—	—	—	—
12	—	190	—	86	63	174	59	65	—	—	415	—	209	100	46	39	80	—	—	—	—	—
13	—	63	—	62	71	112	—	80	—	—	213	—	128	105	—	24	97	—	—	—	—	122
14	—	81	—	39	—	—	—	59	103	163	225	—	157	—	—	34	46	149	—	—	—	318
15	—	101	—	—	—	94	—	44	187	95	202	—	82	—	—	—	59	227	—	—	—	128
16	162	—	—	95	42	120	—	97	—	—	137	—	133	—	—	—	—	46	—	102	—	—
17	—	—	45	48	46	36	—	—	—	128	—	—	66	—	—	73	—	80	—	123	—	—
18	91	56	28	41	—	51	—	70	—	—	—	—	—	—	—	—	136	50	—	—	—	—
19	88	—	44	—	—	59	—	87	119	—	—	—	—	—	35	64	258	48	—	—	—	—
20	58	—	52	—	—	47	—	53	103	—	—	—	—	—	34	—	149	47	—	—	—	—
21	—	—	30	39	15	—	—	41	110	—	—	—	89	—	46	—	91	136	161	—	—	—
22	—	—	43	53	39	103	—	112	142	134	94	98	63	47	—	97	27	249	78	—	—	—
23	—	—	—	54	42	60	—	32	154	—	—	—	—	63	—	—	77	—	92	—	—	—
24	—	—	—	41	75	76	—	—	303	115	—	—	—	—	—	—	—	—	115	—	—	—
25	152	—	—	68	55	74	—	—	—	121	—	—	—	—	—	—	—	130	—	—	—	—
26	—	50	—	72	165	57	—	49	—	—	—	101	46	84	—	54	—	—	—	—	—	—
27	—	—	—	56	—	59	—	69	—	—	—	—	37	—	—	48	253	—	—	138	—	—
28	59	—	76	44	36	67	—	155	—	—	—	—	25	—	—	190	165	—	—	—	—	—
29	44	—	50	99	28	51	—	87	—	—	—	—	61	—	—	131	111	—	—	—	—	—
30	66	—	—	166	24	40	—	—	—	—	—	—	47	61	68	130	57	—	146	—	—	—
31	—	—	—	—	46	78	—	—	—	—	—	—	106	—	57	—	125	92	—	—	—	—
Means . .	90	91	65	66	50	75	61	66	111	122	234	97	103	91	67	85	101	95	92	(136)	(162)	(189)

§39. Table XLIX gives an analysis of the results obtained by grouping the ranges of Declination according to their amplitude. The first group gives the number of days in which the range did not exceed 30', the second the number of days in which the range, while in excess of 30', did not exceed 1°, and so on, the seventh and last group giving the number of days in which the range exceeded 3°. Days were arranged in two principal classes, the first including all days when the record was complete, or when loss of trace was due solely to one or both limits of registration being exceeded, the second including all days when there was imperfection of record through photographic failure, absence of sheet, or similar cause. Each of these two classes was sub-divided into two sub-classes, according as the trace did or did not keep within the limits of registration. The days are arranged under three seasons, Midwinter (May to July), Midsummer (November to January), Equinox (March, April, September, and October). The results for the remaining months, August, 1902 and 1903, and February, 1903, are combined.

TABLE XLIX.—Declination Ranges.

	Days when no incompleteness or failure of record, except through the trace going beyond the limits of registration.															
	Days when trace kept within limits of registration.								Days when trace went beyond one or both limits of registration.							
	Total of Days.	Range.							Total of Days.	Range.						
		0' to 30'.	30' to 60'.	60' to 90'.	90' to 120'.	120' to 150'.	150' to 180'.	Over 180'.		0' to 30'.	30' to 60'.	60' to 90'.	90' to 120'.	120' to 150'.	150' to 180'.	Over 180'.
Midwinter . . . . .	138	21	53	26	10	8	12	8	6	0	0	0	0	0	2	4
Equinox . . . . .	130	3	29	39	38	15	2	4	27	0	0	0	0	10	3	14
Midsummer . . . . .	62	0	1	4	11	10	21	15	23	0	0	0	0	0	2	21
February and Augusts	67	7	18	10	12	14	2	4	8	0	0	0	0	1	2	5
Total . . . . .	397	31	101	79	71	47	37	31	64	0	0	0	0	11	9	44
	Days when record incomplete from some cause other than trace going beyond limits of registration.															
	Days when trace kept within limits of registration.								Days when trace went beyond one or both limits of registration.							
	Total of Days.	Range.							Total of Days.	Range.						
		0' to 30'.	30' to 60'.	60' to 90'.	90' to 120'.	120' to 150'.	150' to 180'.	Over 180'.		0' to 30'.	30' to 60'.	60' to 90'.	90' to 120'.	120' to 150'.	150' to 180'.	Over 180'.
Midwinter . . . . .	33	14	10	6	1	1	1	0	0	0	0	0	0	0	0	0
Equinox . . . . .	39	6	9	9	4	5	4	2	12	0	0	3	3	3	1	2
Midsummer . . . . .	14	0	0	2	8	1	2	1	12	0	0	0	1	4	0	7
February and Augusts	8	2	1	0	1	1	1	2	2	0	0	0	1	0	0	1
Total . . . . .	94	22	20	17	14	8	8	5	26	0	0	3	5	7	1	10

It will be noticed that out of a total of 111 days in Midsummer there was only one in which the range did not exceed 1°, while at least 44 had a range in excess of 3°. Taking the whole period, we find that out of 461 days for which the record was complete, except for the limits of registration being exceeded, 329, or 71 per cent., had a range over 1°; 250, or 54 per cent., had a range over 1½°; 179, or 39 per cent., a range over 2°, and 75, or 16 per cent., a range over 3°. Of the 581 days, complete and incomplete, included in the table, 407, or 70 per cent., had a range over 1°; 218, or 38 per cent., a range over 2°; 90, or 15½ per cent., a range over 3°; while 24, or fully 4 per cent., had a range over 4°. On seven days the trace exceeded the limits of registration on both sides of the sheet, whose complete width represented from 4° 50' to 4° 55'.

§40. Results for H corresponding to those for D, just discussed, appear in Table L. It contains two principal classes, each with two sub-classes analogous to those in Table XLIX. The ranges are again dealt with in seven groups, the first containing days in which the range did not exceed 25γ, the second days in which the range exceeded 25γ but did not exceed 50γ, and so on, the last group containing days when the range exceeded 150γ. Owing to the sensitiveness of the Horizontal-Force magnetograph, the limits of registration were exceeded in about one day out of two. In Midsummer the limits were exceeded

in eight days out of eleven, so that our information at this season is unfortunately very imperfect. Even during Midwinter the range exceeded 25 $\gamma$  on 90 per cent. of the days.

TABLE L.—Horizontal Force Ranges. (Unit 1 $\gamma$ .)

	Days when no incompleteness or failure of record, except through the trace going beyond the limits of registration.															
	Days when trace kept within limits of registration.								Days when trace went beyond one or both limits of registration.							
	Total of Days.	Range.							Total of Days.	Range.						
0 to 25.		25 to 50.	50 to 75.	75 to 100.	100 to 125.	125 to 150.	Over 150.	0 to 25.		25 to 50.	50 to 75.	75 to 100.	100 to 125.	125 to 150.	Over 150.	
Midwinter . . . . .	116	8	45	29	18	10	4	2	29	0	0	0	3	8	10	8
Equinox . . . . .	59	0	19	21	13	4	1	1	94	0	0	17	25	29	7	16
Midsummer . . . . .	24	0	0	3	4	6	11	0	58	0	0	8	7	12	13	18
February and Augusts	34	1	15	13	5	0	0	0	43	0	0	4	16	13	2	8
Total . . . . .	233	9	79	66	40	20	16	3	224	0	0	29	51	62	32	50
	Days when record incomplete from some cause other than trace going beyond limits of registration.															
	Days when trace kept within limits of registration.								Days when trace went beyond one or both limits of registration.							
	Total of Days.	Range.							Total of Days.	Range.						
Midwinter . . . . .	25	10	8	5	1	0	1	0	7	0	1	0	0	2	3	1
Equinox . . . . .	17	0	3	4	7	1	1	1	29	0	0	5	7	2	4	11
Midsummer . . . . .	6	0	1	1	1	2	1	0	21	1	1	2	7	4	2	4
February and Augusts	2	1	1	0	0	0	0	0	5	0	0	2	1	2	0	0
Total . . . . .	50	11	13	10	9	3	3	1	62	1	2	9	15	10	9	16

Of the 457 days for which the record was complete, except for the trace going beyond the limits of registration, 274, or 60 per cent., had a range over 75 $\gamma$ , and 183, or 40 per cent., a range over 100 $\gamma$ . Of the 569 days, complete or incomplete, included in the table, 340, or 60 per cent., had a range over 75 $\gamma$ , and 225, or 40 per cent., a range over 100 $\gamma$ .

If we compare the D and H results we find that the percentage of days showing a range of over 100 $\gamma$  in H is closely similar to the percentage showing a range of over 2° in D. As 1' in D range answers to about 2 $\gamma$  in H, the natural conclusion—which one would also draw from the diurnal inequalities—is that diurnal variations of force were considerably larger in the direction perpendicular to the magnetic Meridian than in the magnetic Meridian itself. The conclusion is almost certainly correct. At the same time, it should be noticed that even when the H magnetograph was least sensitive it was impossible to record a range much over 200 $\gamma$ , while the possible limit for D was equivalent to nearly 600 $\gamma$  throughout. Thus any deduction based on Tables XLIX and L as to the relative size of the average daily ranges in D and H is practically certain to underestimate the range in H.

§41. Table LI gives some data for V analogous to those in the last two tables. Days are arranged in six groups, the first including cases where the range did not exceed 50 $\gamma$ , the second cases in which it

TABLE LI.—Vertical-Force Ranges. (Unit 1 $\gamma$ .)

	Total of days.	Range.					
		0 to 50.	50 to 100.	100 to 150.	150 to 200.	200 to 250.	Over 250.
Midwinter . . . . .	123	47	53	13	7	1	2
Equinox . . . . .	101	20	49	22	7	3	0
Midsummer . . . . .	47	3	10	18	6	4	6
February and Augusts . . . . .	46	10	24	9	1	2	0
Total . . . . .	317	80	136	62	21	10	8

exceeded 50γ but did not exceed 100γ, the last cases in which it exceeded 250γ. Of the 317 days included, only 5 had a range as small as 25γ, while 101, or 32 per cent., had a range exceeding 100γ. The latter figure is rather smaller than the corresponding percentage in the case of H.

§42. In addition to the results for individual days, Table XLVIII gives means for individual months, varying from 234γ for January, 1903, to 50γ for July, 1902. The monthly means, however, fluctuate somewhat irregularly, and can hardly claim to closely represent average conditions. The January mean, for example, appears abnormally large. This is partly accounted for by the exceptionally large ranges on January 11 and 12. It is by no means impossible that some of the irregularities may be due to errors in the scale values, or in the temperature corrections. The former source of error is most to be feared in the months of July, August, and September, 1902, the latter in the Midsummer months of 1902-3, when the temperature range was especially large.

If we combine corresponding months from the two years, allowing equal weight to each day, we obtain the following somewhat more regular mean monthly values:—

TABLE LII.—Mean Absolute Ranges of V. (Unit 1γ.)

January . . . . . 234	May . . . . . 66	September . . . . . 79	Year . . . . . 91
February . . . . . 97	June . . . . . 74	October . . . . . 81	Midwinter . . . . . 73
March . . . . . 100	July . . . . . 77	November . . . . . 117	Equinox . . . . . 88
April . . . . . 91	August . . . . . 83	December . . . . . 132	Midsummer . . . . . 148

§43. Table LIII gives the largest and smallest absolute ranges recorded in each individual month.

TABLE LIII.—Absolute Ranges.

	Declination.			Horizontal Force. (Unit 1γ.)			Vertical Force. (Unit 1γ.)	
	Largest recorded.	Smallest recorded.		Largest recorded.	Smallest recorded.		Largest recorded.	Smallest recorded.
		On day when record complete.	On any day.		On day when record complete.	On any day.		
1902	° /	° /	° /					
March . . . . .	>2 46·5	45·8	15·0	>196	—	66	162	44
April . . . . .	>3 33·0	22·5	15·7	>216	36	36	190	50
May . . . . .	3 33·0	12·8	6·8	>224	30	11	168	28
June . . . . .	2 22·0	11·1	11·1	>160	19	17	166	39
July . . . . .	>3 23·0	11·0	8·6	159	23	17	165	15
August . . . . .	>3 30·7	20·3	16·0	>153	25	22	174	36
September . . . . .	2 53·2	29·0	29·0	>112	29	29	92	39
October . . . . .	>4 47·1	50·7	50·7	>111	40	40	155	31
November . . . . .	>4 54·0	58·7	58·7	>160	52	>35	303	35
December . . . . .	>4 55·5	1 28·8	1 28·8	>161	93	85	233	60
1903								
January . . . . .	4 2·7	1 22·2	1 22·2	>161	84	53	415	94
February . . . . .	>4 54·0	1 5·7	1 5·7	>115	58	58	101	92
March . . . . .	>3 24·0	39·6	39·6	>114	32	32	232	25
April . . . . .	>3 47·0	47·1	29·4	>144	30	30	142	47
May . . . . .	3 43·5	24·0	18·7	>150	29	18	183	30
June . . . . .	>4 30·4	17·1	15·7	>154	14	14	209	24
July . . . . .	>4 0·0	23·7	23·3	>151	36	36	258	27
August . . . . .	>4 51·0	39·7	39·7	>155	32	32	249	31
September . . . . .	3 58·8	1 12·3	1 12·3	>155	51	51	161	33
October . . . . .	>4 52·5	>2 0·7	54·9	>157	—	>60	245	72
November . . . . .	>4 7·5	>3 25·5	>2 6·7	>153	—	>23	164	161
December . . . . .	>4 54·0	3 39·0	1 21·0	>160	—	>75	318	122
1904								
January . . . . .	>3 50·2	—	1 41·3	>162	—	43		

Even in the case of D there are 16 months in which the largest range of the month is underestimated owing to the limit of registration being exceeded. In the case of H every month, except July, 1902,

suffered in this way. The information as to the smallest ranges does not suffer from any such uncertainty, but subsequent to September, 1903, the number of days of observation was too small to give results of much value. The smallest recorded ranges on days when the record was complete were—

for D, 11'·0 in July, 1902 ;  
 „ H, 14γ „ June, 1903 ;  
 „ V, 15γ „ July, 1902.

Perhaps the most natural way of comparing the different months or seasons of the year as to their relative liability to disturbance is to consider the size of the ratio

(mean absolute range)/(range of diurnal inequality).

This criterion cannot be very readily applied in the present instance, except to the Vertical Force. For it the above ratio has the following values: Midwinter 4·1, Equinox 2·5, Midsummer 2·6. The ratio is thus decidedly largest at Midwinter. The same phenomenon has been observed at Kew in the case of the Declination.

The practical equality of the ratios for Equinox and Midsummer suggests that in the Antarctic the former is not a season of specially large or frequent disturbances. If instead of taking for our criterion of disturbance the ratio of the mean absolute to the inequality range we were to take the amplitude of the mean absolute range, or the frequency of occurrence of specially large ranges, we should come to the conclusion that the equinoctial months were much less disturbed than those at Midsummer. For instance, in the case of D, taking all days, complete and incomplete, the absolute range was in excess of 3° on only 11 per cent. of equinoctial days as against 40 per cent. of Midsummer days.

§44. Tables LIV to LIX show the frequency of occurrence of the daily maxima and minima in D, H and V at different hours of the day. For instance, from Table LIV we see that, taking the 24 days of April, 1902, for which data exist, the maximum in D occurred eight times between 8 and 9 a.m., six times between 9 and 10 a.m., three times in each of the hours 10–11 a.m. and 11 a.m. to noon, and once in each of the hours 5–6 a.m., 7–8 a.m., noon to 1 p.m., and 11–12 p.m. Maxima and minima were assigned for D and H even on days of incomplete record. In some cases the imperfection was of such a nature—*e.g.* trace beyond a limit of registration during part of one hour—as to introduce no uncertainty into the hour of occurrence of either maximum or minimum; in a greater number of cases there was uncertainty as to one only of the two quantities. The number of days in which uncertainty affected the maximum and the minimum often differed widely. Thus in October, 1902, the hour of minimum in H could be assigned on 26 days, but the hour of maximum only on 12. In the case of V, only days of complete record were included, so that maxima and minima were equal in number. The occurrence of  $\frac{1}{2}$  will be noticed in some of the entries for D and H, especially the latter. This may mean equality in the extreme ordinates during two different hours, but it usually signifies that the trace was beyond a limit of registration during part of each of two hours. Days were omitted in which either limit of registration was exceeded during parts of more than two hours.

If irregular disturbances did not exist, the daily maxima and minima would synchronise with the maxima and minima in the diurnal inequalities. But in the highly disturbed conditions of the Antarctic one would not have been entitled to assume *a priori* that the absolute maxima, for instance, would have shown even a preference for the hour of the inequality maximum. Comparing, however, Tables LIV and XIII, we see that the daily maxima for D cluster thickly round the hour 9 a.m., when the maximum presents itself in the mean diurnal inequality for the year. This is true of all the seasons, especially Midsummer. It is truly remarkable that at this season, when disturbances were so large, out of the 79 days for which data exist not one gave an absolute maximum during the 12 hours ending with 2 a.m.

If we define the “concentration” of the frequency as the percentage which the occurrences during the three consecutive hours which, combined, give the greatest number of occurrences bear to the total number, we find in the case of the D maxima for the concentration 41 in Midwinter, 60 in Equinox, and 62 in Midsummer. The time of greatest frequency seems a trifle later in Equinox than in the other two seasons, but the difference is minute.

TABLE LIV.—Declination Maxima. Frequency of Occurrence

Hour ending . . .	A.M.												P.M.												Total.
	1.	2.	3.	4.	5.	6.	7.	8.	9.	10.	11.	Noon.	1.	2.	3.	4.	5.	6.	7.	8.	9.	10.	11.	Midt.	
1902																									
March . . . . .	—	—	—	—	—	1	—	1	1	1	1	—	—	—	—	—	—	—	—	—	—	—	—	—	5
April . . . . .	—	—	—	—	—	1	—	1	8	6	3	3	1	—	—	—	—	—	—	—	—	—	—	1	24
May . . . . .	—	—	—	1	4	1	2	1	3	4	3	1	2	—	—	—	—	—	—	—	—	—	—	—	22
June . . . . .	1	—	2	1	1	—	3	2	4	4	4	3	1	—	1	—	—	—	—	—	—	—	—	1	28
July . . . . .	1	1	—	—	—	3	1	4	4	4	1	1	3	—	2	—	—	—	—	—	—	—	—	—	25
August . . . . .	—	—	2	1	—	1	1	9	2	5	3	1	—	—	1	—	—	—	—	1	—	—	2	—	29
September . . . . .	—	—	—	1	1	—	2	4	10	4	2	1	—	—	—	—	—	—	—	—	—	—	—	1	26
October . . . . .	—	—	—	—	—	1	2	4	4	5	3	1	—	—	—	—	—	—	—	—	—	—	—	—	20
November . . . . .	—	—	1	—	1	—	1	5	8	6	2	—	—	—	—	—	—	—	—	—	—	—	—	—	24
December . . . . .	—	—	—	—	—	1	3	6	9	5	2	—	2	—	—	—	—	—	—	—	—	—	—	—	28
1903																									
January . . . . .	—	—	—	2	—	5	5	3	2	3	2	1	—	1	—	—	—	—	—	—	—	—	—	—	24
February . . . . .	—	1	—	—	—	1	—	2	6	6	2	1	—	1	—	—	—	—	—	—	—	—	—	—	20
March . . . . .	—	—	—	1	—	1	7	6	9	5	—	—	1	—	—	—	—	—	—	—	—	—	—	—	30
April . . . . .	—	—	—	—	—	2	2	1	6	4	5	3	1	1	—	—	—	—	—	—	—	—	—	—	26
May . . . . .	—	1	—	1	—	2	3	2	4	1	1	1	1	—	—	—	—	—	—	—	—	—	—	1	17
June . . . . .	—	1	2	1	—	2	4	3	5	3	1	1	1	—	—	—	—	—	—	—	—	—	—	—	25
July . . . . .	—	—	1	1	3	1	4	4	4	3	3	2	—	—	—	—	—	—	—	—	—	—	—	—	27
August . . . . .	—	—	—	—	—	—	4	4	4	5	2	6	—	—	—	—	—	—	—	—	—	—	—	—	25
September . . . . .	—	—	1	1	—	1	2	1	—	4	—	1	1	—	—	—	—	—	—	—	—	—	—	—	13
October . . . . .	—	—	—	—	—	—	—	1	1	1	—	—	—	—	—	—	—	—	—	—	—	—	1	—	3
November . . . . .	—	—	—	—	—	—	—	—	—	1	—	—	—	—	—	—	—	—	—	—	—	—	—	—	2
December . . . . .	—	—	—	—	—	—	—	1	—	—	—	—	—	—	—	—	—	—	—	—	—	—	—	—	1
All . . . . .	2	4	9	11	10	24	46	65	95	79	40	28	14	3	4	0	1	0	0	1	0	0	3	5	444
Midwinter . . . . .	2	3	5	5	8	9	17	16	24	19	13	9	8	0	3	0	1	0	0	0	0	0	0	2	144
Equinox . . . . .	0	0	1	3	1	7	15	19	39	30	14	9	4	1	0	0	0	0	0	0	0	0	1	3	147
Midsummer . . . . .	0	0	1	2	1	6	9	15	20	14	6	2	2	1	0	0	0	0	0	0	0	0	0	0	79

DECLINATION MAXIMA. OCCURRENCES.

TABLE LV.—Declination Minima. Frequency of Occurrence.

Hour ending . . .	A.M.												P.M.												Total.
	1.	2.	3.	4.	5.	6.	7.	8.	9.	10.	11.	Noon.	1.	2.	3.	4.	5.	6.	7.	8.	9.	10.	11.	Midt.	
1902												2				1			1		1				5
March . . . . .	—	—	—	—	—	—	—	—	—	—	—	—	—	—	—	2	3	6	2	2	1	2	2	1	24
April . . . . .	—	1	—	—	—	—	1	1	—	—	—	—	1	1	—	1	1	3	2	5	1	5	—	2	22
May . . . . .	—	—	—	—	—	—	—	—	—	—	—	—	—	1	—	—	2	3	4	6	4	2	2	2	28
June . . . . .	1	—	—	1	—	—	—	—	—	—	—	—	—	—	—	2	1	4	4	4	6	3	1	—	25
July . . . . .	—	—	—	—	—	—	—	—	—	—	—	—	—	2	—	2	1	1	5	9	2	1	1	1	29
August . . . . .	2	—	1	—	—	—	—	—	1	—	—	—	—	2	—	—	4	6	6	3	1	2	1	—	26
September . . . . .	—	—	—	—	—	—	—	—	—	—	1	—	1	—	2	—	4	6	6	3	1	2	1	—	26
October . . . . .	—	—	—	—	—	—	1	1	—	—	—	—	—	1	—	3	5	5	6	—	3	1	2	—	28
November . . . . .	1	1	—	—	—	1	3	2	—	1	—	—	—	—	—	1	2	4	3	3	2	2	1	—	27
December . . . . .	1	—	1	—	1	2	2	1	2	1	—	1	—	1	2	1	3	5	3	—	—	—	1	—	28
1903																									
January . . . . .	—	1	2	—	—	1	—	4	3	2	1	—	—	—	1	1	2	—	1	1	1	1	—	2	24
February . . . . .	—	—	—	—	—	—	—	1	1	—	—	2	1	—	—	—	1	3	3	1	4	2	—	—	19
March . . . . .	—	—	—	1	—	—	—	2	—	—	—	1	1	—	—	3	2	6	5	5	2	—	1	1	30
April . . . . .	1	1	—	—	—	—	—	—	—	1	—	—	1	—	1	2	2	3	3	6	1	1	1	—	24
May . . . . .	—	—	—	—	—	—	—	—	—	—	1	—	1	2	—	1	—	4	4	2	1	—	1	—	17
June . . . . .	1	1	—	—	—	1	—	—	—	—	—	—	—	—	—	—	1	7	4	4	4	—	—	2	25
July . . . . .	1	—	—	—	—	—	1	1	1	—	—	—	—	—	—	1	—	7	4	6	3	2	—	—	27
August . . . . .	1	1	—	—	—	—	—	—	—	—	—	—	—	—	—	3	3	4	1	7	3	1	1	—	25
September . . . . .	1	—	—	—	—	—	—	—	—	—	—	—	—	—	—	2	1	2	2	1	2	—	2	—	13
October . . . . .	—	—	—	—	—	—	—	—	—	—	—	—	—	—	—	—	—	—	1	3	—	1	—	—	5
November . . . . .	—	1	—	—	—	—	—	—	—	—	—	—	—	—	—	—	—	1	—	—	—	—	—	—	2
December . . . . .	—	1	—	—	—	—	—	—	—	—	1	—	—	—	—	—	—	—	—	—	—	—	—	—	2
All . . . . .	10	8	4	2	1	5	7	13	9	5	3	8	6	8	11	28	41	73	61	68	41	18	16	9	455
Midwinter . . . . .	3	1	0	1	0	1	1	1	1	0	1	1	2	3	3	4	10	27	25	25	20	5	5	4	144
Equinox . . . . .	2	2	0	1	0	0	1	4	1	1	0	4	3	2	4	15	17	29	20	23	9	8	7	2	155
Midsummer . . . . .	2	4	3	0	1	4	5	7	5	4	2	1	0	1	4	4	9	9	7	3	3	1	2	2	83

TABLE LVI.—Horizontal-Force Maxima. Frequency of Occurrence.

Hour ending . . .	A.M.												P.M.											Total.	
	1.	2.	3.	4.	5.	6.	7.	8.	9.	10.	11.	Noon.	1.	2.	3.	4.	5.	6.	7.	8.	9.	10.	11.		Midt.
1902																									
March . . . . .	—	—	—	—	—	—	—	—	—	—	1	—	1	—	—	1	—	—	—	—	—	—	—	—	3
April . . . . .	—	—	—	—	—	—	—	—	—	—	1	2	2	2	2	2	2	2	—	—	—	—	—	—	15
May . . . . .	—	—	—	—	—	—	—	—	—	1	2	—	3	2	6	2	5	1	—	—	—	—	—	—	22
June . . . . .	—	—	—	—	—	—	—	—	—	—	—	—	6	2	5	4	6	2	1	—	—	1	—	—	27
July . . . . .	—	1	$\frac{1}{2}$	—	—	—	—	—	—	—	1	—	1	3	6	3	$3\frac{1}{2}$	1	1	1	1	—	—	—	23
August . . . . .	—	—	—	—	—	—	—	—	—	2	3	3	4	1	4	3	2	2	1	1	1	—	—	—	27
September . . . . .	—	—	—	—	—	—	—	—	—	—	3	—	7	3	5	1	1	1	—	—	—	—	—	—	21
October . . . . .	—	—	—	—	—	—	—	—	—	—	—	2	—	2	3	1	2	1	1	—	—	—	—	—	12
November . . . . .	—	—	—	—	—	—	—	1	1	—	—	1	2	3	5	4	2	—	1	1	—	—	—	—	21
December . . . . .	—	—	—	—	—	—	—	—	2	—	1	—	2	6	3	2	4	—	—	2	—	—	—	—	23
1903																									
January . . . . .	—	—	—	—	—	—	—	—	—	—	1	1	—	1	1	2	1	1	2	—	—	—	—	—	10
February . . . . .	—	—	—	—	—	—	—	—	—	—	—	—	2	$2\frac{1}{2}$	1	$2\frac{1}{2}$	$1\frac{1}{2}$	$2\frac{1}{2}$	—	—	—	—	—	—	12
March . . . . .	—	—	—	—	—	—	—	—	—	—	1	3	$2\frac{1}{2}$	$5\frac{1}{2}$	2	1	1	1	1	—	—	—	—	—	18
April . . . . .	—	—	—	—	—	—	—	—	—	2	1	1	2	$4\frac{1}{2}$	$4\frac{1}{2}$	$\frac{1}{2}$	$\frac{1}{2}$	1	—	—	—	—	—	—	17
May . . . . .	—	—	—	—	—	—	—	—	—	1	—	—	3	3	—	3	3	$1\frac{1}{2}$	$\frac{1}{2}$	—	—	—	—	—	15
June . . . . .	—	—	—	—	—	$\frac{1}{2}$	—	—	—	$\frac{1}{2}$	1	3	3	3	$1\frac{1}{2}$	$2\frac{1}{2}$	$2\frac{1}{2}$	$1\frac{1}{2}$	—	—	1	—	—	—	20
July . . . . .	—	—	—	—	—	—	—	—	—	1	1	1	3	1	5	$3\frac{1}{2}$	$5\frac{1}{2}$	$1\frac{1}{2}$	$1\frac{1}{2}$	2	—	—	—	—	26
August . . . . .	—	—	—	—	—	—	—	—	—	2	—	2	2	1	4	6	2	2	1	—	—	—	—	—	22
September . . . . .	—	—	—	—	—	—	—	—	—	—	$\frac{1}{2}$	—	2	2	2	$4\frac{1}{2}$	1	—	—	—	—	—	—	—	12
October . . . . .	—	—	—	—	—	—	—	—	—	—	—	1	—	2	—	—	2	1	—	—	—	—	—	—	6
November . . . . .	—	—	—	—	—	—	—	1	—	—	—	—	—	—	—	—	—	—	—	—	—	—	—	—	1
December . . . . .	—	—	—	—	—	—	—	—	—	—	—	—	—	—	—	2	—	—	—	—	—	—	—	—	2
All . . . . .	0	1	$\frac{1}{2}$	0	0	$\frac{1}{2}$	2	3	0	$10\frac{1}{2}$	$16\frac{1}{2}$	21	$47\frac{1}{2}$	$49\frac{1}{2}$	60	$50\frac{1}{2}$	$47\frac{1}{2}$	23	11	7	3	1	0	0	355
Midwinter . . . . .	0	1	$\frac{1}{2}$	0	0	$\frac{1}{2}$	0	0	0	$3\frac{1}{2}$	5	4	19	14	$23\frac{1}{2}$	18	$25\frac{1}{2}$	$8\frac{1}{2}$	4	3	2	1	0	0	133
Equinox . . . . .	0	0	0	0	0	0	0	0	0	2	$7\frac{1}{2}$	9	$16\frac{1}{2}$	21	$18\frac{1}{2}$	11	$9\frac{1}{2}$	7	2	0	0	0	0	0	104
Midsummer . . . . .	0	0	0	0	0	0	2	3	0	1	1	3	4	10	9	10	7	1	3	3	0	0	0	0	57

HORIZONTAL FORCE MAXIMA. OCCURRENCES.





TABLE LVIII.—Vertical-Force Maxima. Frequency of Occurrence.

Hour ending . . .	A.M.												P.M.											Total.	
	1	2	3	4	5	6	7	8	9	10	11	Noon.	1	2	3	4	5	6	7	8	9	10	11		Midt.
1902																									
March . . . . .	3	1	—	1	—	—	1	1	—	—	—	—	—	—	1	—	—	—	—	—	—	—	—	—	8
April . . . . .	5	2	—	—	—	—	—	—	—	—	—	—	—	—	—	—	—	—	—	1	1	1	2	1	12
May . . . . .	3	1	1	1	—	—	—	—	—	—	—	—	—	1	1	—	—	1	1	—	1	1	2	1	15
June . . . . .	5	2	2	—	1	—	—	—	—	—	1	—	—	1	—	—	1	—	—	3	2	3	1	2	24
July . . . . .	2	2	3	2	—	—	—	—	1	—	—	—	—	—	—	1	1	2	2	1	1	2	—	2	22
August . . . . .	5	1	—	—	—	1	—	—	1	—	—	—	—	—	—	1	1	3	2	—	3	4	4	26	
September . . . . .	1	2	1	1	—	—	—	—	—	—	—	1	—	—	—	—	—	—	—	1	1	1	—	1	10
October . . . . .	2	1	1	—	—	1	—	2	—	1	—	—	—	—	—	—	—	—	—	1	—	1	2	7	19
November . . . . .	1	1	—	1	—	2	—	—	—	—	—	—	—	—	—	—	1	—	—	1	1	2	1	5	16
December . . . . .	2	—	2	—	3	—	—	—	1	—	1	—	—	—	—	1	—	—	—	—	1	2	2	1	16
1903																									
January . . . . .	—	1	1	1	1	1	—	1	2	—	—	1	—	—	—	—	—	—	—	—	—	—	—	1	10
February . . . . .	1	1	—	—	1	—	—	—	—	—	—	—	—	—	—	—	—	—	—	—	—	—	—	—	3
March . . . . .	7	3	1	—	1	—	—	—	2	—	—	—	—	—	—	—	—	—	—	—	1	1	—	4	20
April . . . . .	3½	½	2	1	1	—	—	—	—	—	—	—	—	—	—	—	—	—	1	1	1	1	—	1	13
May . . . . .	5	1	1	—	—	1	1	1	—	2	1	—	—	—	—	—	—	—	1	1	—	1	—	1	17
June . . . . .	1	3	2	1	—	—	—	—	1	—	—	—	—	—	—	1	1	2	3	—	1	2	—	2	20
July . . . . .	5	1	—	3	1	—	—	—	—	—	—	—	—	—	1	1	—	2	1	2	—	3	2	3	25
August . . . . .	2	3	5	2	—	—	—	—	—	—	—	—	—	—	—	—	2	—	—	1	1	—	—	1	17
September . . . . .	5	1	—	—	1	—	1	1	—	1	—	—	—	—	—	—	—	—	2	—	—	1	—	1	14
October . . . . .	—	—	1	—	—	1	1	—	—	—	—	—	—	—	—	—	—	—	—	1	—	—	—	1	5
November . . . . .	½	½	—	—	—	—	—	—	1	—	—	—	—	—	—	—	—	—	—	—	—	—	—	—	2
December . . . . .	—	1	—	—	—	—	—	—	—	—	—	—	—	—	—	—	—	—	—	—	—	1	—	1	3
All . . . . .	59	29	23	14	10	7	4	6	9	4	3	2	0	3	3	3	8	8	15	13	15	25	16	38	317
Midwinter . . . . .	21	10	9	7	2	1	1	1	2	2	2	0	0	3	2	2	5	6	9	5	8	11	6	8	123
Equinox . . . . .	26½	10½	6	3	3	2	3	4	2	2	0	1	0	0	1	0	0	0	3	4	4	6	3	17	101
Midsummer . . . . .	3½	3½	3	2	4	3	0	1	4	0	1	1	0	0	0	1	0	1	0	1	2	5	3	8	47

VERTICAL FORCE MAXIMA. OCCURRENCES.

TABLE LIX.—Vertical-Force Minima. Frequency of Occurrence.

Hour ending . . .	A.M.												P.M.												Total.
	1.	2.	3.	4.	5.	6.	7.	8.	9.	10.	11.	Noon.	1.	2.	3.	4.	5.	6.	7.	8.	9.	10.	11.	Midt.	
1902																									
March . . . . .	—	—	—	—	—	—	—	—	—	—	1	1	2	1	2	1	—	—	—	—	—	—	—	—	8
April . . . . .	—	—	—	—	—	—	—	—	—	1	4	2	3	2	—	—	—	—	—	—	—	—	—	—	12
May . . . . .	—	—	—	—	1	—	1	—	2	1	2	1	—	2	—	1	3	—	1	—	—	—	—	—	15
June . . . . .	—	—	—	—	1	—	2	2	4	5	1	1	1	—	1	1	2	—	—	—	1	1	—	—	24
July . . . . .	—	—	—	—	—	3	—	3	2	2	2	2	2	2	1	—	—	—	—	—	—	2	1	—	22
August . . . . .	1	—	1	—	—	1	—	1	2	4	3	4	2	1	1	—	—	—	—	—	—	—	—	—	26
September . . . . .	—	—	—	—	—	—	—	1	—	1	3	2	2	—	1	—	—	—	—	—	—	—	—	—	10
October . . . . .	—	—	—	—	—	1	—	—	2	4	4	1	3	3	—	1	—	—	—	—	—	—	—	—	19
November . . . . .	—	—	—	—	—	—	1	1	2	3	2	2	2	2	1	—	—	—	—	—	—	—	—	—	16
December . . . . .	—	—	—	—	—	1	—	2	2	4	3	—	2	1	—	—	—	—	—	—	—	—	—	—	16
1903																									
January . . . . .	—	1	—	—	—	—	—	—	—	2	—	2	2	2	—	—	—	—	—	—	—	—	—	—	10
February . . . . .	—	—	—	—	—	—	—	—	—	—	½	—	1	1	—	—	½	—	—	—	—	—	—	—	3
March . . . . .	—	—	—	—	—	—	—	—	—	—	1	3	1	2	3	2	3	4	—	—	—	—	—	—	20
April . . . . .	—	—	—	—	—	—	—	1	—	3	2	3	1	1	1	—	1	—	—	—	—	—	—	—	13
May . . . . .	—	—	—	—	—	—	—	—	1	1	2	—	6	—	2	—	1	—	—	—	—	—	—	—	17
June . . . . .	—	1	—	—	—	1	—	1	1	3	2	—	—	1	4	2	2	—	—	—	—	—	—	—	20
July . . . . .	—	—	—	2	1	—	—	1	5	1	3	3	2	1	3	1	1	—	—	—	—	—	—	—	25
August . . . . .	—	—	—	—	—	—	2	—	2	1	2	2	3	—	5	—	—	—	—	—	—	—	—	—	17
September . . . . .	—	—	—	—	—	—	—	1	—	2	4	1	2	2	2	—	—	—	—	—	—	—	—	—	14
October . . . . .	1	—	—	—	—	—	—	1	—	—	—	—	—	1	1	1	—	—	—	—	—	—	—	—	5
November . . . . .	—	—	—	—	—	1	—	—	—	1	—	—	—	—	—	—	—	—	—	—	—	—	—	—	2
December . . . . .	—	—	—	—	—	—	—	—	—	—	1	1	—	—	—	1	—	—	—	—	—	—	—	—	3
All . . . . .	2	2	1	2	3	8	7	14	25	39	42½	31	38	25	28	10	13½	4	1	0	3	4	3	11	317
Midwinter . . . . .	0	1	0	2	3	4	3	7	15	13	12	7	11	6	11	5	9	0	1	0	3	4	1	5	123
Equinox . . . . .	1	0	0	0	0	1	1	3	2	11	19	13	15	12	10	4	4	4	0	0	0	0	0	1	101
Midsummer . . . . .	0	1	0	0	0	2	1	3	4	10	6	5	6	5	1	1	0	0	0	0	0	0	1	1	47

The law of occurrence of minima in D is not so simple. At all seasons, it is true, the greatest frequency of occurrence is from 5 to 7 p.m., the minimum in the diurnal inequality occurring at 6 or 7 p.m.; but there is, at least at Midsummer, a second maximum of frequency. This occurs, curiously enough, about 8 a.m., and so near the hour of the inequality maximum. The cause is probably the marked tendency observed at times for Declination disturbances to be particularly large and numerous from 5 to 10 a.m. The figures for the "concentration" in the frequency, viz. Midwinter 54, Equinox 46, and Midsummer 30, show a marked seasonal contrast to those for the D maxima.

Comparing Tables LVI and XVII, we see that the H maxima mainly occur in the early afternoon, near the hour of the inequality maximum. The figures for the "concentration," viz. Midwinter 50, Equinox 54, Midsummer 51, indicate but little difference between the seasons. The time of greatest frequency of occurrence appears to be somewhat later at Midwinter than at the other seasons; this is in accordance with what is seen in the case of the diurnal inequality.

In the case of the H minima there is a distinct indication, at least in Equinox, of a double maximum in the frequency of occurrence. The greatest concentration is found near the hour—4 or 5 a.m.—of the minimum in the diurnal inequality, but there is also a marked concentration near midnight. Taking the three consecutive hours of greatest frequency as before, the figures for the concentration are: Midwinter 28, Equinox 35, Midsummer 50.

The figures in Tables LVIII and LIX for the maxima and minima in V are a little more irregular than those for D and H. The sensitiveness of the V instrument was so small that the trace, when quiet, appeared to the eye practically a straight line; also the difference between the temperature corrections to be applied at two hours was often in excess of the difference between the uncorrected values. Frequently five or six ordinates had to be measured, and the final differences obtained were not infrequently microscopic. Thus the results are less certain than for the other elements. There is clearly, however, at all seasons a tendency for the maximum to be most frequent near midnight, and the minimum near noon, *i.e.* near the hours of the inequality maximum and minimum. The figures for the "concentration" are—

	Midwinter.	Equinox.	Midsummer.
V maximum . . . . .	33	53	34
V minimum . . . . .	33	47	45

§45. A general idea of the incidence of maxima and minima will be most readily derived from Table LX, which gives the mean results from all the observations. To obtain greater smoothness, the day has been divided into two-hour periods, commencing with midnight. The figures are percentages of the total number of maxima or minima. The maxima of frequency are indicated by heavy type.

TABLE LX.—Percentage Frequency of Occurrence from all Observations.

Two hours ending . . . .		2.	4.	6.	8.	10.	Noon.	2.	4.	6.	8.	10.	Midt.
Declination . . . . .	Maxima . . . . .	1·4	4·5	7·6	25·0	<b>39·2</b>	15·3	3·8	0·9	0·2	0·2	0·0	1·8
	Minima . . . . .	4·0	1·3	1·3	4·4	3·1	2·4	3·1	8·6	25·1	<b>28·4</b>	13·0	5·5
Horizontal Force. {	Maxima . . . . .	0·3	0·1	0·1	1·4	3·0	10·6	27·4	<b>30·3</b>	20·7	5·1	1·1	0·0
	Minima . . . . .	12·2	14·8	21·2	16·4	3·9	0·3	0·8	0·3	0·3	2·1	10·7	16·9
Vertical Force. {	Maxima . . . . .	<b>27·7</b>	11·7	5·4	3·2	4·1	1·6	0·9	1·9	5·0	8·8	12·6	17·0
	Minima . . . . .	1·3	0·9	3·5	6·6	20·2	<b>23·2</b>	19·8	12·0	5·5	0·3	2·2	4·4

## CHAPTER VII.

## TERM-HOUR AND SPECIAL RECORDS.

§46. The scheme of international co-operation in magnetic work included observations to be made on certain "term days," two a month, and especially during certain term hours, one on each term day.

The results of the hourly readings taken during the term days—the 1st and 15th of each month—have already appeared in "Physical Observations," pp. 160–179. The term days all started at Greenwich midnight. On the first of the regular term days, February 1, 1902, the term hour was 0–1 a.m., G.M.T. On the second term day, February 15, 1902, it was 1–2 a.m., G.M.T., and so on, advancing an hour each time for the 24 term days, up to and including January 15, 1903. The scheme included two additional term days, February 1 and 15, 1903, the term hours on which were respectively 0–1 a.m. and 1–2 a.m., G.M.T.

On the term hours it was intended that the magnetograph drums should be rotated at a higher speed than usual, so as to obtain a very open time scale.

To change the speed of rotation entailed the attendance of an observer during the term hour, and as many of the term hours—including in Europe those on the earlier term days—fell during the night, it is, perhaps, not surprising that the number of observatories which took quick runs during all the term hours was very limited. Of the results from the quick-run magnetographs those obtained at Batavia and Pola have already appeared in the official publications of those observatories, where they can be consulted. At Christchurch Observatory quick-run records were obtained throughout the whole 24 hours of the term day and copies of the curves, together with tabulated results at 20-second or 1-minute intervals, were sent home by Dr. C. COLERIDGE FARR and Mr. H. SKEY, the successive Directors of the Observatory. The labour this entailed must have been very great. At Mauritius quick runs were obtained during 10 term hours, and tracings of these and of the slow-run curves obtained during the other term hours were received from the Director, Mr. C. T. F. CLAXTON.

Quick-run curves were obtained at the National Physical Laboratory on all the term hours. Most of these were taken in the Observatory Department, Kew, but some were taken at Teddington, in the Physics Department.

As it so happened, the term hours were one and all exceedingly free from disturbances. When a magnetic disturbance of moderate size occurs, a quick-run curve has great advantages, as it admits of much higher precision in the measurements of time. But when magnetic conditions are very quiet, there is a great compensating disadvantage in that the gradient on the quick-run curve becomes so slight that there are no salient features left to catch the eye. There still may remain substantial advantages for tabulating purposes, but, so far as appeals to the eye are concerned, the quick-run curve becomes really inferior to the slow-run.

Even in 1902 the Kew curves, especially the Vertical-Force ones, were sensibly affected by electric-tram currents. These keep the Vertical-Force magnet in constant oscillation, and though the amplitude is not large it is sufficient to hide from the eye any natural change that is both small and slow. Even at Teddington some of the quick-run curves showed artificial disturbances.

Taking into account the total absence of any but the most insignificant of natural movements—other than the regular diurnal change—it was decided not to reproduce the curves obtained at Kew and Teddington.

An examination of the Mauritius curves showed that, as is usual at most places, the Declination and Vertical-Force curves exhibited less trace of disturbance than the Horizontal-Force curves. As all the curves were very quiet, it appeared unnecessary to go to the expense of reproducing them for all three elements, and the Horizontal Force was selected as the element most worthy of reproduction. The Horizontal-Force curves for all the term hours available appear in Plates I and II.

The copies of the Mauritius curves sent by Mr. CLAXTON were traced by Mr. BROOKES with the curve-tracer designed by Dr. AD. SCHMIDT, and the results from the different term hours were arranged so as to appear in juxtaposition.

§47. In Plate I the successive curves appear one below the other so as to have a common time scale; the vertical cross lines answer to 10, 20 . . . 60 minutes from the commencement of the term hour. The date and the term hour—*e.g.* 6-7 a.m. on May 1, 1902—appear on the left-hand margin. This also shows the absolute value of the Horizontal Force at the commencement of the term hour, as given by Mr. CLAXTON'S own measurements (*cf.* the table on p. 174 of "Physical Observations"). The scale value (1 mm. =  $2.93\gamma$ , or  $20\gamma = 7$  mm. approx.) is also shown at the side. Motion down the sheet means increase of force, as is indicated by the arrows.

On May 1 and June 1 the trace was lacking for a few minutes at the commencement of the hour.

At Mauritius the drums, when quick run, were rotated at twelve times the usual rate. Normally the time scale is about  $15\frac{1}{2}$  mm. to an hour, and so in the quick-run curves it is about 186 mm. to the hour. Plate I shows the curves natural size.

To the eye the departure of the curves from straight lines is not very conspicuous. It is, in fact, so small that it was deemed inexpedient to draw horizontal lines across the sheet to show the absolute values. If anyone wishes to measure variations in the ordinate he may employ as base line the time line at the top. The absolute value of this for the curve of any one hour can be readily arrived at by reference to the absolute value assigned to the commencement of the hour in question.

Plate II gives the slow-run Mauritius Horizontal-Force curves for the remaining term hours for which records were available. To show the trend of the curve, the record extends for about 20 minutes on either side of the term hour, except on October 1, when the original record stopped immediately after the end of the hour. On April 15, 1902, and February 15, 1903, there were small gaps in the original, representing probably the interval required to change the photographic paper on the drum. The curves in Plate II are all very quiet, but owing to the small time scale they appear less quiet to the eye than the quick-run curves in Plate I. On February 1, 1902, there was quite an appreciable amount of variation, but this unfortunately was prior to the arrival of the "Discovery" at Winter Quarters. The curves of October 15, 1902, and January 1, 1903, show some small oscillations.

The original curves had, of course, separate base lines having different absolute values. To economise space, the curves have been so placed in Plate II that a common base line serves for all in one horizontal row. There are thus only three base lines shown, the top one serving for the term hours of the four days February 1 and 15, and March 1 and 15, 1902. In addition to the base line for each group of curves there is a second straight horizontal line, answering to a value of the force exceeding that for the base line by  $50\gamma$ . As in the case of the quick runs, the curves are as nearly as possible exact copies of the original, 1 mm. of ordinate representing  $2.93\gamma$ . As indicating the truly remarkable absence of disturbance, it may be remarked that there is not one of the curves reproduced which shows a range exceeding  $6\gamma$  during the term hour.

§48. At Christchurch, as already stated, quick-run traces were available not merely for the term hours, but for the term days. It was decided, however, for reasons subsequently stated (App. A), to reproduce only two specimens of the term-hour records, and to deal with the Christchurch tabulations in a special Appendix.

The curves selected for reproduction were those taken during the term hours of June 15 and July 1, 1902. Their selection was due to the fact that on these days there were corresponding quick-run curves from the Antarctic.

The Christchurch curves for the term hours of June 15 and July 1 appear in Plate III. To economise space, a single time or base line is drawn to serve for the three elements from each hour. The Declination, Horizontal-Force, and Vertical-Force traces are distinguished by the letters D, H, and V respectively. The absolute value of each element at the commencement of the hour and the corresponding scale value are shown at the left margin. The arrows assist in indicating the direction in which the elements increase (at Christchurch, down the sheet answers in all the elements to an increase). The curves in the photographic copies sent from Christchurch were copied by Mr. BROOKES with the Schmidt tracer. The

scale of ordinates is as in the originals, 1 mm. representing  $1' \cdot 125$  in Declination,  $4 \cdot 53\gamma$  in Horizontal Force, and  $3 \cdot 18\gamma$  in Vertical Force. The slow-run Christchurch time scale is practically the same as at Mauritius and Kew, but the quick-run scale was more open. This was reduced by the tracer so as to be approximately the same as in the Mauritius curves.

On July 1, trace was lacking for about a minute near the beginning of the term hour.

Of the curves themselves it is perhaps sufficient to say that it requires a very acute eye to detect their difference from straight lines.

§49. In the Antarctic, quick-run curves were obtained for the whole of the term hour on June 15, 1902 (9–10 a.m., G.M.T.), for the greater part of the term hour on July 1, 1902 (10–11 a.m., G.M.T.), and for a short portion of the term hour on July 15, 1902.

Plate IV shows the records obtained on June 15. They were copied from the originals by Mr. BROOKES with the Schmidt curve tracer, leaving the scale of ordinates unaltered, but reducing the time scale by about 25 per cent., so as to make it approximately the same as in Plates II and III.  $D_0D_0$ ,  $H_0H_0$ ,  $V_0V_0$  are the base lines for the Declination curve DD, the Horizontal-Force curve HH, and the temperature curve TT respectively. The Vertical-Force magnet was out of action during the hour in question. Vertical lines are drawn answering to 10-minute intervals, the times from the commencement of the hour being marked on the Declination base line. The absolute values answering to the base lines and the scales for the Declination and Horizontal-Force curves are shown on both margins. Fine horizontal lines are drawn to aid the eye in estimating the extent of the movements, and arrows assist in indicating the direction in which the elements increase.

The alteration in the elements is sufficient to make the open time scale of real value. At the same time it should be noticed that the Horizontal-Force magnet was unusually sensitive, so that 1 mm. of ordinate answers to only  $1 \cdot 4\gamma$ . In the case of the Declination the scale is less open, 1 mm. answering to  $1' \cdot 5$ —in force about  $2 \cdot 9\gamma$ —and the change during the hour in Declination is considerably more important than that in Horizontal Force.

Plate V shows the records obtained in the Antarctic during the term hour of July 1. They were treated in the same way as those for June 15. In this case there is a record VV from the Vertical-Force magnet.

There are two gaps in the curves. The first, occurring from about 3 to  $4\frac{1}{2}$  minutes after the commencement of the hour, was due to the light being intercepted by the clamp attaching the paper to the drum. The second, occurring from 26 to 30 minutes after the commencement of the hour, represents the interval occupied in changing papers. The Declination and Horizontal-Force scales have the same value as for June 15. The changes in these elements are somewhat larger than on the previous term day. The departure of the V trace from a straight line is not apparent to the eye. The changes in this element were really less than for the other two, but the difference is exaggerated owing to the fact that the Horizontal-Force scale is almost ten times as open as that of the Vertical Force, for which 1 mm.  $\equiv 13 \cdot 5\gamma$ .

§50. Plates VI to X show the Antarctic records during the remainder of the term hours. April 1 was the earliest term day for which a satisfactory record was obtained. The curves appear in chronological order, omitting, of course, the two days already considered, and likewise the two May term-day hours for which no record existed. The date is shown at the foot, and marks answering to the beginning and end of the term hour appear on all the base lines. The hours (G.M.T.) are recorded on one only of the base lines. As before, the base lines are distinguished by the suffix 0, and the letters D, H, V, and T indicate Declination, Horizontal Force, Vertical Force, and temperature. The absolute values answering to the base lines and the scale values are shown on the left margin, and arrows assist in indicating the directions in which the elements increase (Vertical Force up the sheet, Declination and Horizontal Force down the sheet). To show better the general trend of the curve, the portions of curve reproduced represent in most cases about two hours, including half-an-hour before and half-an-hour after the true term hour. There are, however, exceptions to this on January 15, 1903, when the original record stopped before the end of the term hour, and on July 15, 1902. On the last-mentioned date the trace is restricted to the exact term hour—11 a.m. to noon, G.M.T. It consists of three portions. Starting at 11 a.m., we have a quick run covering about  $1\frac{1}{2}$  minutes, then a gap corresponding to a minute, due to the clamp intercepting the light,

then another quick-run portion covering about  $5\frac{1}{2}$  minutes, then a gap representing the time occupied in changing papers, and, finally, a slow-run portion answering to the period 11.18 a.m. to noon. It is interesting to compare the quick- and slow-run portions of the D and H curves. At first sight one would hardly realise that the curves were really as quiet towards the end of the hour as at the beginning.

In all the curves the Declination has the same scale value, 1 mm.  $\equiv$   $1' \cdot 5$ . In the other elements there is considerable variation. In H the value of 1 mm. varies from  $1 \cdot 4\gamma$  to  $0 \cdot 67\gamma$ , in V it varies from  $16 \cdot 5\gamma$  to  $3 \cdot 2\gamma$ . Full particulars will be found in Table I, or can be derived from the plates themselves. The curves in Plates VI to X were obtained as follows:—

The original Antarctic curves were photographed at Kew by Mr. W. J. BOXALL, light being transmitted through the sheet on to photographic paper immediately in contact with it. From the negatives thus formed positives were made, and when unduly faint these were intensified with pen and ink. In some cases the base lines shown represent exactly the originals, but in other cases the original base lines were replaced by others occurring in greater juxtaposition to the curves to which they really belonged. This was done to minimise the risk of confusion between the different elements.

The latter part of the work was done by Mr. BROOKES at Teddington, under the general supervision of Mr. F. J. SELBY. Every care was taken to avoid introducing departures from the original curves.

In some cases, *e.g.* November 1 and 15, and December 15, 1902, there is, unfortunately, a good deal of intercrossing of the D and H curves. It is hoped, however, that by the aid of the letters attached it will be found possible to distinguish the traces.

The original V trace was lacking on October 1 and November 15, 1902, and on February 1, 1903, while the H trace was off the sheet during the term hours of January 1 and February 15, 1903.

The curves, being exact copies of the originals, are, of course, uncorrected for temperature, and, as will be seen from the TT curves, when these exist, temperature was far from constant. As already explained, the Vertical-Force magnet had a large temperature coefficient; thus a very appreciable temperature correction would in reality be necessary to bring the values of V derived from measurements of the V curves in some of the hours to a common basis. In other words, the base-line value in V was not really constant, and the values actually assigned it refer to only one instant of the hour.

The temperature variations seldom, however, showed rapid oscillations, and whilst the temperature change is, in some cases, responsible for a slight general drift up or down the sheet in the V curve, it is practically without effect on the range of the oscillations shown in the curves.

§51. Owing to the difference in the type of the Antarctic magnetographs from those in use at Christchurch or Mauritius, the difficulty of identifying corresponding movements is materially increased. The difficulty is further enhanced by the fact that we have, in the case of the Antarctic, high sensitiveness in the instruments going along with large disturbance. But whatever the cause may be, I have not succeeded in tracing any close parallelism between individual Antarctic term-hour movements and those at either Mauritius or Christchurch. There is, however, a certain amount of parallelism between the Antarctic and Christchurch curves, as may be seen on reference to Table LXI, which gives the ranges of Declination and of Horizontal Force at the two stations during all the term hours for which information existed. The Christchurch ranges are derived from tabulations, at 20-second intervals, made at Christchurch. The parallelism referred to consists in this, that on the term hours for which the range in the Antarctic is exceptionally low the range was also especially small at Christchurch. The cause, however, so far as Christchurch is concerned, has little to do with disturbance. The hours for which there were specially low ranges in the Antarctic occurred in Midwinter near midnight, and as midnight in the Antarctic and midnight at Christchurch differed by only about 23 minutes, the hours in question were naturally those for which the regular diurnal changes at Christchurch were least.



TABLE LXI.—Term-Hour Ranges.

Day.	Hour, G.M.T.	Range during term hour.			
		Antarctic.		Christchurch.	
		D.	H.	D.	H.
1902			7		7
April 1 . . . . .	4-5	13·5	66·1	1·5	5
" 15 . . . . .	5-6	14·4	14·3	0·3	5
June 1 . . . . .	8-9	51·0	39·2	1·1	7
" 15 . . . . .	9-10	9·3	7·3	0·3	2
July 1 . . . . .	10-11	16·2	14·0	0·2	2
" 15 . . . . .	11-12	11·1	5·6	0·1	3
August 1 . . . . .	12-13	8·4	2·8	0·0	1
" 15 . . . . .	13-14	6·6	7·0	0·4	1
September 1 . . . . .	14-15	5·7	3·4	0·3	0
" 15 . . . . .	15-16	3·9	3·8	0·3	1
October 1 . . . . .	16-17	16·5	19·4	0·4	4
" 15 . . . . .	17-18	18·9	20·8	0·5	1
November 1 . . . . .	18-19	66·8	32·2	1·6	1
" 15 . . . . .	19-20	126·0	99·8+	—	4
December 1 . . . . .	20-21	57·6	67·2+	0·3	8
" 15 . . . . .	21-22	78·6	36·5	1·9	7
1903					
January 1 . . . . .	22-23	43·5	—	3·6	10
" 15 . . . . .	23-24	45·0	25·0	2·0	7
February 1 . . . . .	0-1	39·3	30·4	2·7	2
" 15 . . . . .	1-2	30·0	—	2·2	3
Means . . . . .		33·1	27·5+	1·04	3·7

The means at the foot of Table LXI are derived from all the term hours. Omitting the Declination for November 15, and the Horizontal Force for November 15, December 1, January 1, and February 15, so as to have only days for which both Antarctic and Christchurch records were complete, we obtain the following results for the *hourly* ranges:—

	Declination.		Horizontal Force, in $\gamma$ .
	Arc.	Equivalent in $\gamma$ .	
Antarctic mean . . . . .	28·2	54	20·5
Christchurch mean . . . . .	1·04	6·9	3·1
$\frac{\text{Antarctic}}{\text{Christchurch}}$ ratio =	27·2	7·9	6·7

The enormous disparity between the Antarctic and Christchurch results is partly due, of course, to the fact that the range of the regular diurnal inequality is so much larger at the former station. But this only accounts for part of the difference, as may readily be seen by reference to the hourly values on term days given in "Physical Observations," pp. 175-178. The range of the regular diurnal inequality derived from a number of days, even quiet days, is always materially less than the arithmetic mean of the ranges from the individual days, the difference being greater the more disturbed the days. Thus the ratio of the range of the regular diurnal inequality at Winter Quarters to that at Christchurch will be less than the ratio derived when instead of the diurnal inequality ranges one takes the arithmetic mean of the ranges on individual days.

In the Physical Observation tables there are 16 days for which Declination ranges are given at both stations and 12 for which Horizontal-Force ranges are given (the curve not being beyond the limit of registration). Deriving arithmetic means from these, we find the following results for the *daily* ranges:—

	Declination.	Horizontal Force.
Antarctic . . . . .	84	7 62
Christchurch . . . . .	6·8	25·8
$\frac{\text{Antarctic}}{\text{Christchurch}}$ ratio =	12·4	2·4

The excess of the Antarctic figures is here very much less than for the hourly ranges.

§52. Plate XI gives a copy of a quick-run record obtained during a solar eclipse on September 21, 1903 (September 20, G.M.T.). According to Mr. BERNACCHI'S calculations the local times of the beginning, the central phase, and the end of the eclipse were respectively 3.40 p.m., 4.38½ p.m., and 5.37 p.m. The quick run was started at about 3.39 p.m. and continued until 5.46 p.m. The curves shown extend from 3.39 p.m. to about 5.39 p.m. They are copies taken with the Schmidt tracer, retaining the original scales for the ordinates, but reducing the time scale about 25 per cent.

The curves are shown in two portions, the upper panel representing the earlier half. The base lines  $D_0D_0$  and  $H_0H_0$  have been shifted from their positions in the originals so as to bring them within the range of the plate. The Declination, or D, curve and the Horizontal-Force, or H, curve cross one another in the second panel. The Declination scale is shown on the left, the Horizontal-Force scale on the right. The Vertical-Force curve to the eye was practically a straight line and so has been omitted along with the corresponding base line and the temperature curve to avoid confusing the trace.

The primary reason for reproducing the curves is that it is a question of interest whether an eclipse of the sun does exercise an appreciable influence on the variation of the magnetic elements. On various occasions there have been schemes of special observations during eclipses, and several authorities have been inclined to think that the results have shown a diminution in the changes as compared to those ordinarily encountered at the same hour of the day.

The curves in Plate XI show considerably more disturbance than those on June 15 and July 1, 1902, in Plates IV and V. They answer, however, to a time of year when the changes, both regular and irregular, were larger. It can be readily realised how useful open time-scale curves like these might prove for comparing disturbances of considerable magnitude at different stations.

§53. Plate XII gives an example of a series of regular waves, or "pulsations" as they have been very appropriately termed by Dr. VAN BEMMELN. The curves are exact copies of Antarctic quick-run curves of February 2, 1903. The letters D, H, V, T have their usual significance, the base lines being distinguished by the suffix 0. The scale values appear at the left-hand side.

The pulsations are most apparent in the Horizontal-Force curve between 9.10 and 9.25 p.m. But they may be detected—at all events in the original—throughout most of the H curve between 9 and 10 p.m., and can be recognised distinctly in the D curve about 9.15 p.m.

The special feature of pulsations is that they represent wave-like oscillations of force not varying much in amplitude and of at least approximately constant period during a considerable number of wave periods. In the present case there seem to be about 19 complete periods in 1 cm., and, as the time scale is about 240 mm. to the hour, the period is accordingly about 8 seconds.

Very short-period pulsations cannot be seen except in open time-scale curves, but pulsations of 2 or 3 minutes' period are not infrequently seen in ordinary curves from Kew pattern magnetographs. The Eschenhagen type of magnetograph is better adapted for showing pulsations, but the Antarctic conditions were so disturbed that pulsations with periods of 2 or 3 minutes would be difficult to recognise

with certainty. There was, perhaps, only one slow-run trace on which they were distinctly recognisable, that of August 6, 1902. On that day pulsations were distinctly visible in both the D and H curves during most of the time between 8 a.m. and 3.30 p.m. They were distinct enough at times, the day being unusually free from large disturbances, to admit of an approximate determination of the period from both the D and H curves. The results obtained showed no certain variation in the period, the mean obtained being 1.9 minutes, *i.e.* there were about 32 complete pulsations in the hour.

Several quick-run curves showed pulsations of short period. On June 16, 1902, pulsations were visible in the D and H curves between 8.30 and 8.40 p.m., having a period of about 27 seconds, and again with about the same period from 10.30 to 10.40 p.m. On August 15, 1902, pulsations appeared at intervals in both the D and H curves from 11.30 a.m. to 2.10 p.m. For 8 minutes, from 11.40 to 11.48 a.m., they had quite a considerable size, the maximum value of the double amplitude being at least 8 mm. (*i.e.* 12') in D and 6 mm. (8.4 $\gamma$ ) in H. During most of the time the amplitude was no larger than in Plate XII. The periods derived from the D and H curves were the same, about 7½ seconds, and appeared independent of whether the amplitude were large or small. This, of course, strongly supports the view that the largeness of the amplitudes between 11.40 and 11.48 a.m. was due to natural as opposed to instrumental causes.

On August 16, 1902, exceedingly small but very regular pulsations with a period of 7 or 8 seconds could be made out in the H curve from noon to 1 p.m. At one or two points the edge of the D curve seemed also serrated, but the movements were too small to be certain of.

Pulsations were also visible in the H curves of September 1, 1902, from 2.35 to 4.20 p.m., and on those of September 16, 1902, from 10.5 to 11.0 p.m. On both occasions the period was about 8 seconds. On September 1 the D curve also showed a trace of pulsations. On September 16 there seemed a faint indication of minute pulsations in the H curve later in the day between 3.0 and 3.20 p.m.

The above are the only cases in which pulsations were detected. As to whether they are more or less numerous in the Antarctic than elsewhere it would be impossible to say without a very minute investigation. It was really only when the magnetographs were quick run that pulsations were at all likely to be detected. The number of hours' trace in the Antarctic from quick-run curves was approximately 130, but this represents but a very small fraction of the time during which the magnetographs were in action.

§54. The curves in Plate XIII represent one of the quietest times, if not the very quietest time experienced in the Antarctic. The time represented is from 11 p.m. on June 27, 1903, to 9 a.m. on June 28. The slight movement that is apparent in the V curve is mainly due to temperature, there being a slight rise of temperature towards the end of the period. There were only 2 or 3 days' curves which even distantly approached those shown for quietness. Undisturbed as the D and H curves on June 27-28 are, when considered relatively to other Antarctic curves, they display a practically continual succession of small movements such as would not appear on an ordinary quiet day at Kew. The curves at Christchurch corresponding to those in Plate XIII were also very quiet. At Kew the time was also distinctly quiet, but not more so than on an average quiet day.

In the evening of the same day there was a large disturbance in the Antarctic, which is described later.

## CHAPTER VIII.

## RECORDS OF DISTURBANCES FROM CO-OPERATING STATIONS AND THE ANTARCTIC.

§55. What I had seen of the quick-run curves, obtained at Kew on the international term days of 1902 and 1903, made me anticipate that, so far as the inter-comparison of disturbances at different stations was concerned, the term-hour data were likely to prove of little service. Examination of the results obtained elsewhere, so far as available, and of the Antarctic records only served to confirm this. Accordingly I came to the conclusion that if any comparison of disturbances was to be carried out, additional data must be obtained. With this object, a list was made of days during 1902 and 1903 on which it appeared probable, from a consideration of the Kew and Antarctic curves, that comparative data from different stations would be valuable, and in January, 1905, a circular was issued, in the name of the Royal Society's Magnetic Committee, requesting that copies of the magnetic curves obtained on the days in question should be transmitted. This was sent to Dr. C. C. FARR, Director of Christchurch Observatory, New Zealand; Mr. C. T. F. CLAXTON, Director of the Royal Alfred Observatory, Mauritius; and to Mr. N. A. F. MOOS, Director of the Colaba Observatory, Bombay. These gentlemen all gave favourable consideration to the request, and sent home a number of most valuable records. The copies received from Christchurch and Colaba were photographic, those from Mauritius were tracings of the original. After considering all the material, I made a selection of the disturbances which presented most points of interest, and these are dealt with here. Even in 1902 the Kew curves, especially those of Vertical Force, were sensibly influenced by electric-traction currents, and accordingly application was made to Mr. E. KITTO, Superintendent of Falmouth Observatory, for the loan of the Falmouth magnetic curves for the days selected. Mr. KITTO and the Committee of the Falmouth Observatory responded favourably to this request so far as was possible. The Falmouth Vertical-Force magnet was unfortunately out of action during part of 1902, so that the information for that element during this time was derived from Kew alone. So far as the disturbances here considered are concerned, the differences between the Kew and Falmouth curves are mostly infinitesimal. In general, I measured both sets of curves. In the discussion I chiefly use the Kew measurements, but the plates show the Falmouth curves. It will be most convenient to describe first the plates dealing with curves from Falmouth, Colaba, Mauritius, and Christchurch, and then the plates dealing with the corresponding Antarctic curves and some additional ones.

## FALMOUTH, COLABA, MAURITIUS, AND CHRISTCHURCH DISTURBED CURVES.

§56. The magnetographs in use at Falmouth, Colaba, Mauritius, and Christchurch are of what is known as the "Kew" pattern. The time scale of the present Kew magnetograph is 1 hour to 0.6 inch (15.25 cm.), and this, presumably, was what was aimed at in the case of the magnetographs at the four stations mentioned above. As a matter of fact, the time scales, though very nearly equal, are not absolutely so. Still, the difference is so small that it does not readily catch the eye when the curves are juxtaposed, unless one extends the comparison to a large number of hours. This enables an effective comparison to be readily made without modifying the scale values.

The curves in Plates XIV to XXI were actually derived from copies of the curves received from Falmouth, Colaba, Mauritius, and Christchurch, which were made with the Schmidt curve tracer. The tracing was done at Bushy House by Mr. BROOKES, under the supervision of Mr. F. J. SELBY. The scales, whether of ordinates or of abscissæ, can be altered with the Schmidt tracer at the will of the operator, but, as a matter of fact, no intentional departure was made from the scales in the original curves. The tracings were made on separate sheets of paper, which were then arranged one below the other. In the originals the time is shown by breaks occurring every 2 hours in the time line, either at the even or at the odd local hours. The original time lines were dispensed with and replaced by others in which hours G.M.T. are indicated by short transverse lines. These lines were put on with considerable care, but they cannot claim to be more than approximately correct.

Further, ingenious as the Schmidt machine is, no *ordinary* operator can produce with it an absolutely perfect copy of the original. It is also not so well adapted for use with the broad trace of the Kew pattern magnetograph as the finer trace of the Eschenhagen instrument. It can deal, moreover, much less satisfactorily with rapid to-and-fro movements than with those of a rounded character. Thus Plates XIV to XXI are more appropriate for general descriptive purposes than for any minute investigation of details with a view to numerical calculations, and no use has been made of them for the latter purpose. Partly for this reason, and partly with a view to avoiding an excessive multiplication of lines, the ordinate scales are shown only at the left-hand margin of the curves. The Horizontal- and Vertical-Force scales varied slightly with the time, but the following values are sufficiently close considering the nature of the curves:—

	Value of 1 mm. of ordinate.		
	Declination.	Horizontal Force.	Vertical Force.
Falmouth . . . . .	1.1	5.0	5
Colaba . . . . .	1.1	5.1	16.5
Mauritius . . . . .	1.1	2.9	5.0
Christchurch . . . . .	1.1	4.6	2.7 to 3.2

At all four stations the Horizontal-Force curves were those which were most affected by disturbances, whilst the Vertical Force ones were the least affected. Thus the curves shown are mostly those of Horizontal Force.

As indicated by the scale figures and by the arrows, there is considerable variety in the procedure adopted at the different stations. At Falmouth and Colaba, as at Kew, movement up the sheet denotes increase in all three elements. At Mauritius, movement up the sheet means increase in Declination, but diminution in Horizontal or Vertical Force. At Christchurch, movement up the sheet means decrease in all three elements. In deciding, as I eventually did, not to invert any of the traces, I was influenced by several considerations.

In the Antarctic curves, which it was decided to reproduce photographically—the difficulty of obtaining reasonably accurate results with the Schmidt tracer appearing excessive—movement up the sheet meant increase only for the Vertical Force. The three elements were in this case all on one sheet, and to have retained one unaltered while inverting the others presented serious difficulties. Thus absolute uniformity of procedure was unattainable unless one was prepared to take a great deal of trouble, and to take much trouble appeared justifiable only if it were clear that the result was a decided gain. On the other hand, reflection showed that in any case only a semblance of uniformity was obtainable. Declination is westerly at Falmouth and Mauritius, but easterly at Colaba and Christchurch, thus an increase in the element means movement of the north end to the west at the two former stations, but to the east at the latter two. In the Antarctic Declination was easterly, but exceeded 90°; thus increase of the element meant increase of easterly Declination, but movement of the N. pole to the west. At Falmouth and Colaba, where the N. pole dips, increase of Vertical Force means an additional force on the N. pole directed towards the Earth's centre; but at Mauritius and Christchurch, where the S. pole dips, it means a force urging the N. pole from the Earth's centre. As regards the Horizontal Force, the magnetic Meridians of the various stations varied from 18° W. at Falmouth to 16° E. at Christchurch and 152° E. in the Antarctic. Thus the planes in which the Horizontal Force is measured were related in very different ways to the local astronomical Meridian.

Finally, there was the consideration that horizontal and vertical, east and west, are terms of purely local significance, and indicate directions whose relations to any one system of rectangular axes vary with the latitude and longitude of the station.

§57. Plates XIV to XXI follow the chronological order. Plate XIV (compare Plate XXII) shows a disturbance which seems to have been felt all over the world. It lasted for practically 8 hours, the termination being nearly as clearly indicated as the commencement. The three lower, Horizontal-Force, curves show

a sudden commencement at about 11.59 a.m., G.M.T., on May 8, 1902. At Kew, Falmouth, Colaba, Mauritius (curve not shown), and Christchurch the initial change in  $H$  was an increase, which continued for about 10 minutes. The Falmouth curve in Plate XIV shows a short stoppage of the upward motion at about 12.4. This stoppage actually existed, being as apparent in the Kew as in the Falmouth curve, but it has been somewhat exaggerated in the tracing. The original Colaba curve gives just a suggestion of a corresponding stoppage. It is not shown in the Mauritius curve (a tracing), nor on the Christchurch curve. The latter, however, is somewhat fuzzy, and a very short stoppage might not leave a visible effect. To the nearest  $1\gamma$  the total increase in  $H$  from 11.59 a.m. to 12.9 was  $18\gamma$  at Kew,  $19\gamma$  at Colaba,  $9\gamma$  at Mauritius, and  $9\gamma$  at Christchurch. The corresponding changes in Declination (W. to west, E. to east) were at Kew  $1'3$  W., Colaba  $0'7$  E., Mauritius  $0'7$  W., and Christchurch  $0'2$  E. The disturbance took place at an hour when the regular diurnal change at Kew and Falmouth was rapid and the elimination which was made of the regular diurnal change was, doubtless, only approximately correct.

The changes in Vertical Force were at Colaba  $-7\gamma$  and at Mauritius  $+5\gamma$ . No Falmouth  $V$  curve was available. At Kew no change was detected, but a small change might have been hidden by electric-tram currents. At Christchurch the Vertical Force was, if anything, diminished, but if so, only to the extent of about  $0.5\gamma$ . At Colaba the Vertical-Force scale was  $16.2\gamma$  to 1 mm., so that an error of  $0.2$  mm. in the measurement of the ordinate means an error of  $3\gamma$  in force.

The initial change of force at 11.59 a.m. is not the only one common to the different stations. A very similar movement, occurring from about 7.4 to 7.11 p.m., G.M.T., is prominent in the Kew, Falmouth, Colaba, and Mauritius curves, and seems recognisable also at Christchurch. This was followed by a decrease in  $H$ , which is very prominent at Kew, Falmouth, and Colaba, but which at Christchurch is interrupted by oscillations. We have here an excellent example of the difficulty of getting comparative results from different stations. To do this satisfactorily, one requires a movement practically continuous in one direction, occurring simultaneously in all the elements at all the stations. One can obtain a variety of such corresponding points—peaks and hollows as Dr. BALFOUR STEWART called them—on the Kew and Colaba curves, but when it comes to bringing in Mauritius and Christchurch it is comparatively seldom that turning-points common to all can be found. In the present instance only three movements could be found at all suitable for comparison. These answered to the intervals 11.59 a.m. to 12.9, 2.10 to 2.28 p.m., and 7.4 to 7.11 p.m., and even in their case one could not feel absolutely certain that the movements in all the elements at all the stations were really synchronous.

The magnetic storm illustrated in Plate XIV has received considerable prior attention owing to the fact that its commencement began within 4 or 5 minutes, possibly less, of the beginning of the eruption of Mont Pelée, which devastated St. Pierre in Martinique. This fact was pointed out by Dr. BAUER,\* dealing with magnetic curves from American observatories.

The shortness of the interval between the commencement of the magnetic storm and the eruption—not to speak of the character of the movements—showed that it was not a case of mechanical shock due to seismic waves, and Dr. BAUER's remarks suggest the possibility of a true magnetic action at a distance due directly to the eruption. This was, I think, only a suggestion. Dr. BAUER's final opinion on the subject I have not seen. My own impression is that the coincidence was merely accidental. The reasons for this view will appear later (§100).

§58. Plate XV shows Horizontal-Force movements referring to three different disturbances, those of August 20, November 6, and November 24, 1902.

The storm of August 20 was ushered in, like that of May 8, by a sudden movement. This commenced at 9.6 p.m., G.M.T., and terminated practically in 4 minutes. During this time  $H$  increased by  $14\gamma$  at Kew,  $10\gamma$  at Colaba,  $6\gamma$  at Mauritius, and  $4\gamma$  at Christchurch. The changes in the other elements were mostly almost too small to measure, being in  $D$   $0'6$  W. at Kew,  $0'2$  E. at Colaba,  $0'0$  at Mauritius, and  $0'6$  W. at Christchurch. In  $V$  there was an increase at Kew of about  $1\gamma$ , and a fall at Colaba of under  $2\gamma$ ; no change could be detected at Mauritius or Christchurch. The movements between 9.6 and 9.10 p.m. at the several observatories appeared synchronous, and there was no visible arrest of the movement corresponding to that seen in the Kew and Falmouth curves of May 8.

\* 'Terrestrial Magnetism,' vol. 7, 1902, p. 57.

The disturbance on November 6 had also a sudden commencement at about 3.52 p.m., G.M.T., but in this case the commencing movement was of a distinctly double character, this being very clearly shown by the Falmouth curve which is reproduced. The first movement in H was a decrease, lasting for about  $1\frac{1}{2}$  minutes, and it was followed by a notably larger increase. The upward movement will be seen to hesitate, and then diminish in steepness. The summit at Falmouth was reached about 3.58 p.m. The amplitude of the first change was about  $1\gamma$ , that of the second about  $9\gamma$ , but exact measurement of the first movement was difficult. The Falmouth D trace shows a corresponding oscillation, a movement of about  $0\cdot5$  W. being followed by a larger but slower movement of about  $0\cdot9$  E. There was no Falmouth V curve; no measurable change appeared in that at Kew. The H and D curves at Kew appeared identical with those at Falmouth.

On November 24, as appears from the lowest curve in Plate XV, there was a disturbance of considerable magnitude at Christchurch. It did not, however, have a very definite commencement, and identification of corresponding movements at Christchurch and Falmouth could not be satisfactorily carried out.

§59. Plate XVI shows what appears to have been the most outstanding commencement exhibited by any of the magnetic storms experienced during 1902-3. The top and bottom curves are Declination ones, the others are of Horizontal Force. In the latter element, the initial movement was an increase at all the stations whose curves were reproduced. The copy of the Falmouth curve in Plate XVI suggests the presence of a small tremor before the upward movement commenced, but this tremor is very doubtfully shown in the original, either at Falmouth or at Kew. Neglecting it, the initial movement commenced at 11.25, and lasted until 11.29 p.m. on April 5. In the case of the Declination, the commencing movement at Kew and Falmouth was unquestionably double. For the first half minute or so, there was a small easterly movement, and then a much larger westerly movement, culminating at 11.29 p.m. Comparing the conditions at 11.25 and 11.29 p.m., we have for the changes in the three elements the following approximate values:—

	$\Delta H.$	$\Delta D.$	$\Delta V.$
Kew and Falmouth . . . . .	$\gamma$ +41	$\gamma$ 3·3 W	$\gamma$ +5
Colaba . . . . .	+25	0·4 E	-8
Mauritius . . . . .	+18		
Christchurch. . . . .	+19	1·8 W	-2

Only Horizontal-Force curves were available for Mauritius.

Of the gaps apparent in the curves most are due to interruption of the trace by the time-shutter. The longer one at Mauritius represents the changing of the photographic paper.

The disturbance was most active between 2.30 and 5.30 a.m. on April 6th, but it was by no means large at any time, the Declination range at Kew and Falmouth being only about  $25'$ .

§60. Plate XVII shows some curves whose chief interest lies in connection with some Antarctic curves, which will be discussed presently.

The very symmetrical-looking movements shown by the D, H, and V traces at Christchurch, on June 19, 1903, occurred during a day which was otherwise very quiet.

The Christchurch curves of July 26, 1903, show what was for that station a very considerable disturbance. They illustrate what seems a general feature—the relatively small range of Vertical-Force disturbances at Christchurch, compared to those in the other elements.

The same phenomenon is also exhibited by the curves of Plate XVIII, which show the disturbances at Christchurch on August 22, 1903. This was one of the largest disturbances exhibited by the curves received from Christchurch. The storm showed no very definite beginning or end. The most distinctive movements are those occurring about 5 a.m. and 9 a.m. But even in their case the turning-points for the different elements do not synchronise satisfactorily, and no satisfactory comparison proved possible with the curves at other stations.

§61. Plate XIX refers to a storm recorded on August 25-26, 1903. It shows the D, H, and V curves for Christchurch, and the H curves for Colaba and Falmouth. The largest movements did not occur until nearly 2 hours after the commencement, and to bring the principal part and the beginning within the range of one plate the trace is omitted from about 3.30 to 6.0 a.m.

The Falmouth and Colaba traces show a sudden commencement. At Falmouth and Kew the commencement, like that of April 5, 1906, showed a distinct double movement, a very small diminution in H being followed by a large increase. The Declination curves at these two stations also show a double movement, a small easterly movement being followed by a somewhat larger but still small westerly one. The double movement occupied from 10.57 to 11.3 p.m. on the 25th, the to-and-fro movements occupying about equal times.

The Colaba H curve also shows at least a suggestion of a double movement, an increase of some size following a very small decrease, the two corresponding in time to the corresponding changes at Falmouth. The changes in the Colaba D and V curves are very small.

At Christchurch there was also a sudden commencement, though it is relatively inconspicuous. It is best seen in the D curve, where there was first a small movement to the east (*i.e.* down the sheet), from about 10.57 to 11.0 p.m., followed by a larger movement of similar duration to the west. Whether there was a double movement on the Christchurch V curve it is difficult to say, but there is at least an indication of a movement down the sheet, preceding the one distinctly visible up the sheet. There is also a distinct oscillation on the H curve, corresponding in time to that in the D curve. This was preceded by various small movements, which presumably were from a different source.

The results obtained from the measurements of the double movement were as follows :—

	10.57 to 11.0 p.m.			11.0 to 11.3 p.m.		
	$\Delta H.$	$\Delta D.$	$\Delta V.$	$\Delta H.$	$\Delta D.$	$\Delta V.$
Kew . . . . .	$\gamma$ -6	' 0.7 E	$\gamma$ 0	$\gamma$ +34	' 1.2 W	$\gamma$ 0
Colaba . . . . .	-1.5	0.2 E	0	+17	0.1 W	-2
Christchurch . . . . .	+1.4	0.2 E	0	-1.4	1.1 W	-2

The increments  $\Delta H$ , &c., here, as elsewhere, measure the *changes* during the interval specified. Thus at Kew, on the occasion in question, H fell  $6\gamma$  between 10.57 and 11.0 p.m., and then rose  $34\gamma$  between 11.0 and 11.3 p.m. At 11.3 p.m. H was thus greater by  $28\gamma$  than when the storm commenced. The change between 11.0 and 11.3 p.m. was very probably in part a recovery from that experienced between 10.57 and 11.0 p.m., but that is purely a matter of surmise; thus in the calculations subsequently made the movement from 11.0 to 11.3 p.m. is treated as an absolutely independent one.

§62. Plates XX and XXI relate to a storm of considerable size which occurred on December 13, 1903. At Falmouth, as Plate XX shows, a sudden commencement is distinctly visible in the D curve. There was a distinct double movement, first to the east from about 0.29 to 0.30 p.m., then to the west from 0.30 to 0.33 p.m., the westerly movement being considerably the larger. In the case of the H curve there were at the commencement several to-and-fro movements, of too small an amplitude to show details clearly. The principal part of the disturbance occurred from 6 to 10 hours after the commencement.

Plate XXI shows the changes in the Horizontal Force at Colaba and Mauritius corresponding to those at Falmouth. Both curves show a very distinct sudden commencement, the initial movement lasting from about 0.28 to 0.35 p.m. H was falling at both stations at the time when the disturbance began (at Mauritius H increases down the sheet), and it is not absolutely clear that the first sudden change may not have been a further decrease, but if so it was too small and instantaneous to be clearly visible. The increase, on the other hand, is very decided. Following this there was a large but wonderfully uniform fall in H, continuing for about six hours, in the course of which a decrease of over  $150\gamma$  was experienced both at Colaba and Mauritius. At Falmouth the synchronous change in H was also on the whole a decrease,



but it was much less uniform and was interrupted by numerous oscillations of considerable size. Again, while the force at Falmouth continued to fall on the whole until 8.30 p.m., a marked rise commenced at about 6.30 p.m. at the other two stations. At Mauritius and Colaba the most rapid and striking moments are those occurring from 8 to 10 p.m.

In this case the correspondence is much closer between the Colaba and Mauritius curves than between either of these and the Falmouth or Kew curves. At first sight the Colaba and Mauritius curves seemed to present a number of opportunities for comparing amplitudes at the two stations, but on further investigation this did not prove to be the case, the different elements not showing convenient synchronous turning-points.

#### ANTARCTIC DISTURBED CURVES.

§63. In the Antarctic, as already explained, all three elements and the temperature were recorded on one sheet. Thus at times of more than usual disturbance there was apt to be a good deal of intercrossing of curves, especially those of Declination and Horizontal Force. As a rule, however, the traces from the different elements differed in appearance to some extent, one being thicker or less exactly in focus than the others. Thus it was seldom that any serious doubt existed as to the identity of any particular portion of trace. The Vertical-Force trace was so much less open than the others, *i.e.*, the sensitiveness was relatively so low, that it usually showed very little range of movement. Even at times of high disturbance changes of ordinate exceeding 2 cm. occurred very rarely. Thus the Vertical-Force trace, VV in the plates, was almost always easily distinguishable. It bore at times a resemblance to the temperature trace TT—which had the same base line  $V_0V_0$ —but the movements in these two elements at times of magnetic disturbance were of such absolutely different types that confusion was impossible. One feature that often served to distinguish between the Declination trace DD and the Horizontal-Force trace HH was that the former was shown freely from one edge of the sheet to the other, whilst the latter became invisible at a considerable distance below the top edge of the sheet. This was due, as already explained, to the light being eclipsed by the Declination instrument. Exactly where the trace became invisible depended on the intensity of the light and the photographic conditions.

Whenever a trace died out gradually near the top of the sheet one knew it was that of the Horizontal Force. In the reproductions in the plates the letters D, H, and V appear whenever there seemed any risk of confusion. The suffixes 0, as before, distinguish the base lines.

In the originals the base lines were interrupted for a short interval every hour. These breaks indicated hour intervals with the usual precision, but the eclipsing arrangement was not usually so set as to act exactly at the hour of local (or Greenwich) time. To determine the absolute time one had to refer to the times of starting or stopping the registration. Mr. BERNACCHI always entered these times in a notebook, and he transferred them with his estimate of the error of the watch with which they were taken to the sheets themselves. Suppose, for instance, the exact local time of starting to be 10.30 a.m., and 15 mm. trace to be recorded before the first break began, and suppose the interval between the left- (or between the right-) hand sides of the hour breaks to be 20 mm. (*i.e.* 1 mm. to 3 minutes). Then the time to which the left-hand side of the first break corresponded was 10h. 30m. +  $\frac{15}{20} \times 60$  minutes, or 11h. 15m.

Supposing the magnetograph clock to have a negligible rate, the breaks in the above case would all commence at 15 minutes after the hour throughout the 24 hours, and the cross lines indicating the exact hour would all be drawn at 15/3 or 5 mm. to the left of the left-hand side of each break.

Usually regard was had mainly to the time of commencement of registration. The clock rate was normally very small, but on a few occasions when it was large, or when there was some special cause of uncertainty, use was also made of the time of stopping. Of course the position of the last hour mark relatively to the end of the trace was always noted, but very exact measurements were not made unless there was some apparent inconsistency.

What accuracy can be claimed for the hour marks it is a little difficult to say. Whether owing to variations of temperature—which were unusually large—in the magnetograph room, or to differences in the shrinking or stretching of the photographic paper, the interval between the hour marks varied slightly from day to day, and was seldom exactly 20 mm., usually somewhat less. There were even sometimes

visible variations in the course of the 24 hours. The marks were put on by an assistant using a millimetre scale and a fine pencil. If measurement showed the result of his first attempt to be unsatisfactory, the mark was rubbed out and a fresh one put on. Great care was used, but, of course, absolute accuracy cannot be claimed. The different elements were dealt with at different times, and to some extent by different people, and the time marks put on the three base lines were seldom *absolutely* in a straight line. There are several reasons for this quite apart from human liability to err. The dots of light were not all the same size, and none, of course, were mathematical points. They might not be all absolutely in a line, and the paper was doubtless at times not absolutely even on the cylinder, while the stretching or shrinking of the paper might not be the same at all parts of the sheet. Apart from the hour marks, measurements of time suffered from the fact that the curve and the corresponding base line were often very wide apart. If a measuring scale is imperfect, or if the observer does not get its base line to be absolutely colinear with the curve base line, an error comes into the measurement of the time which is proportional to the length of the ordinate. Uncertainties on this ground were very much greater for the Antarctic curves than for those at most of the co-operating observatories. The reason for dwelling on these points is that any uncertainty in the time increases the difficulty of being absolutely sure of the identification of corresponding rapid movements at different stations. As we shall presently see, there was sometimes a double to-and-fro movement in the Antarctic when only a single movement was clearly visible elsewhere, and a 2- or 3-minute mistake in the time might suffice to lead to a mistaken identification. All I can say is that in attempting these identifications I had regard to the original hour breaks and all the information available as to both stopping and starting. For the intercomparison of disturbances, if that had been the only object, it would have been more convenient to have used Greenwich time, as in the case of Falmouth, Colaba, Mauritius, and Christchurch. But to show Greenwich time would have entailed putting on a second set of hour marks, because those originally put on gave the local time which was employed in all the hourly measurements and tabulation tables, except those for the international term days and hours. Thus the times shown in all the Antarctic disturbed curves now to be discussed are local time (termed L.T.). The corresponding Greenwich times may be obtained by subtracting 11h. 7m. In practice it is simpler to add 53 minutes, converting p.m. into a.m., and a.m. into p.m. of the previous day.

The original Antarctic curves were placed in contact with a photographic sheet, and a negative was obtained by transmitted light. Writing made on the original, and unnecessary details as to times, &c., were removed from the negative. The positive from this was intensified, the faint parts being carefully inked in, and the hour gaps in the base lines filled in. The plates are reproductions from these positives. The reproduced curves cannot claim to be absolutely identical with the originals, but the differences between them are much less than if the originals had been traced in the same way as the term-hour curves were. Exact photographic copies of the originals were hardly feasible, because during the very rapid movements characteristic of the larger disturbances the trace was naturally faint. In fact, it was not infrequently so faint that it had to be traced over in the original to be sufficiently clear to be measured. These tracings were mainly done by Mr. BERNACCHI, and to distinguish the Declination and Horizontal Force traces at times he had been obliged to use coloured inks.

The base line values and the scales are shown at the margins, the information for one of the elements being on one margin, that for the two other elements on the other. To assist in distinguishing between the different curves all the traces stop just short of a scale-value line, except that of the base line for the element concerned. Arrows are added to mark the direction in which each element increases (V up the sheet, D and H down the sheet), though that can be inferred at once from the scale-value figures. The short intervals on the D scale represent 10', only the 30' intervals are numbered. On the H scale 10 $\gamma$  intervals are shown, the 50 $\gamma$  intervals being numbered. On the V scale 100 $\gamma$  intervals are shown, but usually only the 200 $\gamma$  intervals are numbered; the procedure varies according to the openness of the scale.

§64. Plate XXII gives the Antarctic record of the disturbance of May 8, 1902, corresponding to the records at the co-operating stations shown in Plate XIV. As elsewhere, there is an unusual definiteness about the end as well as the beginning of this storm, it being followed as well as preceded by an unusually quiet time. As already mentioned, it lasted almost exactly 8 hours. At the co-operating

stations, it will be remembered, the notable feature at the commencement was the rise in the Horizontal Force. In the Antarctic the Horizontal-Force trace—whose sensitiveness is nearly four times that of the corresponding traces at Falmouth and Colaba—shows, at first, only the most trifling of movements. It is the D curve which is the disturbed one. This shows a very marked *double* movement. There is first an increase in D (*i.e.* movement down the sheet), commencing at 11.6 p.m., L.T. (11.59 a.m., G.M.T.), and lasting about 4 minutes. This answered, apparently, to the increase in the Kew and Falmouth H curves from the commencement up to the time when the curves show a temporary arrest in the movement. Following this, however, is a larger swing in the opposite direction. The second summit was not reached until 2 or 3 minutes after the conclusion of the increase in H at the co-operating stations, but the movement during the last 3 minutes of the movement was small. The peculiar nature of the Antarctic phenomena is, perhaps, best brought out by contrasting the changes which occurred there during the two portions of the double movement, from 11.59 a.m. to 12.9, G.M.T., with those which occurred synchronously at Kew.

	First phase, 11.59 a.m. to 12.3, G.M.T.			Second phase, 12.3 to 12.9, G.M.T.		
	$\Delta H.$	$\Delta D.$	$\Delta V.$	$\Delta H.$	$\Delta D.$	$\Delta V.$
Antarctic . . . . .	$\gamma$ +1	+15	$\frac{\gamma}{0} + 6$	$\frac{\gamma}{-2}$	-27	$\frac{\gamma}{+6} - 9$
Kew . . . . .	+9	0.4 W.	0	+9	0.9 W.	0

At the co-operating stations, movements from 2.10 to 2.28 p.m., G.M.T., and from 7.4 to 7.11 p.m., G.M.T., were fairly identifiable. In the Antarctic there are fairly recognisable turning- or stopping-points at 2.10 and 2.28 p.m., G.M.T., in all the elements, and a comparison was made between the changes of force at the various stations during these 18 minutes, the results of which are given afterwards. It should be noticed, however, that whilst 2.10 p.m. (1.17 a.m., L.T.) is a peak, and 2.28 p.m. a prominent hollow, there is an intervening peak at 2.20 p.m. (1.27 a.m., L.T.), so that in the Antarctic the change from 2.10 to 2.28 p.m., G.M.T., was not persistent in one direction.

Owing, presumably, to the rapidity of the movements, the Antarctic D trace became invisible during several minutes both before and after 7.11 p.m., G.M.T., so what happened from 7.4 to 7.11 p.m. in that element is uncertain. The largest of the recorded D and H movements took place between 4.25 and 5.50 p.m., G.M.T. (3.32 and 4.57 a.m., L.T.), whilst the largest V movements took place between 6.51 and 7.30 p.m., G.M.T. (5.58 and 6.37 a.m., L.T.). These were also the times when the largest movements occurred at the co-operating stations.

§65. Plate XXIII shows what was, on the whole, a very quiet state of matters for the Antarctic. Its interest lies in the fact that the prominent oscillation in the D curve, which took place between 8 and 9 a.m., L.T., on August 21, synchronises apparently with the sudden change in H at the co-operating stations shown in the top curves of Plate XV. Whilst there can be little doubt that the movement in the Antarctic is due to the same source as the commencing movement at the co-operating stations, there is a doubt as to what corresponds to what. At all the co-operating stations H showed a sudden rise, commencing at from 9.6 to 9.7 p.m., G.M.T., on August 20, and continuing until 9.10 p.m. Before 9.6 p.m. the curves were very quiet. After 9.10 p.m. H diminished, but only very slowly. In the Antarctic the D curve shows a sudden movement up the sheet which lasts 4 minutes, but it seems to commence at 8.10 a.m., L.T. (9.3 p.m., G.M.T.), and it is immediately followed by a reverse swing of larger magnitude also lasting 4 minutes. This, in its turn, is followed after a minor oscillation by a movement up the sheet, bringing the D trace back to the position it occupied originally. The V curve shows an obvious double movement, but the first obvious movement (down the sheet, or decreasing force) synchronises with the second, not the first movement in D, and the second, or upward, movement follows thereafter.

However, on looking closely at the Antarctic V curve, it will be seen that its trend during the 4 minutes preceding the downward movement commencing at 8.13 or 8.14 a.m., L.T., is not quite in a line

with the immediately preceding portion. Prior to 8.10 a.m., L.T., the V trace was sloping gently down the sheet, representing most probably a gradual rise in temperature, which can, however, only be inferred, as the temperature trace got beyond the edge of the sheet at 2 a.m., L.T. But from 8.10 to 8.14, L.T., the slope is slightly the other way. The measurements of the original gave an increase of about 0.1 mm. of ordinate during this 4 minutes, answering to 1.2γ. Thus we have apparently a real oscillation in all three elements, from approximately 8.10 to 8.18 a.m., L.T. (9.3 to 9.11 p.m., G.M.T.), for the magnitude of which I find:—

	ΔH.	ΔD.	ΔV.
First phase (9.3 to 9.7 p.m., G.M.T.) . . . . .	-1.5 <sup>γ</sup>	-19.8	+1.2 <sup>γ</sup>
Second phase (9.7 to 9.11 p.m., G.M.T.) . . . . .	+4.9	+30.9	-6.3

The time of commencing the second phase in the Antarctic is, if anything, before 9.7 p.m., G.M.T., whilst the times of the commencement of the increase in H at Kew, Falmouth, and Colaba are all, if anything, later than 9.6. Thus the evidence certainly points to the conclusion that it is the second phase in the Antarctic which answers to the commencement seen elsewhere. If so, it is certainly remarkable that what seems to a considerable extent a recovery from a sudden disturbance should exert an effect visible all over the world, whilst the effect of the preceding disturbance is visible only in the Antarctic.

§66. Plate XXIV shows a disturbance corresponding to the second of those appearing in Plate XV. In this instance the commencing movement was distinctly double at Falmouth and elsewhere, and in the Antarctic this oscillatory character is even more clearly shown in the H and V traces. Taking the H curve, we have first a sudden movement down the sheet (increase of H) commencing at 2.59 a.m., L.T., on November 7 (3.52 p.m., G.M.T., on November 6) and lasting about 1½ minutes. This is followed by a reverse motion of more than double the amplitude, occupying about 10½ minutes. The first movement, so far as can be judged, is exactly synchronous with that at Falmouth, but the second movement somewhat overlaps the corresponding Falmouth movement. The Falmouth trace is rounded at the top, but a slight fall in H is visible before the corresponding turning-point appears in the Antarctic curve. The Antarctic V trace shows a sudden rise synchronous with the first movement in H, followed by a larger fall. The second turning-point occurs, however, about two minutes earlier than that in H, and so corresponds more nearly to the summit of the Falmouth H curves. What happened to the Antarctic Declination is uncertain, as the trace is invisible during the most rapid part of the H movement. The fact that the D trace is invisible suggests that the movement was even larger than that in the H trace; so presumably a to-and-fro movement of large amplitude occurred.

When the D trace becomes visible it shows two small peaks in rapid succession. It is the second of these that answers to the turning-point terminating the second movement in H. The first peak preceded this by three minutes.

The amplitudes of the first two movements in H and V are as follows:—

	ΔH.	ΔV.
First movement . . . . .	+22 <sup>γ</sup>	+6 <sup>γ</sup>
Second movement . . . . .	-57	-16

The H and V magnets had at this time their highest sensitiveness, so that the large size of the apparent movements in these traces requires to be discounted when compared with that in other disturbances. The D trace, however, had the same sensitiveness as usual. Thus the fact that so much of the D trace is lost—partly through going off the sheet, partly from being too faint to be visible—is evidence that in the Antarctic the storm was a very considerable one, including some very rapid changes of force. At Kew

and Falmouth it was of a very trifling character, the range being under 6' in D and under 20 $\gamma$  in H. In the Antarctic the visible ranges, on the other hand, are 2° 13' in D and 80 $\gamma$  in H, and to all appearance the D range at least was considerably larger.

§67. Plate XXV shows the disturbance in the Antarctic on November 24, 1902, corresponding to the disturbance at Christchurch, shown in the lowest curve of Plate XV. This disturbance, though of considerable size, had no very outstanding features either in the Antarctic or elsewhere. It occurred at a time when there was a good deal of general disturbance, and the day was not very exceptional as compared to adjacent days. The D curve, it will be seen, crossed from one edge of the sheet to the other—representing 4° 50'—and trace was lost at both sides. The range in D is, however, partly due to the regular diurnal variation, which doubtless contributed considerably to the movement shown between noon and 5 p.m. (L.T.). The H curve was off the sheet most of the time from noon to 4.30 p.m. (L.T.) on the 24th and the range probably largely exceeded that actually shown, 149 $\gamma$ .

The sensitiveness of the V magnet was less than half of what it possessed on November 7. The movement shown on the trace represents about 171 $\gamma$ , but a portion of this is due to temperature. Between 11.30 a.m. (L.T.) on the 24th, when the minimum appears on the V trace, and 9 p.m. (L.T.) on the 24th, when the maximum appears, temperature fell 0°·4 C. Allowing for this change of temperature, the range is reduced to 154 $\gamma$ .

The identification of the D and H curves during the early part of the time covered by Plate XXV presented some difficulties. It answers to the earlier part of the photographic sheet for the day November 24–25 (L.T.). The interval between the putting on of this sheet and the taking off the previous one was unusually long, exceeding an hour. The disturbances during the early part of the 24th covered by the preceding sheet were very large, the to-and-fro oscillations in both D and H, if not so large as later in the day, being more numerous and rapid. At the time when the sheet was taken off, the D trace had been off the sheet for over an hour, while the H trace, after being repeatedly beyond both limits of registration, was near the centre of the sheet.

On the sheet for November 24–25 the first absolutely clear discrimination between the D and H traces is afforded by the fact that the trace marked D did not become invisible at 5 p.m. This enables one to identify the trace marked D as certainly Declination back to before 2 p.m. Prior to that one had to be guided by the appearance of the traces, and on that particular day there was no very marked difference as regards thickness of trace or definition. As to whether the small portion of curve which just came on the sheet at about 0.20 p.m. (L.T.) represented D or H it was impossible to say.

§68. Plate XXVI shows disturbances in the Antarctic on April 6, 1903, the same date as those of Plate XVI.

Plate XXVI represents two portions of curves, the first extending from midnight on April 5 to 4.15 a.m. (L.T.) on the 6th, the second from 9.20 a.m. to 3.10 p.m. on the 6th. The intermediate portion of curve was fairly quiet, and was omitted to bring the whole within the compass of one plate. The disturbances in the earlier portion of curve have a range of 63' in D, 112 $\gamma$  in H, and about 55 $\gamma$  in V (the temperature effect in this instance is small). They answer to disturbances occurring from 10 to 6 hours earlier than those represented on Plate XVI. At Kew, the largest of these movements is represented by a bay on the H curve, the element first rising, and then falling about 30 $\gamma$ . This answered in time, at least very approximately, to the movement shown on the Antarctic H curve between 3 and 4 a.m., L.T., but was of only about one-third the amplitude. The second portion of curve in Plate XXVI answers to the earlier portion of Plate XVI. What answers to the sudden commencing movement from 11.25 to 11.29 p.m., G.M.T., at Falmouth and the other co-operating stations, is apparently the sudden movement up the sheet in D and H, and movement down the sheet in V, shown in Plate XXVI as commencing at 10.32 a.m., L.T., and lasting 4 minutes. But while the commencing movement at the co-operating stations was much more prominent than the movements immediately following it, the reverse is true of the Antarctic, where the commencing movement was immediately followed by an equally rapid and considerably larger movement in the opposite direction. Towards the end of the second movement the rapidity of change diminished notably in D and V. What happened in the case of H is uncertain, as the trace went off the sheet, but the movement terminated earlier than was the case in V or D. The double movement in the H trace has

many points of similarity to that shown at the commencement of the storm of November 7, 1902. It is, however, a much larger movement, and is exactly opposite in direction, the first movement on April 6, 1903, representing decrease in all the elements, whilst that on November 7, 1902, represented increase at least in H and V. The range shown in the second portion of Plate XXVI is  $3^{\circ} 45'$  in D,  $102\gamma$  in H, and  $105\gamma$  in V, but as the D trace got off the sheet towards the end of the time, and the H trace was off for  $2\frac{1}{2}$  consecutive hours, the range in these two elements may have considerably exceeded that shown. The end of the traces in Plate XXVI answers to the end of the photographic sheet of April 5-6. The commencing portion of the next sheet (not reproduced) shows a similarly disturbed set of conditions, lasting until nearly 2 a.m., L.T., on the 7th.

§69. Plates XXVII to XXXI afford illustrations of what I have called the "special type of disturbance," which is discussed in detail in Chapter X. Plate XXVII is a good example of moderate size occurring on June 19, 1903. The disturbance referred to is that shown from about 6.40 to 7.20 p.m., L.T. During what I have termed the "first phase"—extending from 6.40 to 7.1 p.m.—the D and H traces go up, the V trace down the sheet, *i.e.* all three elements diminish. During the second phase the movements are in the reverse direction, *i.e.* the three elements increase. In this individual case the return D and H movements are less than the original movements, something occurring to check them. The return movement in the V curve exceeds the first movement, as nearly always happened. The curves show the continual minor oscillations characteristic of practically all the Antarctic D and H records. Thus it is difficult to assign a very definite time for either the beginning of the first phase or the conclusion of the second. Most likely the duration of the phases is underestimated. The H trace went beyond the limits of registration—apparently just exceeding them—about 7 p.m., L.T. The summit in the H curve must have occurred a few minutes after the hour 7.1 p.m. accepted above for the end of the first phase. The curve shows, however, a peak somewhat earlier, about the time of the turning-points in the D and V curves. The behaviour of the H trace during the special type of disturbance was less uniform than that of the other two elements—the first change in H being sometimes an increase—and in fixing the end of the first phase more attention was given to the two other elements, especially to V.

The changes in H during the special disturbance of June 19, though looking much larger to the eye than those in D, represented in reality considerably less change of force. Thus, during the first phase, the change shown in H represents a decrease of  $91\gamma$ , but the corresponding fall in D was  $72'$ , answering to a force of about  $138\gamma$ . The second phase movement in V, relatively insignificant as it looks, represents an increase of  $53\gamma$ . After reaching the maximum shown at about 7.20 p.m., the V curve shows only a very gradual diminution of ordinate, as if the cause of the special disturbance, whatever that may be, had an effect on the Vertical Force which required time to disappear.

Synchronously with the special disturbance in the Antarctic on June 19, 1903, there was a well-marked, though much smaller movement at Christchurch, shown in the upper curves of Plate XVII. The prominent crest in the Christchurch D curve, appearing a little before 8 a.m. (G.M.T.), seems to answer to the end of the first phase in the Antarctic movement.

§70. Plates XXVIII and XXIX show movements of a very similar character to that shown by Plate XXVII, occurring on successive days, June 28 and June 29, 1903. The estimated times of ending for the first phase were: for June 28, 7.54 p.m., L.T.; for June 29, 8.33 p.m., L.T. The occurrence of closely similar movements in Declination on two successive days has been remarked on before. In the 9th edition of the 'Encyclopædia Britannica'\* Dr. BALFOUR STEWART refers to a discussion by SENOR CAPELLO of a series of cases in which such changes appeared in the Lisbon magnetic curves, and mentions that he had observed correspondences of similar closeness in the Kew curves. It is not clear whether Dr. STEWART himself considered that the number of the instances of apparent repetitions and the closeness of the resemblance were such as to demonstrate that more than chance was involved. But provisionally, supposing some definite physical cause to be involved, he suggests that something might lead to the neighbourhood of some particular meridian of the Earth's surface becoming sensitive to radiations received from the Sun, and that the consequence might be the repetition of a special type of disturbance on

\* *Terrestrial Magnetism* (under *Meteorology*), Art. 87.

successive days at about the same hour until the sensitiveness had disappeared. I have seen in the Kew curves a considerable number of instances of the kind referred to by Senor CAPELLO and Dr. STEWART, but in few, if any, has there been so close a resemblance—taking all the elements into account—as that presented by the Antarctic curves of June 28 and June 29, 1903. The interval between the two occurrences, as already stated, was only approximately 24 hours, but in this respect there is no departure from what has been observed of apparent repetitions at Kew and elsewhere. In considering whether more than chance enters into the occurrence regard must be had to the greater or less frequency of the particular type of disturbance, and as to whether it shows a preference for particular hours of the day. It is shown later, p. 189, that this special type of disturbance was in reality of somewhat frequent occurrence in the Midwinter months, and it happened much oftener during the four hours 6–10 p.m. than throughout the remaining 20. Thus the fact that two occurrences should follow one another at nearly a 24-hour interval hardly possesses the significance one is disposed to give it at first sight.

On June 28 the second phase seems to have been hardly completed before the arrival of a second wave-like disturbance of much shorter period. After the passage of this short-period disturbance the V curve comes down the sheet for a time more rapidly than was usual in the special type of disturbance. The disturbance of June 29 was more normal in this respect.

§71. Plate XXX shows another example of the special disturbance occurring on July 26, 1903. The end of the first phase occurred about 5.55 p.m., L.T. In this instance the H trace indicates first an increase, then a decrease, the element being so to speak opposite in phase to the other two, in which the decrease in value comes first. As already stated, this opposition in phase in H sometimes happened, though in but a small minority of cases. The movement in the Antarctic synchronised with the first portions of the disturbance shown in the three lower Christchurch curves of Plate XVII. As Plate XXX shows, there were later disturbances on the same date in the Antarctic, and one or two of the movements show some resemblance to the principal one described above. The V trace throughout its entire length shows a tendency to wave-like swelling forms, and it will be noticed that the hollows in these tend to synchronise more or less closely with peaks on the D and H curves.

The interval between the disturbances of June 29 and July 26 is approximately 26 days 21½ hours, and so is not far from the period 27¼ days which Mr. MAUNDER believes his researches show in magnetic storms at Greenwich. It cannot be said that there is a closer resemblance between the storms of July 26 and June 29 than between those of the former date and the storms of June 28 and June 19. So that the evidence is equally strong for a considerable choice of periods.

§72. Plate XXXI shows another example of the special type of disturbance occurring on August 17, 1903. The end of the first phase was about 7.54 p.m., L.T. The disturbance is not large, but it occurred during a very quiet period. The slowness with which V diminished after attaining its maximum is shown with especial clearness, because the temperature was unusually steady, so that no serious complications arise through it.

§73. Plate XXXII shows a somewhat highly disturbed state of matters in the Antarctic on August 22–23, 1903, synchronising with the disturbances at Christchurch shown in Plate XVIII. The H curve was off the sheet during a considerable portion of the time, first on the one side, then on the other. Probably the range in the element very largely exceeded that shown, 150γ. The D curve went also off the sheet, but only for a short time, a little after 4 p.m., L.T.; the range shown is 3° 45'. Even the V curve shows continual oscillations; the range shown by the trace, 200γ, is only slightly affected by the temperature variation, which was small. There is at least an approach to the special type of disturbance between 3.55 and 4.50 p.m., L.T., but much irregular disturbance existed at the time.

§74. Plates XXXIII and XXXIV show respectively the concluding portion of the trace of August 25–26, 1903, and the commencing portion of the trace of August 26–27. The days intermediate between August 22 and August 25 showed also a good deal of disturbance. During the latter part of August 26 the V magnet was out of action and its trace does not appear in Plate XXXIV. Plates XXXIII and XXXIV cover the time shown by the disturbances at the co-operating stations which appear in Plate XIX. At the co-operating stations the storm had a sudden commencement, consisting of to-and-fro movements—the latter much the larger—occupying from 10.57 to 11.3 p.m., G.M.T., on August 25.

This answers to 10.4 to 10.10 a.m., L.T., on the 26th in the Antarctic. As Plate XXXIII shows, there were also very rapid oscillatory movements in the Antarctic during this time; but there is again some uncertainty about the exact identification of corresponding movements. Conspicuously the most rapid H movement in the Antarctic is the one of which the turning-point is lost owing to the trace going beyond the limits of registration. This consists of a to-and-fro movement, first up, then down the sheet. When the rapid upward movement began the curve was moving up the sheet, but at a comparatively leisurely rate. The time of the rapid acceleration of movement is almost, if not exactly, 10.4 a.m., L.T. Similarly the movement down the sheet continued for some time after a marked reduction appeared in the velocity. The reduction of velocity set in very approximately at 10.10 a.m., L.T. Thus, presumably, the very rapid part of this to-and-fro movement in H—representing a decrease of the element followed by a larger increase—answered to the commencing movement seen elsewhere. At the time when the H trace accelerated its movement up the sheet, the D trace began to move down; but after a minute or two the motion downwards diminished, and a small oscillatory movement intervened of which details are not clearly shown in the original. Thus during the latter part of the very rapid oscillation in H the value of D was nearly stationary. The V trace went through several oscillatory movements. The one which probably corresponds to the double movement in H is that of which the end is represented by a crest which appears nearly 1 mm. to the right of the rapid downward movement in H. The previous turning-point (a hollow) comes between the upward and downward H movements, and answered probably to the turning-point in H which was beyond the limits of registration. The previous turning-point on the V curve is not shown, because the curve was so near the D base line that it got eclipsed by the hour stop, which came on at about 10.3 a.m., L.T. The V double movement is somewhat larger than one which immediately preceded it, but is in no way outstanding.

The most conspicuous movements in Plate XXXIV are those appearing between 6 and 9 p.m., L.T. In particular, there is a bold movement of the D and H curves up the sheet, commencing at 6.45 p.m., L.T. Both curves went beyond the limit of registration, but the turning-point in each was apparently a few minutes after 7.0 p.m., L.T. The return movements down the sheet were equally conspicuous and ended about 7.35 p.m., L.T. This double movement was in all probability of the "special type," but owing to the absence of the V curve our information on the point is incomplete. This movement corresponds in time to that shown by the Christchurch D and V curves in Plate XIX, culminating about 8 a.m., G.M.T., on the 26th. This double movement in the Antarctic was immediately followed by another lasting about 50 minutes, in which, however, the motion of the H magnet was opposite in phase to that of the D magnet. There were large subsidiary oscillations in the H trace. Subsequent to these two large movements there were some rapid oscillations of considerable size during which the D and H traces are a little difficult to distinguish.

§75. Plate XXXV shows the first part of a highly disturbed Antarctic record which commenced a little before 6 p.m., L.T., on October 12, 1903, and ended between 5 and 6 p.m. on October 13. The portion reproduced ends at 4 a.m., L.T., on the 13th. The H trace was beyond the limits of registration continuously from 8 p.m. on the 12th to 8 a.m. on the 13th, whilst the D trace was off the sheet continuously from 4 a.m. to 11.50 a.m. on the 13th. Subsequent to 8 a.m. on the 13th, the H trace came on the sheet at the top, executed a number of oscillations proceeding gradually down the sheet, and disappeared a little after 11 a.m. Subsequent to that, except for a few fugitive appearances, it was not seen until between 3 and 4 p.m. on the 13th. After coming on the bottom of the sheet about 11.55 a.m. on the 13th, the D trace remained on, showing a number of rapid oscillations, until a little after 4 p.m., when it went off the sheet at the top. After remaining off for 10 or 15 minutes it came on again and the disturbance became less.

The range in D shown in Plate XXXV is  $4^{\circ} 36'$ , and that in V 157 $\gamma$ , the latter being practically unaffected by temperature. Between 11.55 a.m. and 4.15 p.m., L.T., on the 13th the range in D exceeded  $4^{\circ} 51'$ . The V trace throughout the whole time covered by the original sheet showed numerous short-period oscillations, but none of the subsequent movements were so large as that shown in Plate XXXV from 9.40 to 10.40 p.m., L.T.

There was a very considerable magnetic disturbance at Kew on October 12–13, but the principal



movements occurred between 6 p.m., G.M.T., on the 12th and 3 a.m., G.M.T., on the 13th (5 a.m. to 2 p.m. on the 13th, Antarctic L.T.). They are thus subsequent to the movements shown in Plate XXXV, and answered to a time when much of the Antarctic trace was beyond the limits of registration. During the time covered by Plate XXXV the range at Kew was 18' in D and 75 $\gamma$  in H, but later, during the two hours 10-12 p.m., G.M.T., on the 12th there was a range of 37' in D and 180 $\gamma$  in H. During a portion of the two hours specified the Antarctic D and H curves were off the sheet simultaneously; the V trace, however, was less disturbed than at various other times.

This is a conspicuous example of the disadvantages attending the use of high sensitiveness in the Antarctic.

§76. Plate XXXVI shows disturbances in the Antarctic on December 13-14, 1903, corresponding to those at the co-operating stations shown in Plates XX and XXI. At the co-operating stations there was a sudden commencement, but it was not very clearly indicated in the H curves at Kew and Falmouth, and its duration in the D curves at these two stations appeared less than in the H curves at Colaba and Mauritius. The Antarctic curves also show a sudden movement, especially that for D. The trace for this element shows a peak at 11.28 p.m., L.T. (0.21 p.m., G.M.T.), followed by a downward movement. During the first two minutes of its occurrence the downward movement is slow, but it suddenly accelerates at 11.30 p.m., L.T., and the movement down the sheet during the next minute represents a rise of 36' in D. This is followed by a less rapid, but larger, movement in the opposite direction, which continued until 11.40 p.m., L.T. (0.33 p.m., G.M.T.), and represented a fall of 77' in D. The second movement, it will be observed, covers the time of the double oscillation seen at Kew and Falmouth. The first movement may possibly be represented by some movements indistinctly shown in the Kew and Falmouth H curves prior to 0.29 p.m., G.M.T.

The Antarctic V trace shows also a distinct double movement, first up, then down the sheet. The summit is distinctly shown at about 11.36 p.m., L.T. (0.29 p.m., G.M.T.). The movements are small, and V was increasing when the first movement set in, thus it is difficult to assign an exact time for its commencement; it occupied apparently not more than one or two minutes, and was most likely synchronous with the rapid part of the commencing D movement. The second, or decreasing, movement in V lasted four or five minutes. It was about 18 $\gamma$  and about double the first movement.

Plate XXXVI consists, it will be noticed, of two portions, separated by an interval of about 3½ hours. During this interval the D and H traces were both continuously beyond the limits of registration. The H trace was, in fact, beyond the limits from 11 p.m., L.T., on the 13th until 9.30 a.m. on the 14th. The mode of its reappearance, as shown in the end or right-hand portion of the plate, is such as to suggest that the limit of registration answering to low values of the element was very much exceeded. The limit answering to high values was also exceeded between 10 and 11 a.m., but only for about 12 minutes.

The left-hand portion of the plate shows D executing considerable oscillations, with a general drift down the sheet after midnight until 5 a.m., L.T., when the limit of registration was exceeded for a few minutes. The total range during these five hours was 4° 12'. The right-hand portion of the plate shows the D trace reappearing after three hours' absence, and then alternately on and off the sheet until 10.30 a.m., L.T., when a very rapid movement up the sheet (diminution of the element) took place. The complete width of the sheet, answering to 4° 52', was crossed in about 18 minutes.

The final portion of Plate XXXVI answers to the end of the Antarctic sheet of December 13-14. The following Antarctic sheet (not reproduced) shows further large disturbances lasting until about 6 p.m., L.T., on the 14th. The most notable V change occurred during the afternoon of the 14th. It consisted of a rise of about 240 $\gamma$  between 1.10 and 1.50 p.m., L.T. D increased 4° 8' between 1.5 and 3.5 p.m., L.T., and then diminished 3° 57' between 3.5 and 5.15 p.m., L.T. A rough estimate of the sum of the D movements, taken irrespective of sign, which were recorded between 10.30 a.m. and 5.15 p.m., L.T., on December 14, proved to amount to no less than 25°.

On October 31 and the early morning of November 1, 1903, there occurred the largest magnetic storm recorded at Kew during several years, but of this no record was obtained in the Antarctic, as the magnetographs were not in action on October 31, nor on the subsequent day until the late afternoon.

§77. The seven Plates XXXVII to XLIII contain copies of portions of a number of Antarctic curves

selected as representing various types of disturbance. They were first drawn by hand on tracing paper and then photographed. The disturbances included in any one of these plates have at least a general similarity of type. One or two hours (*local* time) are marked on the base lines. The curves are shown natural size, so that 20 mm. of abscissa represents very nearly an hour. The principal object being to illustrate the *types* of disturbances, numerical magnitudes were of minor importance, and scale values are thus not shown, to avoid complicating the figures. One could hardly have shown the scale values clearly without greatly extending the area of the plates. If, however, scale values are desired they can be obtained by reference to Table I, and they can be derived approximately from the information given as to the ranges of the elements. The range recorded (D in minutes of arc, H and V in terms of  $1\gamma$ ) refers, in all cases, to the portion of the disturbance actually shown.

§78. Plate XXXVII contains examples of the special type of disturbance which is dealt with in detail in Chapter X, and some closely allied forms. The curve of May 22, 1903, represents a simple example of the normal kind. Shortly before 8 p.m. the D and H curves start running up the sheet (*i.e.* elements both diminish), the V trace being nearly straight, but with a slight tendency downwards (V diminishing). This constitutes the first phase. Superposed on the general drift in the D and H curves are minor oscillations. These render it difficult to say, to the minute, when the turning-point was reached; but all the elements show one within a few minutes after 8 p.m. The second phase then begins. The D and H traces come down the sheet (elements increase) at a rate very similar to that of the first phase. V goes up the sheet (element increases) to a maximum, the rise being considerably in excess of the previous fall. This concludes the second phase, at the end of which H has practically returned to its original value, while V retains an enhanced value for some time, no conspicuous fall setting in until half an hour after the maximum was reached.

On August 31, 1902, we have again a disturbance of the special type, but the fall in V during the first phase is unusually large, and the turning-point in the D curve appears delayed. The end of the special type of disturbance may be put at about 9.20 p.m., when the lowest point appears on the H curve (maximum of force). Thereafter the H curve rises sharply again, and the V curve comes down the sheet, a second wave, as it were, rolling in. After the first 20 minutes of this second wave the H curve hesitates and fluctuates, indicating presumably the action of some independent source of disturbance. This, though able only to check the H movement, sufficed to alter the direction of the D movement, which seemed at first to be about to follow the H. Thus we do not get a repetition of the special type of disturbance.

The limit of registration of the H curve was exceeded—though apparently only very slightly—just before 9 p.m.; the range recorded is measured from this limit. As previously explained, the light was really cut off through the D instrument coming in the way.

Unlike the two other disturbances, that of August 15, 1903, is an early morning one. There are a succession of waves, crests of D and H (*i.e.* minima of force) answering, at least approximately, to troughs (minima of force) in the V curve. The movements in V and D represent nearly equal force components, each fully double the visible change in H. Judging, however, by the appearance of the H trace, the limit of registration was a good deal exceeded. Towards 2 a.m. a final wave will be noticed, which at least approached the special type of disturbance.

§79. Plate XXXVIII shows some transitional forms having a greater or less resemblance to the special type. The disturbance of June 4, 1903, is essentially of this type. H, it is true, is opposite in phase to D, but that happened in an appreciable minority of cases. There were clearly, however, subsidiary disturbances, V showing a succession of small oscillations after the maximum was reached. Owing to subsidiary oscillations, the crest of the D wave is not very clearly indicated, and no assistance in fixing the turning-point is derivable from the H curve, as the trace was off the sheet for fully an hour.

October 4–5 and October 11–12, 1902, are examples of midnight disturbances. In both, the H movement is at least strongly suggestive of the special type. The V magnet, however, was out of action, so that no corroboration is forthcoming from its trace. The D curve is of a somewhat different type. There is at least a suggestion of waves, but they seem of a shorter period than those in H. On both days the D and H curves appear opposite in phase when the large movement in H begins, but towards the end of the interval they seem nearly in the same phase.

§80. Plate XXXIX deals with two occasions in September, 1902, separated by 12 days, when the H trace shows in immediate succession two well-marked oscillations of similar amplitude. On September 6-7 there are four well-marked crests in the H curve, but the first and the last of the oscillations are much smaller than the intermediate two. On this day there are also well-marked waves in the V curve, troughs (minima) answering to crests (minima) in the H curve. The D curve on this occasion is also of a distinctly undulatory type, but its phase seems on the whole a little in advance of that of the H curve.

On September 18-19, 1902, the V magnet was out of action. The D curve, though exhibiting a tendency to wave-like formation, is rather complex.

Both these occasions relate to hours near midnight, when the special type of disturbance tended to assume the more sharply oscillatory character usually associated with the morning hours.

§81. Plate XL shows four examples of early-morning disturbances. On June 21-22 and July 9, 1902, the movements in the V curve are still of a comparatively simple type. On the former occasion we have long wave-like movements in V, but towards 0.30 a.m. minor oscillations are distinctly visible. The H movement in this case, though not quite symmetrical, closely resembles the special type; it represents—what was unusual—a considerably larger component of disturbing force than either the D or the V movements.

On July 9, 1902, the H range is again decidedly the largest. The disturbance on this day on the whole resembles the special type, but a second wave has apparently rolled in before the first was exhausted, so that the V trace appears double-headed. On the whole, the D and H traces are opposite in phase to one another.

January 10, 1903, and December 10, 1902, are examples of large disturbances. On January 10, 1903, the H trace was beyond the limits of registration during the whole interval represented, and even the D trace was off the sheet for a time. The range of D measured to the edge of the sheet was almost  $4^\circ$ , and the time from the minimum to the maximum shown was only 12 minutes. The corresponding change in force is about  $450\gamma$ . The V trace, though showing minor oscillations, is still of a rounded wave-like form, with crests (maxima) answering to troughs (minima) in D. The next two days, January 11 and 12, 1903, it may be remarked in passing, exhibited movements of similar magnitude to those shown on January 10 throughout the same morning hours.

On December 10, 1902, the D trace was beyond—though apparently very little beyond—the lower edge of the sheet from 5.7 to 5.8 a.m., and it just reached the other edge at 6.3 a.m. The most rapid changes were from 4.22 to 4.36 a.m., when D increased  $3^\circ 33'$  in 14 minutes, and from 5.8 to 5.26 a.m., when it fell  $3^\circ 57'$  in 18 minutes. In this instance there are numerous oscillations on the V trace, but, on the whole, it is clear that crests (maxima) on it answer to troughs (minima) on the D curve. The H trace was beyond the limits of registration all the time.

§82. Plate XLI also illustrates morning disturbances. Only the H and V curves are shown, the D trace being largely off the sheet and highly oscillatory. All three examples exhibit numerous oscillatory movements, mostly very irregular. On February 8, 1903, the H curve, however, shows a marked tendency to form sharp-peaked waves, the time of the combined up-and-down movements in each occupying about 25 minutes. On the whole, crests (minima) in H seem to answer to crests (maxima) in V.

Even on February 10 and March 6, 1903, though there are numerous short-period oscillations, the movements in the H curve suggest as a substratum a comparatively regular wave motion of longer period.

§83. Plate XLII contains examples of very sharp oscillations of considerable size. The disturbances on February 25 and 26, 1903, were recorded in the early afternoon; the others in the forenoon. Of the five examples that from April 1 is the most striking. On that occasion the three elements all exhibit one conspicuously large and rapid to-and-fro movement just after 9 a.m.

Within from 6 to 7 minutes D first diminishes  $84'$  and then increases  $70'$ , H falls and rises  $90\gamma$  and V falls and rises  $100\gamma$ . The turning-points for the three elements appear to be really identical in time.

Individually considered, the two specimens from June 10, 1903, are much less striking, but it is a little remarkable that two movements so similar in type and in magnitude should occur within an interval of five hours.

§84. Plate XLIII contains examples of morning disturbances. There are here no longer rounded wave-

like movements, possessing the regularity and considerable period of the special type of disturbance, but instead a constant succession of short-period oscillations or ripples in all three elements. The movements are so large, and the intervals between turning-points so short, that it is hardly possible to decide the exact relationship of the changes in the three elements. Judged by the ranges recorded, the disturbances are not very large; but this merely affords an illustration of how unsatisfactory a criterion of disturbance range alone may be. Thus, on August 15, 1903, during the  $2\frac{1}{2}$  hours considered, the D range was only  $2^{\circ} 9'$ ; but at least 80 turning-points can be recognised on the curve, and the aggregate of the changes in D, taken irrespective of sign, is about  $12\frac{1}{2}^{\circ}$ .

Rapid as the oscillations are in the curves of Plate XLIII, they are, of course, infinitely slow compared to the magnetic changes that accompany the sudden creation or stoppage of an electric current under normal conditions. If they represent the waxing and waning, or the change in distance and direction of electric currents, these changes must presumably present nothing approaching to a discontinuity, in the mathematical sense.

It should be explained that there is no reason to suppose that the magnets under these rapid oscillations behaved in any but the most dead-beat way. There is no suggestion in the curves of vibrations possessing their period.

## CHAPTER IX.

## DISCUSSION OF DISTURBANCES.

§85. In discussing the magnetic disturbances recorded in the Antarctic and the co-operating stations it is desirable to pay some regard to existing knowledge and theories. It has long been known that large magnetic disturbances are usually felt over at least a large portion of the Earth's surface. In a considerable number of instances large storms have been ushered in by comparatively sudden changes in the magnetic elements, which the researches of ADAMS, ELLIS, VAN BEMMELLEN, and others have shown to be in all probability simultaneous in their incidence wherever recorded. It has been observed that magnetic storms are more numerous near sun-spot maximum than near sun-spot minimum, and many persons have suspected a very intimate connection between the two phenomena. In temperate latitudes a display of aurora is practically always accompanied by a magnetic storm, and another invariable accompaniment of the larger and more rapid magnetic changes is the existence of earth currents.

Turning to theories, a considerable number have been advanced. It has been supposed that the Sun is a powerful magnet, and that the regular diurnal variation of terrestrial magnetism and the irregular changes arise from the direct magnetic action of the Sun acting, as we may say, at a distance. Another hypothesis is, that electric waves or Röntgen rays, arising in the Sun, travel to the Earth, and on their arrival set up aurora and magnetic disturbances. Others have postulated the existence of negatively-charged particles (ARRHENIUS), or kathode rays (BIRKELAND), or some analogous form of ray discharge (MAUNDER). The discharge, whatever its nature, on reaching the Earth's atmosphere, occasions electric phenomena which create variations in the Earth's magnetic field. ARRHENIUS has calculated that his hypothetical negative particles will travel from the Sun to the Earth in about 45 hours. BIRKELAND has produced artificially, in the neighbourhood of a small magnetic sphere, or terella, in a high vacuum, electric discharges bearing a close resemblance to various types of aurora, and has attempted to establish a direct connection between individual auroras and the magnetic disturbances recorded during them. Adopting BIRKELAND'S hypothesis of kathode rays, STÖRMER has carried out elaborate mathematical calculations as to the paths of these rays within the Earth's magnetic field, and has concluded that they can approach the surface only in the regions surrounding the magnetic Poles. Mr. MAUNDER has not attempted to assign any exact physical properties to the discharge which he postulates, beyond supposing that it emanates from a sun-spot, and travels out not in all directions but in a compact mass, like a water jet from a hose. The commencement of a magnetic storm answers to the Earth commencing to cross the jet, and the storm continues until the transit of the jet has been accomplished. Supposing the sun-spot to continue active for a time in excess of one complete revolution of the Sun, the Earth will naturally cross the jet again after an interval of about  $27\frac{1}{4}$  days, and a second magnetic storm will be experienced.

If magnetic storms are due to electric carriers or ions of any type, the incidence of the magnetic storm will depend on the Earth's magnetic field, and until the properties of the ions are known the laws governing the intensity of disturbances at different parts of the Earth's surface cannot be inferred. If the carriers are kathode rays, then, assuming STÖRMER'S calculations correct, magnetic disturbances would seem to be necessarily always greater near the magnetic Poles than towards the magnetic Equator, but further than this we cannot apparently go at present.

§86. Direct magnetic action from the Sun was considered long ago by KELVIN, who made a rough calculation of the amount of energy which on this hypothesis would be expended during a large magnetic storm. The result which he reached seemed to KELVIN inadmissably large. Physicists' ideas, however, as to solar energy have considerably altered of late, and I think it will be generally allowed that in our present state of knowledge it is safest to admit the possibility of expenditures of energy which 20 years ago would have appeared incredible. It must also be allowed that, whilst physical speculators in the past do not seem to have been deterred by the absence of outward and visible signs of magnetism in the Sun, still the discovery by Professor HALE of the Zeeman effect in light received from sun-spot areas affords a direct evidence which has hitherto been lacking. Dr. SCHUSTER, it is true, has already discounted Professor HALE'S discovery to some extent, by publishing in 'Nature' an estimate of the

possible size of the effect on the Earth of the largest of sun-spot areas, endowed with what he considers the largest magnetic moment reasonably attributable. The resulting disturbance is only of the order of  $\frac{1}{10000}$  of the range of large magnetic storms at Greenwich, and Dr. SCHUSTER thus reaches much the same conclusion as Lord KELVIN. Just, however, as in KELVIN's case, I think it would be unwise at present to pass a final judgment. It must also be remembered that magnetic disturbances are of varied forms and sizes. Even if we were justified in concluding that large movements—of, say, 1000 $\gamma$ —in H cannot be due to direct magnetic action from the Sun, it is still conceivable that the comparatively small but outstanding movements which often precede by several hours the largest movements of a disturbance may represent such direct action. I have, thus thought it worth while to make a few mathematical calculations as to what might be expected to happen if direct action took place. The Sun's distance being so great compared to the Earth's diameter, the field due to the Sun's action at any instant may be treated as constant throughout an element of space large enough to contain the Earth and her atmosphere. The presence of the Earth modifies the field, and thus leads to variations in the disturbing force experienced at different parts of her surface. The problem is not strictly a statical one, as the disturbing forces do not remain constant. Rapid, however, as magnetic changes may seem when recorded by ordinary slow-running magnetographs, they are usually infinitely slow as compared to the changes which occur in wireless telegraphy. Even the sudden commencements of storms, as we have seen, consist of changes persistent in one direction for several minutes, the rate of change being usually less than 10 $\gamma$  per minute. There is thus reason to think that whilst the treatment of the problem as a statical one involves departures from actual conditions, the results ought not to suffer so much from this limitation as to be unworthy of consideration. A complete treatment ought of course to regard the Earth as a conductor of electricity. Earth currents, we know, have diurnal, annual and irregular variations, and there can be no doubt that a relationship exists between these currents and the phenomena of terrestrial magnetism. Our knowledge at present, however, as regards Earth currents, is exceedingly limited. Even close to the surface but few reliable observations have been made, and what depths the currents may extend to, or what the electrical resistance of the several strata is, we do not know. The fact that the greater portion of the Earth's surface is sea may be a most important consideration. We are thus almost perforce obliged to confine ourselves to the statical problem, which will now be considered.

§87. It must be admitted that our direct knowledge of the Earth's magnetic quality is very slight. There are few surface materials which are appreciably magnetic, and how the Earth comes to be a magnet is a mystery. A magnet however it must be unless there is something absolutely wrong in the application of the Gaussian analysis. According to that analysis, the source of the Earth's magnetism is almost entirely internal, and the potential, to a rough first approximation, is that due to a solid sphere or internal spherical shell uniformly magnetised. The natural inference is that the Earth's magnetic quality is, to a first approximation, a function only of the distance  $r$  from the centre. We shall first consider the simplest case, viz., that of a sphere of uniform permeability  $\mu$  and radius  $a$ . Let  $F$  denote the strength of the field in the absence of the sphere, and let  $r$  and  $\theta$  be polar co-ordinates,  $\theta$  being measured from the diameter which coincides with the direction of the field  $F$ . On the introduction of the sphere the field in the medium outside it, supposed of unit permeability, is given by

$$V = -Fr \cos \theta + \frac{\mu - 1}{\mu + 2} F \frac{a^3}{r^2} \cos \theta \dots \dots \dots (1).$$

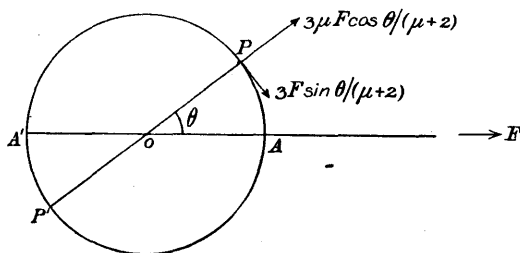

In the figure, APA' is a section through the centre O of the sphere, A'A being the diameter parallel to the direction of the field F.

The force at any point P ( $a, \theta$ ) just outside the sphere may be regarded as composed of a normal (*i.e.* vertical) component  $3\mu F \cos \theta/(\mu + 2)$ , and a tangential (*i.e.* horizontal) component  $3F \sin \theta/(\mu + 2)$ .

If  $\psi$  be the inclination to OA of the resultant force R at P, then

$$\tan \psi = (\mu - 1) \sin 2\theta \div \{(\mu + 1) + (\mu - 1) \cos 2\theta\} \dots \dots \dots (2),$$

$$R/F = 3(\mu + 2)^{-1} \{\mu^2 - (\mu^2 - 1) \sin^2 \theta\}^{1/2} = 3(\mu + 2)^{-1} \{1 + (\mu^2 - 1) \cos^2 \theta\}^{1/2} \dots \dots \dots (3).$$

If  $\mu - 1$  be small, then  $\psi$  is small and R/F differs but little from unity, as of course is obvious *a priori*.

Over the surface, R obviously has its maximum value when  $\theta = 0$ , its minimum when  $\theta = \pi/2$ , and

$$\left. \begin{aligned} R_{\max.}/F &= 3\mu/(\mu + 2), \\ R_{\min.}/F &= 3/(\mu + 2) \end{aligned} \right\} \dots \dots \dots (4).$$

Thus

$$R_{\max.}/R_{\min.} = \mu \dots \dots \dots (5).$$

The maximum occurs at the ends of the diameter  $\theta = 0$ , where the force is entirely vertical, the minimum at all points on the perpendicular great circle, where the force is entirely horizontal.

Clearly the phenomena will depend mainly on whether  $\mu$  is large. If it were possible to suppose  $\mu$  large, we should have a wide range of values of R, and the disturbing forces—regarding F as a disturbing field—would vary widely in direction at different parts of the surface. But it is difficult to suppose that  $\mu$  is large. The Earth's own field is only of the order 0.5 C.G.S. units, and a disturbance as large as 0.01 C.G.S. is exceptional. Even in the best magnetic steel  $\mu$  is low for such fields. Apart from more theoretical considerations there is the fact that, according to the above solution, if  $\mu$  were large, the horizontal (or tangential) component  $3F \sin \theta/(\mu + 2)$  would tend to be negligible compared to the vertical  $3\mu F \cos \theta/(\mu + 2)$ , except at places where  $\theta$  is nearly  $\pi/2$ . Now the tendency is not for the horizontal component of disturbances to be small compared to the vertical, but rather the opposite.

A point calling for special remark is that R has the same value and the same absolute direction in space for places on the same great circle through AA' whose angular co-ordinates are  $\theta$  and  $\pi + \theta$ ; in other words, the disturbing forces are equal and parallel at any two places diametrically situated with respect to one another.

§88. As the Earth's crust is on the whole non-magnetic, the above simple problem is obviously an imperfect representation of the facts. Thus it is worth glancing at the next simplest case, that presented by an earth composed of a nucleus of radius  $a$  and permeability  $\mu$ , with a surrounding shell of permeability  $\mu'$  and radius  $a'$ , the medium external to  $a'$  having unit permeability. The imposed field being F as before, I find for the potential external to the "earth"

$$V = -Fr \cos \theta + F \frac{a^3}{r^2} \cos \theta \frac{(\mu + 2\mu')(\mu' - 1) + (\mu - \mu')(2\mu' + 1)(a/a')^3}{(\mu + 2\mu')(\mu' + 2) + 2(\mu - \mu')(\mu' - 1)(a/a')^3} \dots \dots (6).$$

In practice the only interesting case seems that in which  $\mu' - 1$  is small, *i.e.* in which the material of the layer is only slightly magnetic. In this case, assuming  $a/a'$  not to be very small, the potential is approximately given by

$$V = -Fr \cos \theta + \frac{\mu - 1}{\mu + 2} F \frac{a^3}{r^2} \cos \theta \dots \dots \dots (7).$$

This is identical in form with (1), the only difference being that in (1)  $a$  represents the radius of the "earth," whilst in (7) it represents the radius of the magnetic nucleus. If the slightly magnetic crust be thin, the phenomena are much the same as if the permeability were  $\mu$  throughout. If the thickness of the crust be considerable, the variation in R over the surface is considerably reduced. Whether the crust be thick or thin, the value and the direction of R are the same at diametral points.

In this investigation the only assumption made as to the disturbing field F is that it may be regarded as uniform so far as the Earth is concerned. Thus it need not be due to the Sun, but might represent any stray field that happens to exist in any part of space traversed by the Earth, so long, of course, as the hypothesis of uniformity in strength and direction is approximately satisfied. Some of the phenomena

of terrestrial magnetism are a little suggestive of the existence of such fields, and it is well to bear the possibility of their existence in mind.

§89. The elements which are usually recorded by magnetographs are the Vertical Force, the Horizontal Force, and the Declination. By an increase in Vertical Force is meant a force  $\Delta V$  tending to pull towards the Earth's centre the dipping pole of the magnet. A + sign to  $\Delta V$  thus denotes a force urging the N-pole of a magnet towards the Earth's centre when the N-pole is, as at Kew, Falmouth, and Colaba, a dipping pole. But at Mauritius, Christchurch, and Winter Quarters, a + sign attached to  $\Delta V$  means a force urging the N-pole from the Earth's centre. An increase  $\Delta H$  in the Horizontal Force means a force urging the N-pole in the direction of the magnetic Meridian drawn towards the magnetic Pole in the northern hemisphere. An increase  $\Delta D$  in the Declination means a force  $H \Delta D$  urging the N-pole perpendicular to the magnetic Meridian, in the direction of  $D$  increasing. At Kew  $\Delta H$  when of + sign means a force on a N-pole inclined at  $16\frac{3}{4}^\circ$  to the west of geographical north, while  $\Delta D$  when of + sign means a force on a N-pole (tending to increase westerly Declination) inclined at  $16\frac{3}{4}^\circ$  to the south of geographical west. At Colaba, where the Declination is easterly but nearly zero,  $\Delta D$  when + means a force acting nearly due east. At Christchurch, where Declination is about  $16\frac{1}{3}^\circ$  east,  $\Delta D$  when positive means a force  $H \Delta D$  inclined at about  $16\frac{1}{3}^\circ$  to the south of geographical east.

Thus, even as related to the local geographical directions, increments in  $D$ ,  $H$ , and  $V$  have at the different stations widely different significance. As referred to fixed axes in space, the significance is even more complex. Christchurch and Falmouth, for instance, differ nearly  $180^\circ$  in longitude, so that what is east at the one is west at the other.

The above considerations will show that in studying disturbances it is desirable not to confine our attention exclusively to the disturbances  $\Delta D$ ,  $\Delta H$ , and  $\Delta V$ , but to take account also of the disturbances  $\Delta N$  and  $\Delta E$  to geographical north and east, and, finally, to regard the disturbance at any place as a vector possessed of magnitude and having directions referred to three fixed axes at the Earth's centre.

For co-ordinate axes let us take the Earth's axis as axis of  $z$ , a perpendicular axis in the Meridian of Greenwich as that of  $y$ , and a second perpendicular axis in the Meridian  $90^\circ$  east of Greenwich as axis of  $x$ . Let  $\Delta D$ ,  $\Delta H$ ,  $\Delta V$  denote the disturbing forces experienced at a place of latitude  $\lambda$  and (easterly) longitude  $l$ , assuming  $\Delta D$  to be counted positively when easterly Declination increases, and  $\Delta V$  to be counted positively when it urges a N-pole towards the Earth's centre. (We are here departing, it should be noticed, somewhat from the common usage.) Then for the corresponding components  $\Delta X$ ,  $\Delta Y$ ,  $\Delta Z$  relative to the system of co-ordinates specified above, I find

$$\left. \begin{aligned} \Delta X &= H \Delta D (\cos l \cos D + \sin l \sin D \sin \lambda) + \Delta H (\cos l \sin D - \sin l \cos D \sin \lambda) - \sin l \cos \lambda \Delta V, \\ \Delta Y &= H \Delta D (-\sin l \cos D + \cos l \sin D \sin \lambda) + \Delta H (-\sin l \sin D - \cos l \cos D \sin \lambda) - \cos l \cos \lambda \Delta V, \\ \Delta Z &= -H \Delta D \cos \lambda \sin D + \Delta H \cos \lambda \cos D - \Delta V \sin \lambda \end{aligned} \right\} (8).$$

The geographical co-ordinates of the several stations and the mean value of  $D$  for the epoch 1902-3 are given in the following table:—

Station.	Latitude.	Longitude.	Declination.
	° /	° /	° /
Kew . . . . .	51 28 N.	0 19 W.	16 43 W.
Falmouth . . . . .	50 9 N.	5 5 W.	18 20 W.
Colaba . . . . .	18 54 N.	72 49 E.	0 18 E.
Mauritius . . . . .	20 6 S.	57 33 E.	9 16 W.
Christchurch . . . . .	43 32 S.	172 37 E.	16 18 E.
Antarctic . . . . .	77 51 S.	166 45 E.	152 40 E.

In the formula,  $D$  is to be regarded as positive when Declination is easterly as at Christchurch, and  $\lambda$  as positive when latitude is northerly as at Kew. Where the S-pole dips,  $\Delta V$  is to be regarded as negative when the numerical value of  $V$  increases.



For illustration, take the case where numerical increases of  $1'$  in  $D$  and of  $10\gamma$  in  $H$  and in  $V$  occur at each of the two stations Kew and Christchurch. We have for 1902-3 :—

	At Kew.	At Christchurch.
$\lambda$	+ 51° 28'	- 43° 32'
$l$	359° 41'	172° 37'
$D$	- 16° 43'	+ 16° 18'
$\Delta D$	- 1'	+ 1'
$H$	.185	.227
$\Delta H$	+ 10 $\gamma$	+ 10 $\gamma$
$\Delta V$	+ 10 $\gamma$	- 10 $\gamma$
$H \Delta D$	- 5.4 $\gamma$	+ 6.5 $\gamma$

As a matter of fact, in the calculations I took the Meridian of Kew, not that of Greenwich, as the  $yz$  plane, measuring  $l$  from it, but to the degree of accuracy aimed at that is immaterial.

If one desired to obtain the components along the fundamental  $x, y, z$  axes of the components of the disturbing force  $\Delta N$  and  $\Delta E$  towards geographical north and east respectively, this would be readily effected by supposing  $D = 0$  in the formulæ, and writing  $\Delta N$  for  $\Delta H$  and  $\Delta E$  for  $H \Delta D$ .

§90. A question calling for some consideration is: what is to be regarded as a disturbance, and how is its magnitude and direction to be determined? SABINE, whose work on Terrestrial Magnetism still commands respect, regarded the value of an element at any particular instant as disturbed when it departed from the mean value of the element at that time of day—contributions from disturbed days having been removed—by more than a specified limiting value. This regards the departure from an undisturbed mean value as the measure of a disturbance. The difficulty, of course, is to arrive at the undisturbed mean value. SABINE'S method, theoretically considered, was to do this by a process of sifting, rejecting first such individual values as departed notably from the mean derived from all, then forming a new mean from the individual values retained and repeating the process, and so on.

In practice the method would be very laborious if strictly followed. A serious difficulty is that the amplitude, and sometimes the type, of the regular diurnal inequality varies largely throughout the year, and that there is a large sun-spot influence on the amplitude at least, if not on the type.

From the point of view of SABINE'S definition, the natural thing would be to take  $\Delta D$ ,  $\Delta H$ , and  $\Delta V$  as given at any instant by the departures of  $D$ ,  $H$ , and  $V$  respectively from mean undisturbed values appropriate to the hour. But to make even the pretence of doing this satisfactorily it would be necessary to have a knowledge of what might reasonably be regarded as normal or undisturbed values. To obtain such normal values for the Antarctic seemed wholly impracticable, and to have obtained them even for the co-operating stations would have required regular diurnal inequalities to have been formed appropriate for the several months of the years 1902 and 1903. One could, of course, have derived diurnal inequalities from the hourly observations on the international term days, but two days a month afford a very slender basis for diurnal inequalities.

In the case of the larger Antarctic disturbances comparatively little could be done, because one at least of the traces was pretty sure to be off the sheet, and even if all three traces happened to be on, the oscillatory movements were so large and rapid that it was difficult to assign the times with sufficient accuracy. Most of the measurements that proved practicable referred to disturbances of the special type dealt with in Chapter X.

On considering the situation, I decided that the most hopeful course to pursue was to focus attention on *changes* in the values of the magnetic elements occurring during comparatively short intervals, especially on the commencing movements introducing magnetic storms. In dealing with changes of short duration we are comparatively independent of anything but disturbance pure and simple, especially when the changes occur at hours when the regular diurnal changes are slow, or at seasons when the regular diurnal changes are small. This seems to be practically the same conclusion as that reached many years ago by Dr. BALFOUR STEWART, when he gave his attention to what he called "peaks" and "hollows" in the magnetic curves, *i.e.* turning-points separated by no long interval of time.

To give greater definiteness, take the most favourable case where three consecutive turning-points present themselves simultaneously in the D, H, and V records. Suppose the 1st and 3rd to represent minima, the 2nd a maximum, and suppose the values of the elements answering to the two minima to be identical.

Let  $t_1, t_2, t_3$  be the times of the three turning-points, and let  $\Delta D, \Delta H,$  and  $\Delta V$  represent the excess of the values of D, H, and V at time  $t_2$  over the values at time  $t_1$  or at time  $t_3$ .

If we take the condition of matters existing at time  $t_1$  as fundamental, we may regard the condition existing at time  $t_2$  as arising from the action of a disturbing force  $\Delta R$ , whose components  $\Delta X, \Delta Y, \Delta Z$  are obtained from (8) by assigning to  $\Delta D, \Delta H,$  and  $\Delta V$  their values with positive sign. If, however, we take the condition at time  $t_2$  as fundamental, we regard the condition at time  $t_3$  as due to a disturbing force  $\Delta R'$ , whose components are obtained from (8) by assigning the same numerical values to  $\Delta D, \Delta H,$  and  $\Delta V$ , but giving them the negative sign. The vectors  $\Delta R$  and  $\Delta R'$ —assuming the changes  $\Delta D, \Delta H, \Delta V$  to be small—are numerically equal, but are oppositely directed. Presumably  $\Delta R$  and  $\Delta R'$  really represent, the one the application of a force, the other its removal. The difficulty in practice is to know which is which. As a rule, when an oscillatory movement occurs, the to-and-fro movements are not equal, and there are usually both preceding and succeeding movements. Even if we take the sudden movements ushering in storms there is room for some doubt. At Kew, for instance, when such a movement occurs, H is usually found to be enhanced after the first rapid change has ceased, but at the very commencement of the movement there is at least sometimes a slight depression in the value. If no preliminary depression is seen, it is certainly the natural thing to regard the disturbance as simply an increase in H, but still there is the possibility that the rise represents in reality the removal of a disturbing force which has remained nearly constant for a considerable time. We are much in the same position as an observer who sees the length of a bar under test, but does not know whether it is loaded or unloaded, nor whether the load is a tension or a compression.

§91. An investigation was made of the disturbed curves received from the co-operating stations, and when the three elements presented synchronous changes and there appeared an agreement in time between the changes recorded at two or more of the different stations, measurements were made. The algebraical excess of the value of an element at the end of the interval considered over the value at the commencement was regarded as representing the action of a disturbing force. No attempt was made to determine whether the change was really due to the application of a force or to its removal. From the  $\Delta D$  and  $\Delta H$  thus found the values of  $\Delta N$  and  $\Delta E$  (the components to geographical north and east) were calculated, and also the values of  $\Delta X, \Delta Y, \Delta Z$  as given by (8).

The resultant  $\Delta R$  of  $\Delta X, \Delta Y,$  and  $\Delta Z$  was then found, and finally the inclination  $\theta$  of this resultant to the Earth's axis and the easterly longitude  $\phi$  of the meridian plane containing it.

The positive direction of the Earth's axis was taken as given by the radius drawn to the North Pole.  $\theta$  and  $\phi$  are given, of course, by

$$\cos \theta = \Delta Z / \Delta R, \quad \tan \phi = \Delta X / \Delta Y. \quad \dots \dots \dots (9).$$

The most uncertain measurements by far at the co-operating stations were those of  $\Delta V$ . The changes in V were usually small. For 1902 no Falmouth V curves were available, so that there was nothing to check the Kew ones by, and at Colaba the sensitiveness was throughout so small that a small change was hardly visible.

§92. Tables LXII to LXVI at the end of this chapter give the results obtained from the measurement of corresponding movements at Kew, Colaba, Mauritius, Christchurch, and the Antarctic. The occasions dealt with are taken from the storms included in the plates. The times are all G.M.T.

Of the examples for Kew in Table LXII, p. 181, those from August 20, 1902, April 5 and August 25, 1903, refer to sudden commencements of storms. The same is true of the disturbance on May 8, 1902, between 11.59 a.m. and 0.9 p.m. This disturbance is treated as a whole for purposes of comparison with the other co-operating stations, but also as composed of two parts for comparison with the Antarctic, where the commencing movement is pronouncedly double. The rapid commencements were also treated as if the mean derived from them represented a disturbance.

The disturbances of June 19, 28, 29 and July 26, 1903, were simultaneous with the two phases of the special type of disturbance recorded in the Antarctic. In this case also an imaginary mean disturbance has its components calculated, and the resultant and its direction angles thence deduced.

Owing to electric tram disturbances, changes of the order  $0.5\gamma$  in  $V$  could not be recognised with any approach to certainty. This is no doubt partly responsible for the fact that the value 0 is so frequently assigned to  $\Delta V$ . When the vector is small there is inevitably a good deal of uncertainty in the determination of both  $\theta$  and  $\phi$ , and the values given must not be regarded as usually more than somewhat rough approximations to the truth.

On examining the results it will be seen that practically all the disturbances may be regarded as included under one or other of two types, distinguished by the letters A and B. The disturbances of the type A have a value of  $\theta$  in the neighbourhood of  $60^\circ$  and a value of  $\phi$  in the neighbourhood of  $220^\circ$ . They include those sudden commencements in which the increase of  $H$  is the most noticeable feature, and the movements corresponding in time with the second phase of the Antarctic disturbances of the special type. An exception is provided by the disturbance of June 19, 1903, in which the value of  $\phi$  departs largely from  $220^\circ$ . On this occasion, however, the disturbance at Kew was so small that comparatively little weight attaches to the results deduced. The disturbance on May 8, 1902, from 7.4 to 7.11 p.m., is also included amongst the A's. The disturbances to which the letter B is attached have a value of  $\theta$  which is in the neighbourhood of  $120^\circ$ . The values of  $\phi$  are more variable, but are all included between  $+63^\circ$  and  $-63^\circ$ . The movements corresponding in time to the first phase of the special type of Antarctic disturbances all come fairly under this category; so does the first phase of the sudden commencing movement of August 25, 1903.

§93. The disturbances at Colaba, in Table LXIII, p. 182, are also mainly of two types, distinguished as before by the letters A and B. The characteristic feature at Colaba is the large size of  $\Delta Z$ , the component parallel to the Earth's axis, and the small size of  $\Delta X$  and  $\Delta Y$ . Owing to this latter fact the evaluation of  $\phi$  is particularly uncertain, and comparatively little significance can be assigned it. We may thus regard the essential feature of the type A disturbances as the possession of a small value for  $\theta$ , and the essential feature of the type B disturbances as the possession of a value for  $\theta$  approaching  $180^\circ$ .

The sudden commencements in which  $H$  increases, and the disturbance synchronising with the second phase of the Antarctic disturbance of July 26, 1903, are included amongst the A's, and so is the movement between 7.4 and 7.11 p.m. on May 8, 1902. Thus the A's at Colaba and the A's at Kew correspond to one another.

Comparing the values of  $\Delta R$  at Kew and Colaba, it will be seen that the former are very decidedly the larger, except on May 8, 1902.

§94. For the Mauritius Table LXIV, p. 182, our information is less extensive, as the copies of disturbances in D and V were mostly confined to 1902.

As at Kew and Colaba, the sudden commencements of May 8 and August 20, 1902, and the movement from 7.4 to 7.11 p.m. on the former date, are of similar type and are classed as A's. The values obtained from  $\Delta R$  are all smaller than the corresponding values at Kew or Colaba.

§95. The data for Christchurch, Table LXV, p. 182, include all the disturbances already considered for Kew. The results are more difficult of classification than those at the other co-operating stations. The commencing disturbances of May 8 and August 20, 1902, and of April 5, 1903, as well as the movements answering in time to the second phase of the Antarctic disturbances of June 19, June 28, and July 26, have been classed as A's. They present, however, a considerable range of values in  $\theta$  as well as in  $\phi$ . This group also includes the *first* of the to-and-fro movements experienced on August 25, 1903. This last movement was, however, so minute that too much weight should not be ascribed to the fact.

As elsewhere, the movement from 2.10 to 2.28 p.m. on May 8, 1902, and that answering to the first phase on July 26, 1903, appear of similar type and have been classed as B's. But the first movement on July 26 is clearly of the same type as the *second* on June 29, so this also must be classed as a B. The first-phase movements on June 19, June 28, and June 29, 1903, are very similar in type, but differ from either the A or the B class, and have accordingly been classified as C's. This class seems also to include the second and larger movement on August 25, 1903.

If we consider the sudden commencements, we find that the values of  $\Delta R$  at Christchurch are decidedly

less than those at Colaba, and apparently a little less than even those at Mauritius. When, however, we consider the disturbances answering to those of the special type in the Antarctic, it is otherwise.

§96. Table LXVI, p. 183, gives results for the Antarctic corresponding to those given for the co-operating stations. The movements include those treated in Table LXII, except the movement on May 8, 1902, from 7.4 to 7.11 p.m., which was partly lost in the Antarctic, and they include, in addition, the second phase of the commencing movement on April 5, 1903, which was essentially peculiar to the Antarctic. The letter *i* denotes that the Antarctic records were not absolutely complete. On April 5, 1903, the first phase was complete, but in the second phase the H curve went off the sheet. The amplitude shown,  $300\gamma$ , was probably not much exceeded. On June 19 and 28, and July 26, both phases suffered loss. On June 19 the loss was confined to H, and on June 28 to D, but on July 26 both D and H went beyond the limit of registration. In all these cases, so far as one could judge from the appearance of the curves, the major part of the movement was recorded, though on July 26 the loss was probably greater than on the other days. These losses, of course, introduce some uncertainty, and one would naturally have used other examples of the special type of Antarctic disturbance but for the fact that a comparison was desirable with other stations, and that days had thus to be chosen when records from the co-operating stations were available.

To reduce the uncertainty thus arising, a mean disturbance was derived from 51 examples of the special type of disturbance for which the records were complete. The values of  $\Delta D$ ,  $\Delta H$ , and  $\Delta V$  were meaned for the two phases separately, and from the mean  $\Delta D$  and  $\Delta H$  corresponding mean values for  $\Delta N$  and  $\Delta E$  were found. From these and the mean  $\Delta V$  there were calculated corresponding mean values of  $\Delta X$ ,  $\Delta Y$ , and  $\Delta Z$ , and the force vector deduced therefrom. Comparing the results thus found with those obtained by meaning the disturbances of June 19, 28, 29, and July 26, 1903, in like fashion, we see that in the case of the first phase there is a very close agreement in the values of the angles  $\theta$  and  $\phi$ . In the case of the second phase the agreement is not quite so good.

The sudden commencements were also grouped with a view to obtaining representative means. The operation was limited to May 8 and August 20, 1902, and August 25, 1903, these being the only three occasions on which both phases were completely recorded. In this case the phases in which the elements increased were grouped together, irrespective of whether they occurred first or second. The values of  $\theta$  and  $\phi$  obtained for the two phases in this case correspond fairly closely with those obtained for the two phases of the mean representative of the special type of disturbance.

All the examples in Table LXVI can be fairly included in two classes, distinguished as before by the letters A and B. Class B includes all the first phases of the special type of disturbance, and that phase of the sudden commencements during which the element decreased in value. Class A, on the other hand, includes all the second phases of the special type of disturbance, and that phase of the sudden commencements during which the element increased in value. In choosing which letter to apply, the guiding principle was, that at the co-operating stations A represented a type of disturbance in which the element or elements of force chiefly affected during sudden commencements exhibited an increase.

§97. On July 24-25, 1902, there were recorded at Kew a number of oscillatory disturbances of no great magnitude. On examining these I found that the turning-points in the three elements appeared identical in a considerable number of cases, and also that corresponding movements could be traced at the other co-operating stations. Table LXVII, p. 184, deals with the measured changes of force on ten of these occasions, at Kew, Colaba, and Mauritius, and with a minor number of them at Christchurch and the Antarctic. As the afternoon of the 24th (G.M.T.) advanced, it became increasingly difficult to obtain movements that appeared to correspond, the difficulty appearing first in the Antarctic data, and then in the Christchurch ones.

The first four movements consisted, at Kew, of a rise in force from 2.23 to 2.30 p.m., followed by a fall from 2.30 to 2.38 p.m., then another rise from 2.38 to 2.43 p.m., and a second fall from 2.43 to 2.54 p.m. The two double movements appeared of the same type at all the stations; thus, instead of treating them separately I took a mean from the two, combining the two falls together, and the two rises together. These are numbered (1) and (2) in the table, as if the means represented each a single movement. The other cases, (3) to (8), represent actual single changes of force. If we examine the

eight cases, we see that at Kew Nos. (1), (5), and (7) may be regarded as of the Class A of Table LXII, whilst Nos. (2), (3), (4), (6), and (8) are of Class B.

Coming to Colaba we recognise No. (1) as of the Class A of Table LXIII, and Nos. (2), (3), and (4) as of Class B. So far as the angle  $\theta$  is concerned, Nos. (5) and (7) approach Class A, and Nos. (6) and (8) approach Class B, but the  $\phi$  angle differs rather notably from that characteristic of the respective classes.

At Mauritius we can recognise No. (1) as of the Class A of Table LXIV, and Nos. (2), (3), (4), and (8) as of the Class B.

At Christchurch Nos. (1) and (5) are of the Class A of Table LXV, though No. (5) is rather outstanding, and Nos. (2), (3), and (4) are good examples of Class B. After 5.42 p.m., G.M.T., the Christchurch curves seemed to lose their parallelism with those at Kew entirely.

At the Antarctic No. (1) is fairly of the type of Class A of Table LXVI, and No. (2) is fairly of Class B. The turning-points, however, in the Antarctic were not very clearly marked in the H and V curves, and whilst they were clearly marked in the D curve—in which alone the movements stood out from their neighbours—they appeared to be hardly absolutely coincident in time with the movements they were believed to correspond to at Kew.

§98. In the course of our discussion of Tables LXII to LXVII there have been references to the relative size of the corresponding disturbances at different stations. The information on this point is summarised in Table LXVIII, p. 185, which expresses the amplitude of the disturbance  $\Delta R$  at each station in terms of the amplitude of the synchronous disturbance at Kew. In addition to results from individual cases the table gives mean results, treating separately the sudden commencements, the special type of disturbance, and the disturbances which belong to neither of these categories. Considering the comparatively limited data, too much weight must not be attached to numerical resemblances which may be partly accidental.

We have already seen that, so far as type is concerned, sudden commencements do not appear to be in any way essentially different from other short-period movements such as those of July 24, 1902. The similarity seems to extend to the variation in amplitude with geographical position. Taking either of these types of disturbance, the amplitudes at Mauritius and Christchurch are decidedly less than those at Colaba, which in their turn are less than those at Kew and Falmouth. But the movements, even at Kew and Falmouth, are much exceeded by those in the Antarctic, and this seems the case habitually, irrespective of whether the time of occurrence is day or night at Greenwich.

With regard to the relatively small size of sudden movements at Mauritius and Christchurch there is one possible explanation which must be borne in mind. In selecting disturbed days for comparison I had before me only Kew and Antarctic curves, the latter being invariably disturbed. Thus, no doubt, it was the amplitude of the Kew disturbance, or some special feature in it, which mainly determined the choice. It is thus conceivable, if instead of the Kew curves I had had the curves from some station in the southern hemisphere to guide me, that a different selection might have been made, and that under these circumstances there might not have been the pre-eminence in the amplitude of the disturbances at Kew and Colaba as compared to those at Mauritius and Christchurch which the table shows. Some countenance to this view is supplied by the results for the special type of disturbance. Corresponding movements could indeed be traced at Kew, but in no case were they so outstanding as to have caught the eye if merely glancing through the curves generally. In their case it will be seen that the disturbance experienced at Christchurch was usually much larger than that at Kew. If, however, the selected sudden commencements represented magnetic effects whose seat was mainly in the northern hemisphere, the extraordinarily large size of these movements in the Antarctic would be even more remarkable than it appears to be. Thus I do not think that the suggested explanation suffices, though there may be some truth in it.

As regards the special type of disturbance, we must, I think, conclude that though the effects are felt in the northern hemisphere, yet the seat of the disturbance must be mainly at least in the southern hemisphere.

§99. There is one notable peculiarity about the Antarctic results that calls for comment. At Kew, Falmouth, Colaba, Mauritius, and Christchurch the result of a sudden commencing movement, whether single or visibly double, is normally—to leave the total force increased. At Kew the

change is usually greatest in H, though sometimes in D. Taking the H change as the most notable, we can usually see with certainty only an increase, but sometimes a smaller decrease for a relatively short time is distinctly visible, and on other occasions, though not clearly visible, it is suggested by the appearance of the curve. In the Antarctic there were six occasions—May 8, August 20, and November 6, 1902; and April 5, August 25, and December 13, 1903 (Greenwich dates)—when sudden movements were detected synchronous in time with sudden commencements at Kew and elsewhere. All these six were distinctly double or oscillatory movements, and in all the second movement was the larger. So far there is no certain difference from the phenomena at Kew, as we are not in a position to say with certainty that when only one movement was seen at Kew it was unaccompanied by a previous very small and short-lived diminution in H. But of the six Antarctic double movements, three had the first movement a decrease in the elements, while three had it an increase. The three occasions which showed the increase first were May 8 and November 6, 1902, and December 13, 1903.

On May 8, 1902, we have an Antarctic disturbance A followed by a larger disturbance B, the two synchronous with a Kew disturbance A. On August 20, 1902, we have an Antarctic B disturbance, unrepresented elsewhere, followed by an A disturbance which synchronised with an A disturbance at Kew. On November 6, 1902, we have an Antarctic A disturbance synchronising with a Kew B disturbance, and then an Antarctic B disturbance synchronising with a Kew A disturbance. On April 5, 1903, we have an Antarctic B disturbance synchronising with a Kew A disturbance, being followed by a larger A disturbance not represented at Kew. On August 25, 1903, we have an Antarctic B disturbance synchronising with a Kew B disturbance, there immediately following a larger A disturbance at both stations. On December 13, 1903, we have an Antarctic A disturbance not apparently represented elsewhere, followed by a B disturbance which covered the time occupied by a B and A disturbance at Kew, the latter the larger.

All of the special disturbances present the B type first in the Antarctic, and this is true in three of the four cases at Kew. Between 2.10 and 2.28 p.m., G.M.T., on May 8, 1902, we have a B disturbance at Kew, but an A disturbance in the Antarctic. On July 24, 1902, the A and the B disturbances at the two stations correspond.

It would thus appear that whilst A and B movements in the Antarctic are just as opposed to one another in type as they are elsewhere—the one representing an increase, the other a decrease in the elements which vary most—the order in which they occur shows a variability which is at least unusual, and either may synchronise with an A movement at the co-operating stations.

§100. The subject of the coincidence in time of the commencement of the magnetic storm of May 8, 1902, and the eruption of Mont Pelée has been already referred to (§57), and a further discussion was promised. We see from Tables LXII to LXV that at Kew, Colaba, Mauritius and Christchurch—and the same is true of Falmouth—the movement was of the same type A as other sudden commencements of storms. The only peculiarity was that at Kew and Falmouth—and possibly at Colaba—there was a short suspension of the upward movement in H, only just recognisable in the curve. In the Antarctic the movement, it is true, was represented by an oscillatory A and B movement—instead of by a simple A movement—but a similar phenomenon occurred on December 14, 1903. There seems thus to be nothing of an outstanding character in the type of the commencing disturbance of May 8. As regards the relative amplitudes of the disturbance at different stations, there is nothing at all outstanding in the ratio recorded on this occasion in Table LXVIII. The Colaba disturbance was certainly relatively larger than usual, though not so large relatively as two hours later in the same day, and the Mauritius disturbance was also a little above average; but there is nothing at all abnormal in the figures at these stations. Moreover, the fact, that relatively considered the Kew and Falmouth disturbances are somewhat less than usual compared to those at Colaba and Mauritius, is the reverse of favourable to the view that the disturbance was directly due to the Mont Pelée eruption. If an eruption, which consists of a vertical movement of material, causes a magnetic disturbance, one would certainly expect it to be of a more or less symmetrical character round the vertical at the place, and one would unquestionably expect the disturbance to fall off rapidly as the distance increases. Now, somewhat curiously, Colaba, Mauritius and Christchurch are not far from equidistant from Martinique, all being at an angular distance fully double that of Kew and

Falmouth; and Winter Quarters, though nearer than the first three of these stations, is comparatively little nearer. The angular distances are, in short, approximately as follows: Christchurch  $126^\circ$ , Colaba  $123\frac{1}{2}^\circ$ , Mauritius  $121\frac{1}{2}^\circ$ , Winter Quarters  $113^\circ$ , Kew  $60\frac{3}{4}^\circ$ . Thus, if the disturbance had been a direct consequence of the eruption, what we would have expected to find would have been disturbances of nearly equal magnitude at Christchurch, Colaba, Mauritius, and Winter Quarters, that magnitude being much less than that of the disturbance at Kew and Falmouth. Whereas we see from Table LXVIII that the disturbance at Winter Quarters was of the order of ten times that at Christchurch, while the disturbance at Colaba exceeded that at Kew.

Again, if the commencement of the May 8 storm was directly due to the eruption, what are we to think of the remainder of the storm which lasted 8 hours and presented a remarkable unity of appearance; and how are we to explain the fact that the largest movements occurred 6 or 7 hours after the commencement, and that one of these movements, viz., that occurring between 7.4 and 7.11 p.m., G.M.T., presented at Kew, Colaba and Mauritius a remarkable similarity in type to the commencing movement? The conclusion we seem led to is that the coincidence in time with the eruption was purely accidental.

§101. The bearing of the results of Tables LXII to LXVIII on theory calls for a short comment. We have found that disturbances of comparatively short period—whether commencements of magnetic storms or not—show a general tendency to approximate to one or other of a small number of types. Except at Christchurch, in the case of the special type of disturbance, there was no very clear indication of more than two classes, confining ourselves, of course, to cases in which a distinct correspondence was visible between synchronous disturbances at distant stations. In the limited number of cases we have considered, there has also been—apart from the special type of disturbance—a general tendency for disturbances to be larger at some stations than others.

On what I have called the action-at-a-distance theory this would imply that the disturbing field supposed has a tendency to have a more or less fixed direction relative to axes fixed in the Earth. If the direction assumed by that field were largely variable—as it would be if it pointed to the Sun, or were at right angles to the line joining the Earth and Sun—then one would expect the maximum disturbance to be experienced at widely different places on different occasions. The sudden commencements we have had to do with occurred at different times, G.M.T., that of May 8, 1902, being near Greenwich noon, those of April 5 and August 25, 1903, near Greenwich midnight. Again, the sudden commencements were at widely different seasons of the year, yet we do not find any conspicuous difference between the phenomena experienced.

As already remarked, Christchurch is not very far from being a diametral point to Falmouth and Kew, and on the action-at-a-distance theory we should expect the disturbance vectors at diametral points to be parallel in direction and equal in magnitude. So far as the parallelism in direction is considered, there is unquestionably considerable support to the theory. If we take Table LXVII for instance, we have for the first five (or really seven) disturbances:—

	$\theta$ .					$\phi$ .				
	°	°	°	°	°	°	°	°	°	°
Kew . . . . .	71	118	112	121	64	219	48	31	41	207
Christchurch . . . . .	62	111	127	128	40	222	44	32	34	175
Kew less Christchurch . .	+ 9	+ 7	- 15	- 7	+24	- 3	+ 4	- 1	+ 7	+ 32

There is here unquestionably a somewhat remarkable accordance. When, however, we come to the magnitude of the vectors, we find that the disturbance at Christchurch was invariably less than half that at Kew.

When considering the significance of the vector angles  $\theta$  and  $\phi$  there is one point that should be borne in mind. The assumption by a vector of a nearly constant direction unquestionably suggests the action of an external force having also a nearly fixed direction. It may mean, however, no more than that the action of any external impulse tends to influence the Earth's magnetism in a particular way, just as when

one hits a bar magnet in a neutral field one usually knocks out magnetism irrespective of where and how one hits it.

Suppose, for instance, that at each station we had a change only in H, the horizontal component of the Earth's field, then the vectors we should deduce at the several stations would have the following values for  $\theta$  and  $\phi$ , supposing H to increase at all:—

	Kew.	Colaba.	Mauritius.	Christchurch.	Antartic.
$\theta$	53	19	22	46	101
$\phi$	201	253	33	196	319

Under the circumstances supposed, these angles would be independent of the size of the change in H.

An examination of Tables LXII to LXVII will show that the values of  $\theta$  and  $\phi$  thus found are in no case very remote from the values actually calculated for these angles in the case of the disturbances classed as A.

One phenomenon that unquestionably tells against the action-at-a-distance theory is that at all the stations considered  $\Delta V$  is invariably less than the resultant horizontal component  $\sqrt{\Delta N^2 + \Delta E^2}$  of the disturbing vector. The horizontal component is usually much the larger, even in the Antarctic, where the disturbances are greatest.

Whatever other conclusion may be drawn from this investigation, it is, I think, clear that the application of the method to a variety of disturbances drawn from different hours of the day, G.M.T., and from different seasons of the year offers a promising field of research.

TABLE LXII.—Disturbance Components and Resultants at Kew. (Unit of force 1 $\gamma$ .)

Date and time (G.M.T.).	$\Delta N$ .	$\Delta E$ .	$\Delta V$ .	$\Delta X$ .	$\Delta Y$ .	$\Delta Z$ .	$\Delta R$ .	$\theta$ .	$\phi$ .	Type.
1902										
May 8, 11.59 a.m. to 0.4 p.m.	+ 8.0	- 4.6	0.0	- 4.6	- 6.3	+ 5.0	9.3	57	216	A
" 8, 0.4 p.m. " 0.9 "	+ 7.2	- 7.2	0.0	- 7.2	- 5.7	+ 4.5	10.2	64	232	A
" 8, 11.59 a.m. " 0.9 "	+ 15.1	- 11.9	0.0	- 11.9	- 11.8	+ 9.4	19.2	61	225	A
" 8, 2.10 p.m. " 2.28 "	- 5.2	+ 7.2	0.0	+ 7.2	+ 4.0	- 3.2	8.9	111	61	B
" 8, 7.4 " " 7.11 "	+ 15.9	- 16.6	+ 4.0	- 16.6	- 14.9	+ 5.8	23.1	75	228	A
August 20, 9.6 " " 9.10 "	+ 12.5	- 7.1	+ 1.0	- 7.1	- 10.4	+ 7.0	14.4	61	214	A
1903										
April 5, 11.25 p.m. to 11.29 p.m.	+ 34.2	- 28.8	+ 5.2	- 28.8	- 30.0	+ 17.2	45.0	68	224	A
June 19, 7.38 a.m. " 7.55 a.m.	- 12.4	+ 2.1	0.0	+ 2.1	+ 9.7	- 7.8	12.6	128	12	B
" 19, 7.55 " " 8.13 "	+ 1.4	+ 4.6	0.0	+ 4.6	- 1.1	+ 0.9	4.8	79	103	A?
" 28, 8.36 " " 8.47 "	- 7.7	- 11.8	0.0	- 11.8	+ 6.0	- 4.8	14.1	110	297	B
" 28, 8.47 " " 9.8 "	+ 8.5	- 4.9	0.0	- 4.9	- 6.6	+ 5.3	9.8	57	217	A
" 29, 8.59 " " 9.26 "	- 9.3	- 5.1	0.0	- 5.1	+ 7.3	- 5.8	10.6	123	325	B
" 29, 9.26 " " 9.53 "	+ 0.3	- 14.7	0.0	- 14.7	- 0.2	+ 0.2	14.7	89	269	A
July 26, 6.23 " " 6.55 "	- 39.9	- 11.1	- 1.0	- 11.1	+ 31.8	- 24.1	41.4	126	341	B
" 26, 6.55 " " 7.30 "	+ 22.8	- 16.4	+ 4.0	- 16.4	- 20.3	+ 11.0	28.3	67	219	A
August 25, 10.57 p.m. " 11.0 p.m.	- 4.7	+ 5.3	0.0	+ 5.3	+ 3.6	- 2.9	7.0	114	56	B
" 25, 11.0 " " 11.3 "	+ 30.7	- 16.0	0.0	- 16.0	- 24.0	+ 19.1	34.6	56	214	A
Mean from sudden commencements of May 8 and August 20, 1902, April 5 and August 25, 1903, taken until end of rise in H . . . . .	+ 23.1	- 16.0	+ 1.5 <sub>6</sub>	- 16.0	- 19.0	+ 13.2	28.1	62	220	A
Mean from oscillations of June 19, 28, and 29, and July 26, 1903—										
First movement . . . . .	—	—	—	- 6.5	+ 13.7	- 10.6	18.5	125	335	B
Second " . . . . .	—	—	—	- 7.8	- 7.0	+ 4.4	11.4	68	228	A



TABLE LXIII.—Disturbance Components and Resultants at Colaba. (Unit of force  $1\gamma$ .)

Date and time (G.M.T.).	$\Delta N.$	$\Delta E.$	$\Delta V.$	$\Delta X.$	$\Delta Y.$	$\Delta Z.$	$\Delta R.$	$\theta.$	$\phi.$	Type.
1902										
May 8, 11.59 a.m. to 0.9 p.m.	+19.0	+7.6	-7.0	+2.7	-7.2	+20.2	21.6	21	159	A
" 8, 2.10 p.m. " 2.28 "	-11.2	-3.7	+3.2	-0.5	+3.7	-11.6	12.2	162	352	B
" 8, 7.4 " " 7.11 "	+18.4	+3.7	-6.5	+1.2	-3.5	+19.5	19.8	11	160	A
August 20, 9.6 " " 9.10 "	+10.2	+2.2	-1.6	-1.1	-2.6	+10.2	10.6	16	203	A
1903										
April 5, 11.25 p.m. to 11.29 p.m.	+25.0	+4.4	-8.3	+1.0	-4.3	+26.3	26.8	11	167	A
July 26, 6.23 a.m. " 6.55 a.m.	-25.6	+2.2	0.0	+8.6	+0.3	-24.2	25.7	160	88	B
" 26, 6.55 " " 7.30 "	+6.1	+5.5	0.0	-0.3	-5.8	+5.8	8.2	45	183	A
August 25, 10.57 p.m. " 11.0 p.m.	-1.5	+2.2	0.0	+1.1	-1.9	-1.4	2.6	123	150	B <sup>P</sup>
" 25, 11.0 " " 11.3 "	+17.4	-1.1	-2.5	-3.5	+0.1	+17.3	17.7	11	272	A
Mean from sudden commencements (same times as for Kew) . . .	+17.9	+3.3	-4.8	-0.2	-3.5	+18.5	18.8	11	184	A

TABLE LXIV.—Disturbance Components and Resultants at Mauritius. (Unit of force  $1\gamma$ .)

Date and time (G.M.T.).	$\Delta N.$	$\Delta E.$	$\Delta V.$	$\Delta X.$	$\Delta Y.$	$\Delta Z.$	$\Delta R.$	$\theta.$	$\phi.$	Type.
1902										
May 8, 11.59 a.m. to 0.9 p.m.	+7.9	-6.2	+4.7	+2.7	+9.0	+5.8	11.1	58	17	A
" 8, 2.10 p.m. " 2.28 "	-4.5	+1.4	-1.6	-1.8	-2.8	-3.7	5.0	138	213	B
" 8, 7.4 " " 7.11 "	+6.1	+1.1	+3.1	+4.8	+1.8	+4.7	7.0	47	69	A
August 20, 9.6 " " 9.10 "	+5.8	-1.0	0.0	+1.2	+1.9	+5.5	5.9	21	32	A

TABLE LXV.—Disturbance Components and Resultants at Christchurch. (Unit of force  $1\gamma$ .)

Date and time (G.M.T.).	$\Delta N.$	$\Delta E.$	$\Delta V.$	$\Delta X.$	$\Delta Y.$	$\Delta Z.$	$\Delta R.$	$\theta.$	$\phi.$	Type.
1902										
May 8, 11.59 a.m. to 0.9 p.m.	+8.3	+3.8	-0.5	-3.1	-5.8	+6.3	9.1	46	208	A
" 8, 2.10 p.m. " 2.28 "	-4.0	-4.3	+0.5	+3.9	+2.9	-3.2	5.8	151	53	B
August 20, 9.6 " " 9.10 "	+5.1	-2.6	0.0	+3.1	-3.1	+3.7	5.7	49	135	A
1903										
April 5, 11.25 p.m. to 11.29 p.m.	+21.6	-6.1	-2.2	+7.7	-12.4	+17.2	22.6	40	148	A
June 19, 7.38 a.m. " 7.55 a.m.	+2.8	-41.9	-6.4	+41.2	+7.8	+6.5	42.4	81	79	C
" 19, 7.55 " " 8.13 "	+22.1	+37.4	+6.0	-34.8	-24.0	+11.9	43.9	74	235	A
" 28, 8.36 " " 8.47 "	-3.4	-36.8	-4.5	+35.8	+10.1	+0.7	37.2	89	74	C
" 28, 8.47 " " 9.8 "	+16.5	+24.1	+4.5	-22.1	-17.5	+8.8	29.5	73	232	A
" 29, 8.59 " " 9.26 "	+1.1	-3.8	0.0	+3.9	-0.3	+0.8	4.0	78	94	C
" 29, 9.26 " " 9.53 "	-16.8	-16.6	0.0	+15.1	+13.5	-12.2	23.6	121	48	B
July 26, 6.23 " " 6.55 "	-26.3	-31.1	-3.2	+28.4	+24.1	-16.9	40.9	114	50	B
" 26, 6.55 " " 7.30 "	+2.1	+33.0	+8.3	-31.8	-11.5	-4.2	34.1	97	250	A
August 25, 10.57 p.m. " 11.0 p.m.	+1.0	+1.7	0.0	-1.6	-0.9	+0.7	2.0	69	241	A
" 25, 11.0 " " 11.3 "	+0.7	-7.4	-1.9	+7.2	+1.8	+1.8	7.6	76	76	C

TABLE LXVI.—Disturbance Components and Resultants at Winter Quarters. (Unit of force 1 $\gamma$ .)

Date and time (G.M.T.).	$\Delta N.$	$\Delta E.$	$\Delta V.$	$\Delta X.$	$\Delta Y.$	$\Delta Z.$	$\Delta R.$	$\theta.$	$\phi.$	Type.
1902								°	°	
May 8, First phase . . . . .	- 14	- 25	0	+ 21	+ 19	- 3.0	28	96	48	A
"   8, Second phase . . . . .	+ 25	+ 45	+ 6	- 38	- 36	- 0.5	52	91	227	B
"   8, 2.10 p.m. to 2.28 p.m. . . . .	- 11	- 36	+ 15	+ 34	+ 15	- 19.6	43	117	66	A
Aug. 20, First phase . . . . .	+ 19	+ 33	+ 1	- 28	- 26	+ 2.8	38	86	228	B
"   20, Second phase . . . . .	- 32	- 50	- 6	+ 42	+ 43	- 0.5	60	90	45	A
1903										
April 5, First phase . . . . .	+ 91	+ 33	- 31	- 14	- 88	+ 49	102	61	189	B
"   5, Second phase (i) . . . . .	-214	-191	+ 87	+144	+229	-130	300	116	32	A
June 19, 7.38 a.m. to 7.55 a.m. (i) . . . . .	+144	+ 81	- 19	- 48	-151	+ 49	166	73	198	B
"   19, 7.55 " " 8.13 " (i) . . . . .	- 90	- 48	+ 53	+ 30	+ 86	- 71	116	128	19	A
"   28, 8.36 " " 8.47 " (i) . . . . .	+162	+169	- 29	-131	-186	+ 62	236	75	215	B
"   28, 8.47 " " 9.8 " (i) . . . . .	-150	- 84	+146	+ 56	+132	-174	225	140	23	A
"   29, 8.59 " " 9.26 " . . . . .	+113	+131	- 2	-104	-137	+ 26	174	81	217	B
"   29, 9.26 " " 9.53 " . . . . .	-127	-111	+ 53	+ 83	+135	- 78	177	116	32	A
July 26, 6.23 " " 6.55 " (i) . . . . .	+ 53	+253	+ 24	-234	-112	- 12	260	93	244	B
"   26, 6.55 " " 7.30 " (i) . . . . .	-107	-223	+ 75	+198	+137	- 96	259	112	55	A
Aug. 25, First phase . . . . .	+ 52	- 2	- 29	+ 12	- 43	+ 39	59	49	164	B
"   25, Second phase . . . . .	-123	- 40	+ 52	+ 15	+115	- 77	139	123	7	A
Mean from sudden commencements on May 8 and August 20, 1902, and August 25, 1903—										
Phase with force decreasing . . . . .	—	—	—	- 18.1	- 34.7	+ 13.8	41.5	71	208	B
"   "   "   increasing . . . . .	—	—	—	+ 26.0	+ 59.0	- 26.7	69.8	112	24	A
Mean from June 19, 28, 29, and July 26, 1903—										
First phase . . . . .	—	—	—	-129	-146	+ 31	198	81	221	B
Second phase . . . . .	—	—	—	+ 92	+122	-105	186	124	37	A
Mean from all complete examples of special type—										
First phase . . . . .	+ 41.5	+ 46.9	- 6.1	- 37.1	- 48.8	+ 14.7	63.0	77	217	B
Second phase . . . . .	- 40.1	- 37.9	+ 21.0	+ 29.3	+ 42.4	- 29.0	59.1	93	35	A

76  
79  
-6  
+12



TABLE LXVIII.—Ratio of Disturbances to those at Kew.

Date and Time (G.M.T.).	Colaba.	Mauritius.	Christchurch.	Winter Quarters.
1902				
May 8—11.59 a.m. to 0.4 p.m. . . . .	—	—	—	3·0
„ 8—0.4 p.m. „ 0.9 „ . . . . .	—	—	—	5·1
„ 8—11.59 a.m. „ 0.9 „ . . . . .	1·13	0·58	0·47	—
„ 8—2.10 p.m. „ 2.28 „ . . . . .	1·37	0·56	0·65	4·8
„ 8—7.4 „ „ 7.11 „ . . . . .	0·86	0·30	—	—
July 24—(1) . . . . .	0·66	0·35	0·41	3·5
„ 24—(2) . . . . .	0·76	0·40	0·47	5·8
„ 24—(3) . . . . .	0·58	0·39	0·25	—
„ 24—(4) . . . . .	0·83	0·53	0·41	—
„ 24—(5) . . . . .	0·19	0·05	0·14	—
„ 24—(6) . . . . .	0·56	0·44	—	—
„ 24—(7) . . . . .	0·59	0·40	—	—
„ 24—(8) . . . . .	0·49	0·32	—	—
August 20—9.6 p.m. to 9.10 p.m. . . . .	0·74	0·41	0·40	4·2
1903				
April 5—11.25 p.m. to 11.29 p.m. . . . .	0·59	—	0·50	2·3
June 19—First phase . . . . .	—	—	3·4	13·2
„ 19—Second „ . . . . .	—	—	9·1	24·2
„ 28—First „ . . . . .	—	—	2·6	16·7
„ 28—Second „ . . . . .	—	—	3·0	23·0
„ 29—First „ . . . . .	—	—	0·38	16·4
„ 29—Second „ . . . . .	—	—	1·6	12·0
July 26—First „ . . . . .	0·62	—	0·99	6·3
„ 26—Second „ . . . . .	0·29	—	1·20	9·2
August 25—First phase . . . . .	0·37	—	0·29	8·5
„ 25—Second „ . . . . .	0·51	—	0·22	4·0
Mean from sudden commencements . . . . .	0·67	0·50	0·38	4·5
Mean, excluding sudden commencements and special type of disturbance. . . . .	0·69	0·37	0·39	4·7
Mean from special type of disturbance . . . . .	0·46	—	2·8	15·1

## CHAPTER X.

## SPECIAL TYPE OF DISTURBANCE.

§102. Reference has already been made, §69, to a "special type" of disturbance in the Antarctic, examples of which are afforded by the curves of June 19, 28 and 29, July 26, and August 17, 1903 (see Plates XXVII-XXXI). The close resemblance of the disturbances of June 28 and 29 first drew my attention, and, in order to judge of the real significance of the apparent repetition of a disturbance at a nearly 24-hour interval, it appeared necessary to examine the curves in detail. Examination soon showed that the type of disturbance was of somewhat frequent occurrence during certain hours of the day.

The essential part of the phenomenon may be regarded as consisting of two phases. During the first there is normally a slight fall in V, during the second there is always a rise, usually considerably larger than the preceding fall.

During the first phase D practically always decreases, and H usually, though not always, does the same. During the second phase the D and H changes are in the opposite direction to those during the first phase

On the crests, so to speak, of the D and H waves minor oscillations usually occur (*cf.* Plate XXIX), also the slope of the V curve near its lowest point is sometimes very slight. Thus the time when the first phase ends and the second begins is usually uncertain to a minute or two, and a greater uncertainty often attaches to the beginning of the first phase and the ending of the second. The main movement was usually accompanied by the minor variations which were of such persistent occurrence in the Antarctic. But these minor movements and the various uncertainties which enter into individual cases will, it is believed, have but little influence on the general conclusions reached below.

What happened after the end of phase 2 varied a good deal. June 29, 1903, represents the most usual order of events. Here V remains nearly uniform for some time. Not infrequently, however, after reaching a maximum V made some further oscillations, and then diminished somewhat rapidly, as in the curve of June 28, 1903 (Plate XXVIII).

In some cases the to-and-fro movements in D and H were closely alike; in other cases there was a good deal of asymmetry. In some cases the return wave, so to speak, was checked by what seemed to be a second wave surging in before normal conditions had been restored. In a few instances there were two complete examples of the phenomenon in a single day, and once or twice in immediate sequence to one another.

As will be seen presently, the great majority of the occurrences took place between 6 and 10 p.m. (local time), no occurrences being noted from 2 a.m. to 1 p.m. There is, however, more than one possible explanation of this fact. At most seasons of the year the type of the disturbed movements varied throughout the 24 hours. During the afternoon, up to 10 or 11 p.m., the curves exhibited a marked tendency to rounded swelling movements, like a succession of irregular waves with a considerable interval between the crests. There were incessant minor oscillations superposed on these, but they did not usually obliterate the long-period waves. In the early forenoon, on the other hand, slow-swelling movements were rarely recognisable, while short-period oscillations became dominant, the curves appearing tumultuously irregular and highly disturbed.

The hour marks in the D, H and V curves were seldom exactly in a line transverse to the hour lines, and in the case of these short-period oscillations it was exceedingly difficult to decide whether crests on the different curves answered exactly to one another. It is by no means improbable that microscopic examination of the curves would have shown a number of cases in the morning where phenomena of the type now being discussed occurred, only with the phases much shortened. In many morning disturbances it was clear that a turning-point answering to the minimum value of D during a rapid to-and-fro movement answered, at least very approximately, to the lowest point of a sharp V depression. There were, however, usually a succession of crests and depressions on the V traces at such times, the successive waves tending to become confused,

§103. Table LXIX gives particulars of the 82 cases of the phenomenon actually found. It gives the date, the approximate hour answering to the end of the first phase and the beginning of the second, the duration of each phase, and the results of the curve measurements. A double entry, e.g.  $\frac{-5}{+15}$ , in the D column means that the turning-point on the D curve occurred distinctly after the time taken as the ending of the first phase, the fall experienced during the first phase continuing for a short time, and being then followed by a larger rise. The addition of a + after a figure means that the trace went beyond the limit of registration to which the figure given answers. In such a case the amplitude assigned is, of course, an underestimate.

TABLE LXIX.—Special Type of Disturbance. Occurrences.

Date.	End of first phase.	First phase.				Second phase.			
		Duration.	Amplitudes of movements.			Duration.	Amplitudes of movements.		
			D.	H.	V.		D.	H.	V.
1902	h. m.	mins.	'	γ	γ	mins.	'	γ	γ
March 22 . .	8 0 p.m.	15	- 54	+77 <sub>+</sub>	0	35	+ 51	- 78 <sub>+</sub>	+ 30
" 24 . .	8 30 "	18	- 20 <sub>+</sub>	—	- 3	18	+ 22 <sub>+</sub>	—	+ 36
" 24 . .	11 30 "	24	-113 <sub>+</sub>	—	-48	21	+ 72 <sub>+</sub>	—	+ 56
April 8 . .	9 6 "	12	- 25	-80 <sub>+</sub>	-10	29	+ 30	+102 <sub>+</sub>	+ 33
" 28 . .	5 9 "	15	- 33	+ 6	0	15	+ 34	0	+ 20
June 12 . .	7 45 "	13	- 60	0	- 4	22	+ 72	0	+ 46
" 16 . .	8 14 "	23	- 34	-29	- 3	24	+ 31	+ 39	+ 29
" 20 . .	4 55 "	15	- 15	+17	0	20	+ 15	- 14	+ 7
" 22 . .	8 50 "	20	- 37	-28	- 7	45	+ 30	+ 20	+ 36
" 27 . .	6 15 "	15	- 34	+21	- 1	12	+ 18	- 7	+ 15
" 27 . .	8 50 "	20	- 36	-22	- 9	8	+ 18	+ 11	+ 17
" 29 . .	8 24 "	20	- 66	-38	-15	20	+ 27	+ 17	+ 44
July 1 . .	6 48 "	12	- 36	-17	-16	15	+ 35	+ 31	+ 32
" 5 . .	9 24 "	18	- 27	-38	- 8	20	+ 23	+ 39	+ 24
" 6 . .	7 42 "	20	- 22	+ 6	- 4	24	+ 21	+ 4	+ 11
" 12 . .	8 10 "	20	- 60	-31	- 1	20	+ 44	+ 31	+ 38
" 16 . .	7 10 "	14	- 30	- 8	- 3	25	+ 23	+ 13	+ 14
" 18 . .	8 44 "	20	- 15	-20	- 1	24	+ 18	+ 21	+ 4
" 23 . .	5 45 "	23	- 18	+15	0	25	+ 14	- 8	+ 15
" 25 . .	8 0 "	18	- 62	-39	- 4	24	+ 68	+ 20	+ 34
August 1 . .	7 40 "	12	- 21	-11	- 8	15	+ 21	+ 11	+ 10
" 3 . .	3 48 "	18	- 17	+24	0	22	+ 14	- 15	+ 4
" 3 . .	4 30 "	20	- 34	+21	- 4	20	+ 27	- 6	+ 13
" 4 . .	5 10 "	22	- 26	+34	+ 3	28	+ 30	- 18	+ 23
" 9 . .	8 40 "	14	- 18	-10	- 3	15	+ 12	+ 7	+ 10
" 11 . .	3 58 "	18	- 36	+17	- 4	13	+ 39	- 27	+ 13
" 11 . .	5 23 "	20	- 21	+11	0	19	+ 31	- 11	+ 6
" 14 . .	8 2 "	13	- 22	-22	- 5	22	+ 21	+ 25	+ 13
" 22 . .	2 3 "	15	- 38	-38	-44	24	{ - 18 + 55 }	+ 62	+ 69
" 22 . .	8 16 "	32	- 68	-50 <sub>+</sub>	- 5	44	+120	+ 53 <sub>+</sub>	+ 55
" 23 . .	7 10 "	22	- 50	-45	-21	20	+ 38	+ 40	+ 34
" 24 . .	3 18 "	20	- 36	-28 <sub>+</sub>	0	17	+ 30	+ 17 <sub>+</sub>	+ 19
" 25 . .	5 36 "	12	- 21	+11	- 3	15	+ 20	- 6	+ 3
" 25 . .	6 6 "	15	- 27	-14	- 8	20	+ 26	+ 11	+ 13
" 28 . .	7 20 "	18	- 12	- 8	- 4	13	+ 33	+ 7	+ 11
" 30 . .	6 42 "	18	- 22	-11	- 4	16	+ 18	+ 9	+ 10
" 30 . .	7 13 "	15	- 11	-18	-10	14	+ 17	+ 18	+ 16
" 31 . .	8 54 "	18	- 90	-66 <sub>+</sub>	-23	28	{ - 9 + 77 }	+ 71 <sub>+</sub>	+ 56
September 23 . .	7 45 "	23	- 24	-43	-18	31	+ 20	+ 40	+ 33
" 23 . .	8 47 "	22	- 17	-35	-21	19	+ 15	+ 31	+ 24
October 4 . .	11 19 "	20	+ 18	-50 <sub>+</sub>	-12	41	- 21	+ 54 <sub>+</sub>	+ 54
November 1 . .	5 0 "	12	- 28	+21 <sub>+</sub>	- 2	16	+ 25	- 11 <sub>+</sub>	+ 6
" 25 . .	10 36 "	24	- 50	-70	-14	27	{ - 15 + 82 }	+ 63	+ 58

778

945

TABLE LXIX (continued).

Date.	End of first phase.	First phase.				Second phase.			
		Duration.	Amplitudes of movements.			Duration.	Amplitudes of movements.		
			D.	H.	V.		D.	H.	V.
1903	h. m.	mins.	'	γ	γ	mins.	'	γ	γ
January 12 . . .	1 0 a.m.	15	- 45	-11	-12	24	+ 46	+ 8	+ 33
February 2 . . .	4 27 p.m.	9	- 61	-30	- 7	9	+ 60	+ 19	+ 17
March 28 . . .	9 56 "	26	- 6	-30	- 2	26	+ 6	+ 26	+ 8
April 21 . . .	7 0 "	10	- 46	-22	-16	16	+ 26	+ 28	+ 32
May 6 . . .	10 6 "	9	- 48	-40 <sub>+</sub>	-26	24	{ - 24 <sub>+</sub> + 52 <sub>+</sub> }	+ 25 <sub>+</sub>	+ 97
" 7 . . .	6 45 "	13	- 43	-20	-10	18	+ 27	+ 57	+ 16
" 8 . . .	8 13 "	13	- 26	-20	- 6	15	+ 23	+ 15	+ 16
" 8 . . .	8 50 "	17	- 22	-55	-11	18	+ 17	+ 66	+ 32
" 19 . . .	7 26 "	13	- 17	-10	- 5	16	+ 17	+ 11	+ 15
" 22 . . .	8 3 "	21	- 30	-45	-10	33	{ - 12 + 27 }	+ 44	+ 32
" 28 . . .	10 54 "	24	{ + 7 - 12 }	-43	- 6	13	{ - 5 + 6 }	+ 24	+ 11
" 29 . . .	3 5 "	20	- 20	+40 <sub>+</sub>	0	18	+ 36	- 27 <sub>+</sub>	+ 15
June 9 . . .	9 24 "	16	- 21	-15	- 2	18	+ 22	+ 20	+ 8
" 10 . . .	7 38 "	11	- 15	-19	- 5	13	+ 15	+ 26	+ 16
" 10 . . .	8 5 "	14	- 10	-27	-11	9	+ 10	+ 15	+ 10
" 16 . . .	10 26 "	10	- 12	-28	- 6	16	+ 10	+ 21	+ 15
" 17 . . .	6 30 "	25	- 50	-19	- 8	24	+ 32	+ 17	+ 19
" 19 . . .	7 1 "	21	- 72	-91 <sub>+</sub>	-19	19	+ 44	+ 58 <sub>+</sub>	+ 53
" 25 . . .	7 18 "	12	- 30	-37	-10	20	+ 8	+ 31	+ 23
" 28 . . .	7 54 "	11	-117 <sub>+</sub>	-66	-29	21	+ 75 <sub>+</sub>	+ 95	+146
" 29 . . .	8 33 "	27	- 88	-40	- 2	27	{ - 9 + 83 }	+ 62	+ 53
July 3 . . .	2 32 "	10	- 29	-42 <sub>+</sub>	-10	14	+ 33	+ 40 <sub>+</sub>	+ 31
" 3 . . .	9 54 "	12	- 10	-11	- 6	8	+ 9	+ 13	+ 6
" 6 . . .	7 21 "	14	- 47	-46	- 8	19	{ - 12 + 60 }	+ 57	+ 73
" 7 . . .	4 33 "	15	- 29	-17	- 2	8	+ 23	+ 17	+ 13
" 10 . . .	9 2 "	11	- 27	-14	- 5	10	+ 9	+ 5	+ 11
" 13 . . .	7 26 "	11	- 48	+35	- 3	15	+ 32	- 22	+ 32
" 14 . . .	7 18 "	11	- 27	-12	-10	19	+ 27	+ 7	+ 18
" 19 . . .	1 30 a.m.	12	- 29	-23	-13	18	+ 50	+ 48	+ 29
" 21 . . .	3 44 p.m.	12	- 40	+38	- 5	31	{ - 18 + 52 }	- 10 <sub>+</sub>	+ 87
" 26 . . .	5 55 "	25	-131 <sub>+</sub>	+69 <sub>+</sub>	- 3	33	+120 <sub>+</sub>	- 6 <sub>+</sub>	+117
August 3 . . .	8 39 "	15	- 18	-22	- 3	18	+ 18	+ 27	+ 15
" 11 . . .	8 10 "	20	- 66	-40	- 3	26	+ 53	+ 79	+ 84
" 15 . . .	8 33 "	23	- 23	-29	0	15	+ 27	+ 20	+ 11
" 17 . . .	7 54 "	22	- 54	-48 <sub>+</sub>	-19	21	+ 36	+ 43 <sub>+</sub>	+ 44
September 29 . . .	5 27 "	27	-104	-36	+ 3	16	+120	+ 46	+ 49
" 30 . . .	5 15 "	15	- 78	-13	- 3	20	+ 45	+ 36	+ 41
October 7 . . .	7 19 "	15	- 54	-20 <sub>+</sub>	-16	23	+ 82	+ 23 <sub>+</sub>	+ 34
" 27 . . .	7 15 "	8	- 27	-40 <sub>+</sub>	- 8	27	{ - 6 + 40 }	+ 55 <sub>+</sub>	+ 29

615

738

13

20

§104. Table LXX summarises the results from the whole 82 occurrences as to the hour at which the first phase ended. An occurrence at an exact hour was assigned to the hour then commencing. It will be seen that more than half the occurrences happened between 7 and 9 p.m. There is no marked seasonal variation in the hour of occurrence. A larger proportion of occurrences took place after 8 p.m. in April, May and June than in July, August and September, but that might be accidental. The great concentration of occurrences near 8 p.m. is obviously a vital point when considering the real significance of the sequence presented in the disturbances of June 28 and 29, 1903.

TABLE LXX.—Hour of Occurrence of End of First Phase.

Hour ending . . .	P.M.										A.M.		Total.
	3.	4.	5.	6.	7.	8.	9.	10.	11.	Midt.	1.	2.	
April and May . . . . .	—	1	—	1	1	2	3	1	2	—	—	—	11
June . . . . .	—	—	1	—	2	5	6	1	1	—	—	—	16
July . . . . .	1	1	1	2	1	5	3	3	—	—	—	1	18
August . . . . .	1	3	1	3	2	5	7	—	—	—	—	—	22
September . . . . .	—	—	—	2	—	1	1	—	—	—	—	—	4
Other months . . . . .	—	—	1	1	—	2	2	1	1	2	—	1	11
<b>Total . . . . .</b>	<b>2</b>	<b>5</b>	<b>4</b>	<b>9</b>	<b>6</b>	<b>20</b>	<b>22</b>	<b>6</b>	<b>4</b>	<b>2</b>	<b>—</b>	<b>2</b>	<b>82</b>

§105. Table LXXI gives particulars of the average duration of the two phases, again from the whole 82 occurrences. There seems a distinct tendency for the second phase to last the longer, though instances in which the reverse is true are not rare. There seems no marked seasonal variation in the duration of the phases. There is an apparent difference between 1902 and 1903 which may be real. 1902 was a year of very small sun-spot frequency (WOLFER'S relative value 5·0), while 1903 had a considerably larger frequency (WOLFER'S value 24·4) and showed larger magnetic ranges both for the regular and irregular variations.

TABLE LXXI.—Duration of Phases (Minutes).

	First phase.			Second phase.		
	1902.	1903.	1902 and 1903.	1902.	1903.	1902 and 1903.
April and May . . . . .	13·5	15·6	15·2	22·0	19·0	19·5
June . . . . .	18·0	16·3	17·1	21·6	18·6	19·9
July . . . . .	18·1	13·3	15·4	22·1	17·5	19·6
August . . . . .	17·9	20·0	18·3	20·2	20·0	20·1
September . . . . .	22·5	21·0	21·7	25·0	18·0	21·5
Other months . . . . .	18·8	14·6	16·9	26·3	21·8	24·3
<b>Means . . . . .</b>	<b>18·1</b>	<b>15·8</b>	<b>17·0</b>	<b>21·9</b>	<b>18·9</b>	<b>20·5</b>

§106. An attempt was made to arrive at a more exact idea of the type of disturbance by forming means based on a number of days. Only those occurrences were used for which the trace was complete. Incompleteness was naturally most common in the larger disturbances, so that the mean results obtained somewhat underestimate the average amplitude. Occurrences in which the phases in the different elements did not synchronise, or which were ill defined, were also omitted. The 51 occurrences which remained were grouped according to the season of the year as shown in Table LXXII, which gives the mean results obtained. The Declination results are expressed not in minutes of arc, but in units of force, replacing 1' by 1·92γ as the force acting perpendicular to the magnetic Meridian necessary to alter the direction of the Declination needle by one minute of arc.



TABLE LXXII.—Amplitude and Direction of Disturbing Force.

	Number of observations.	$\Delta D.$	$\Delta H.$	$\sqrt{(\Delta D)^2 + (\Delta H)^2}$	$\Delta V.$	$\Delta T.$	$\psi.$	$\chi.$
First phase—								
April and May . . . . .	6	$\gamma$ - 58.8	$\gamma$ - 20.2	$\gamma$ - 63.2	$\gamma$ - 8.0	$\gamma$ 63.7	$^{\circ} /$ 71 22	$^{\circ} /$ 7 13
June . . . . .	11	- 60.2	- 21.9	- 60.9	- 7.0	61.3	81 25	6 33
July . . . . .	13	- 61.7	- 13.8	- 63.2	- 5.5	63.5	77 22	5 0
August . . . . .	17	- 50.2	- 6.6	- 50.7	- 4.5	50.9	82 32	5 6
September . . . . .	4	- 107.0	- 31.7	- 111.7	- 9.8	112.0	73 29	4 59
All . . . . .	51	- 60.9	- 15.3	- 62.8	- 6.1	63.1	75 53	5 35
Second phase—								
April and May . . . . .	6	+ 46.1	+ 29.5	+ 54.7	+ 21.8	59.0	57 22	21 45
June . . . . .	11	+ 38.6	+ 19.1	+ 43.0	+ 21.1	47.9	63 40	26 6
July . . . . .	13	+ 55.4	+ 16.5	+ 57.7	+ 20.8	61.5	73 22	19 46
August . . . . .	17	+ 50.2	+ 10.1	+ 51.2	+ 17.0	54.0	78 41	18 21
September . . . . .	4	+ 96.0	+ 38.2	+ 103.2	+ 36.7	109.8	68 16	19 35
All . . . . .	51	+ 52.2	+ 18.2	+ 55.2	+ 21.0	59.1	70 48	20 47

To explain Table LXXII let us consider the mean result from all the observations, which may be assigned to a single representative occurrence of the phenomenon.

In the figure, NS, EW are the geographical north-south and east-west directions, while *nos* represents the position of the Declination needle, *n* being the north pole. Taking as point of departure the position existing at the commencement of the first phase, the force required to produce the disturbance existing at the end of that phase called for the action on the pole *n* of a force whose horizontal components were  $60.9\gamma$  perpendicular to *no*, and  $15.3\gamma$  along *no*, in the directions shown, the vertical component being  $6.1\gamma$  downwards. The resultant of the two horizontal components amounted to  $62.8\gamma$ , and its inclination  $\psi$  to *no* was  $75^{\circ} 53'$ . The total force  $\Delta T$ , obtained by combining the horizontal resultant with the Vertical Force  $6.1\gamma$ , amounted to  $63.1\gamma$ , and its inclination  $\chi$  to the horizontal plane was  $5^{\circ} 35'$ . The direction of  $\Delta T$  pointed below the surface of the ground.

For the second phase we take the position at the end of the first phase as point of departure. To produce the disturbance existing at the end of the second phase required the forces shown in the second half of the table. The accompanying figure illustrates the results in the horizontal plane answering to the mean or representative occurrence. The resultant of the Horizontal Forces,  $55.2\gamma$ , is inclined at  $70^{\circ} 48'$  to *on* produced. It is thus not exactly opposite to the corresponding force experienced during the first phase, the two being inclined at approximately  $175^{\circ}$ . The Vertical Force in the second phase is nearly  $3\frac{1}{2}$  times that in the first, so that the angle  $\chi$ , which the total disturbing force  $\Delta T$  now makes with the horizon, is increased to  $20^{\circ} 47'$  and points above the horizon.

There were only four occurrences in September, thus little significance attaches to the large size of the average disturbance for that month.

§107. The data on which Table LXXII depends were all got out before any anticipation was made as to

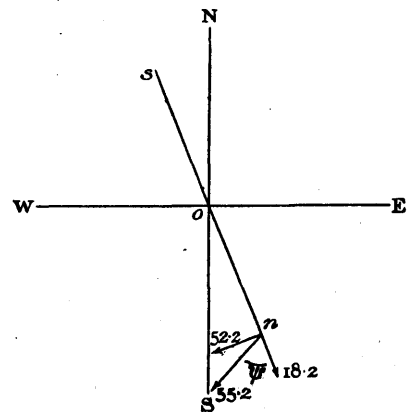
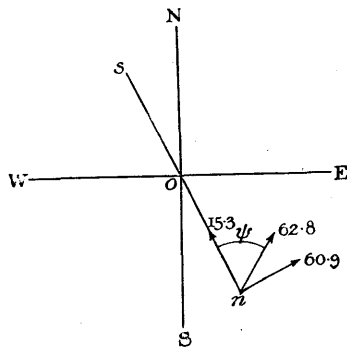

the probable result, or any plan existed for combining the observations. Thus the remarkable similarity in the values obtained for  $\psi$  and for  $\chi$  from the several months owes nothing to any preconceived ideas.

Whatever may be the cause of the phenomenon, it is clear that so far as the forces in the horizontal plane are concerned the second phase may be regarded, to a first approximation, as simply a relaxation of the forces to which the first phase is due. On the average, D ends by being about 4' (or  $8\gamma$ ) smaller, and H by being about  $3\gamma$  larger than at the start. In the case of V, however, there is something more than a mere relaxation, the "recovery" during the second phase being, on the average,  $3\frac{1}{2}$  times the drop during the first phase.

It must not, of course, be forgotten that during the disturbance the ordinary diurnal changes may naturally be expected to go on as usual. The hour of occurrence being variable, it is difficult to allow very exactly for this. If, however, we take the mean diurnal inequalities for Midwinter as the most nearly applicable, we find that during the average occurrence of the phenomenon the regular change would be practically nil in D, about  $-2.6\gamma$  in H, and about  $+0.6\gamma$  in V. The subtraction of the effects of these regular changes makes but little difference to the results, especially as regards the amplitudes. For the angles in the case of the representative disturbance the results in Table LXXII are altered to

	$\psi$ .	$\chi$ .
First phase . . . .	77° 3'	5° 51'
Second phase . . . .	69° 31'	20° 23'

§108. As to the possible cause of the special type of disturbance, the results derived from the co-operating stations suggest that its seat is, mainly at least, in the southern hemisphere, but it is clearly not a purely local phenomenon. The disturbances experienced at Christchurch, on the occasions for which Christchurch data existed, averaged in amplitude about a fifth of those experienced at Winter Quarters. If the cause is electric currents, the absence at Winter Quarters of any large vertical component during the first phase suggests a nearly uniform current sheet overhead, or else underground currents having similar direction and intensity over a considerable area, or a combination of the two sets of currents.

If we take the value  $75^{\circ} 53'$  for  $\psi$  during the first phase, and assume the local magnetic Meridian to be  $152^{\circ} 40'$  E., then the direction of the hypothetical currents would be

if overhead, from N.W. to S.E. (more exactly, from  $48^{\circ} 33'$  to north of west),

if underground, from S.E. to N.W. (more exactly, from  $48^{\circ} 33'$  to south of east).

Judging by the solitary observation on the ice\* on January 30, 1904, the undisturbed magnetic Meridian was about  $148^{\circ}$  E., and the inclination of the hypothetical currents to this is roughly  $9\frac{1}{2}^{\circ}$ . The small vertical component seen during the first phase might be explained by supposing that the intensity of the currents varied slightly with the distance to N.E. or S.W. from Winter Quarters.

The fact that after the horizontal movements had subsided there remained an enhanced value of the Vertical Force might be explained by supposing that the current system or systems did not really die out, but moved, if overhead towards the S.W., if underground towards the N.E. Or the explanation might be that the currents had in reality circular paths and tended to magnetise the Earth, producing a S-pole in the neighbourhood of Winter Quarters, which usually showed marked hysteresis in its disappearance.

In our present state of knowledge it would be pretty much pure accident if one happened to hit on the true explanation. But there are certain conclusions which may usefully be drawn.

The existence of such a phenomenon as the special type of disturbance emphasises the importance of simultaneous observations not merely from ordinary observatories, but from stations much less remote from the Antarctic station. If such stations existed, and were within reach of one another by wireless telegraphy, and if observations on earth currents and on the transmissibility of wireless signals were included in the programme, there would be a reasonable chance of a satisfactory explanation of the phenomena being reached. If the magnetograms were studied as soon as available, and striking phenomena noticed as they occurred, then, if they repeated themselves, it might be possible to recognise

\* 'Physical Observations,' p. 141.

their occurrence while still incident, and thus to make physical observations likely to discriminate between the different theories proposed.

It would also be of interest to have comparative records from some Arctic station. All the sudden commencements of storms which were recorded at the co-operating stations appeared of enhanced magnitude at Winter Quarters. Unless we suppose them to be due to some source of disturbance peculiar to the southern hemisphere—which seems unlikely considering the size of the disturbances experienced at Kew and Colaba as compared to those at Mauritius and Christchurch—it would appear not unlikely that a similar enhancement would appear at an Arctic station. If this should prove to be the case it would be a most interesting fact, in view especially of the views recently advanced by VILLARD as to the nature of aurora.

## CHAPTER XI.

## COMPARISON OF MAGNETIC DISTURBANCES AND AURORA.

§109. Aurora in England seems always accompanied by more or less magnetic disturbance. Auroras and large magnetic disturbances are both rare events in the south of England, so that when a conspicuous aurora and a large magnetic storm occur there simultaneously, the inference that the coincidence is not a mere accident is almost inevitable. In the Arctic and Antarctic regions, however, magnetic disturbance is the rule rather than the exception, and if the same is not equally true of aurora, still aurora is so often visible that even if no physical connection existed between the two phenomena, accidental coincidences would naturally occur. During several Arctic expeditions—*e.g.* those in the polar year 1882—elaborate auroral observations have been carried out, and special attention has been given to the question of the relationship to magnetic storms. The general conclusion reached seems to be that many Arctic auroras are unaccompanied by any noteworthy magnetic disturbance, but that auroras of a specially vivid and rapidly changing character are usually accompanied by marked magnetic disturbance.

In considering the incidence of auroras there is the serious complication that to be visible an aurora must occur when there is no other source of light sufficiently bright to render it invisible. Thus aurora is seldom if ever seen until the Sun is below the horizon, and even moonlight, when the Moon is near the full, suffices to render any but specially bright auroras invisible. The state of the sky as to clouds is also important. Faint auroras of limited extent have a better chance of being seen when clouds are few than when they are many.

Again, there is the fact that while the record of magnetic storms, thanks to magnetographs, goes on equally well in the absence of trained observers, this is not the case with auroras. At Winter Quarters the Meteorological Observers were on the outlook for aurora at the two-hourly observation hours, right through the 24 hours. Specially bright auroras would also naturally attract the attention of the watch on deck, whose instructions under these circumstances were to call Mr. BERNACCHI. Still, during the night, a display of less than two hours' duration, if faint or only moderately bright, might fail to be noted. Thus the fact that at an observation hour when aurora was noted the magnetic curves were quieter than half an hour before or after, when no aurora was noted, may not possess any real significance.

§110. The magnetic curves, when existent, were examined at all the times at which auroras appear on Mr. BERNACCHI'S list.\*

Before considering the results of this comparison, the following particulars of the auroral statistics may be mentioned.† The auroras recorded, with two exceptions occurring late in March, were limited to the six months April to September, the days on which they were observed being distributed as follows:—

	March.	April.	May.	June.	July.	August.	September.	Total days.
1902 . . . . .	—	10	8	12	10	9	3	52
1903 . . . . .	2	18	14	18	22	14	2	90
Total . . . . .	2	28	22	30	32	23	5	142

Thus the auroras seen were practically limited to the four months April to August, and so to the season of the year when magnetic movements, both regular and irregular, were smallest.

\* "Physical Observations," p. 101.

† *Cf.* "Physical Observations," p. 126.

The absence of auroral records from the remainder of the year means nothing more than "too much daylight," to use Mr. BERNACCHI's words.

Even in the Midwinter months there are gaps in the auroral record: in 1902, from April 16 to May 5, from May 15 to 30, from June 16 to 29, from July 14 to August 4; in 1903, from April 12 to 18, from May 8 to 15, from June 7 to 13, from July 7 to 11, and from July 31 to August 10, all *inclusive*. Of the third of these gaps Mr. BERNACCHI says: "From June 15 to June 30 bright moonlight or overcast skies prevented any aurora being seen," and, presumably, the explanation of the other gaps is similar, as the dates of full Moon were, in 1902, April 23, May 23, June 21, July 20, and, in 1903, April 13, May 12, June 11, July 10, and August 8.

§111. It will be observed that many more auroras were seen in 1903 than in 1902. I am informed by Mr. BERNACCHI that this is not due, at least in any large measure, to difference in the observational methods or increased activity in the observers. It is thus, presumably, a true physical phenomenon. 1902 was near sun-spot minimum, with a WOLFER'S frequency of only 5.0, while the frequency for 1903 was 24.4. In northern *temperate* latitudes auroral frequency normally increases with sun-spot frequency [it is, however, doubtful whether the same is true to the north of the zone of maximum auroral frequency], thus a difference between 1902 and 1903 is not surprising. The difference between the two years seems due partly to the greater length in 1902 of the intervals in which no auroras were observed. This rather suggests that the cause was difference in intensity rather than anything else. In 1903 the average aurora may have been more intense than in 1902, and so have suffered less from the causes tending to render it invisible. Some collateral evidence of this is afforded by a consideration of the number of separate entries of aurora in Mr. BERNACCHI'S list.

On some days aurora is noted at one hour only, but on most days, when it is recorded at all, at several hours.

There is a certain amount of overlapping, so that there may be a trifling error in my estimate of the number of separate entries. The figures show, however, a very large difference between the two years, there being 250 separate entries for 1903 as against 125 for 1902. The ratio 20:10 between these two numbers is substantially larger than the ratio 17:10 between the number of days of aurora in the two years. This obviously supports the view that in 1903 the average aurora retained for a longer time the intensity necessary to render it visible, from which a higher maximum intensity would naturally be inferred.

If this is a main cause of the excess of visible auroras in 1903, then the preceding figures are, at least, strongly suggestive of the view that the phenomena whose visible side is aurora were seldom, if ever, wholly absent on Midwinter days at Winter Quarters. Thus the fact that the magnets were practically never undisturbed for five minutes at a time cannot safely be interpreted as evidence of the continued presence of some cause of irregular magnetic disturbance other than that associated with the seat of aurora.

Another consideration should be borne in mind. Assuming, what few people now doubt to be true, that aurora is the visible manifestation of electrical action in the atmosphere, the existence of a very bright auroral band or streamer may mean an electrical current of unusually high intensity reckoned per unit of cross-section, but one having a comparatively small section. Thus the existence of visible aurora may mean only local concentration and no great total quantity of current. Thus the ultimate causes of aurora and magnetic disturbance may be the same, without any close parallelism being exhibited between the apparent intensities of the two phenomena.

§112. Two attempts were made to trace the possible interconnection of aurora and magnetic disturbance. The character of the magnetic curves was considered at all the times when aurora was noted, and a rough judgment passed. The magnetic trace was characterised as "quiet," "normal," "moderately disturbed," and "somewhat highly disturbed." These terms may be thus interpreted:—"Normal" means that I regarded the amount of disturbance as about average; "quiet" means that distinctly less than the average amount of disturbance existed; "moderately disturbed" means somewhat above the average amount of disturbance; and "somewhat highly disturbed" that the existence of more than usual disturbance obtruded itself even on casual inspection. The average amount of magnetic disturbance

varied with the season, and 1903 was decidedly more disturbed than 1902, so that nothing like an exact standard of disturbance could well be maintained.

The results were as follows :—

TABLE LXXIII.

Year.	Separate entries of aurora.		Magnetic condition at time.			
	Total number.	Number for which corresponding magnetic records existed.	Quiet.	Normal.	Moderately disturbed.	Somewhat highly disturbed.
1902 . . . . .	125	115	30	57	21	7
1903 . . . . .	250	232	34	102	58	38
Totals . . . . .	375	347	64	159	79	45
Percentages . . . . .		100	18	46	23	13

On a good many of the occasions when the curves were quiet the aurora is described as faint, or very faint, but this was not always the case. Thus, on May 31, 1903, a species of corona is described as visible at 4 p.m. (*see* Plate 13, "Physical Observations") having "intensity bright as it rose to the zenith." The magnetic curves were, however, unusually quiet at 4 p.m. and for some time afterwards. There was a minor disturbance about 3.30 p.m., but it had subsided before 4 p.m.

§113. The second attempt referred to above consisted in examining individual magnetic curves more minutely, to see whether anything special happened at the precise times when aurora was noted.

A judgment was passed as to whether a correspondence existed. Cases which, so to speak, seemed worth sending to a jury, were adjudicated as to whether the correspondence were "possible," "probable," or "apparent." These terms may be interpreted as follows :—

"Possible" correspondence means that whilst the average man would probably decide against a true correspondence, he would experience more or less hesitation in doing so. In the case of "probable" correspondence the verdict would naturally be favourable, but again with hesitation. In the case of "apparent" correspondence there could be little doubt that a marked magnetic movement occurred during the observed aurora.

The decisions reached were as follows, the numbers denoting days on some of which more than one correspondence was considered :—

Correspondence.		
Possible.	Probable.	Apparent.
7	7	11

§114. The cases of apparent correspondence are included in the following list. Details of the magnetic disturbances are given in parallel with the description of the auroras as given by Mr. BERNACCHI.

Directions are geographical unless the contrary is explicitly stated.

June 30, 1902.

At 9.27 p.m. faint aurora arc from Observation Hill to Crater Hill (*i.e.* its centre a little south of true east). Altitude  $15^{\circ}$  to  $18^{\circ}$ .

It (aurora) had completely disappeared at 9.32 p.m.

V rose to a maximum at about 9.30 p.m.; the increase during the previous 3 minutes was specially rapid, amounting to about  $20\gamma$ . In the course of about 5 minutes D increased  $18'$  and diminished  $27'$ , the turning-point answering to about 9.27 p.m. Synchronous with this was a sharp, but not large movement in H.

After 9.32 p.m. curves normal.

The evening of June 30 was fairly quiet magnetically, but there were at about 9.15 p.m. (when there is no record of aurora) sharp oscillations in D and H, very similar in character, though opposite in direction, to those recorded 12 minutes later, and these were accompanied by a small but sharp temporary depression in V. The general trend of V was upwards from 9.0 to 9.30 p.m., the total increment being about  $65\gamma$ .

September 19, 1902.

Midnight (0 a.m.). Faint aurora extending from N.E. to S.W.

There was a large oscillation on the H curve. A decrease of  $50\gamma$  was followed by a rise of  $60\gamma$ . The turning-point was at about 0.5 a.m., the double movement occupying about 50 minutes. D diminished about  $30'$  between 11.55 p.m. on 18th and 0.7 a.m. on the 19th. The V magnet was out of action.

The night of September 18-19 was on the whole rather quiet, but there was another oscillation in H very similar to and not much less than the above, with the turning-point at about 10.50 p.m. on the 18th. The observer remarks under the date September 19 that daylight was getting too bright for aurora to be visible, so that the above display was presumably more than usually intense.

May 28, 1903.

10.45 p.m. Aurora semi-arc emanating from below hill in N.W. by W. magnetic (*i.e.* about  $5^{\circ}$  north of true east) and terminating abruptly over Observation Hill, N.N.W. magnetic (*i.e.* about  $45^{\circ}$  east of true south), where altitude was  $20^{\circ}$ . Light very faint and diffused.

The H curve shows a marked oscillation, a decrease of  $45\gamma$  being followed by a slightly larger increase. The turning-point occurred about 10.47 p.m., the whole movement occupying about 50 minutes.

There was no noteworthy variation in either D or V, but the latter element showed a slight rise after 10.55 p.m.

May 29, 1903.

3.0 p.m. Continued display of aurora in the S. and S.E., low on horizon, from  $0^{\circ}$  to  $3^{\circ}$  in altitude. Low arcs rising close upon one another, sometimes as many as parts of four or five, the southern extremities only being complete. High rays occasionally shot towards the zenith. The darkness below the arcs was marked. Movement chiefly from E. to S. in the rays, but from 3.0 to 4.30 p.m. the whole display had shifted from S. to E.

A magnetic disturbance of the special type described in Chapter X was in progress. Between 2.45 and 3.5 p.m. D diminished  $20'$ , while H increased a little over  $40\gamma$ , V remaining practically constant; then in the course of the next 18 minutes D increased  $36'$ , H diminished about  $30\gamma$ , and V increased  $15\gamma$ .

By 3.40 p.m. the elements had returned to about the values they originally possessed and appeared normally quiet.

In this instance the auroral display seems to have continued after the special magnetic disturbance had ceased.

July 19, 1903.

An especially brilliant aurora suddenly appeared a few minutes after 4.0 p.m., in the shape of a curtain, or segment of an arc, extending from W. 20° N. to N.E. magnetic (8° N. of E. to 17° W. of S. true). There was more movement, both vertical and horizontal, than has yet been observed. The vertical movement of the whole display *en masse* was fairly rapid from S. towards the zenith, and the horizontal motion of the huge shafts of light at one time too rapid for the eye to follow . . . Altitude at first was about 10° at the extremities E. and W., and 20° in the centre, but this gradually rose to 50° and 60° in the centre. The brightest display was at about 4.10 to 4.15 p.m.; had almost entirely disappeared at 4.25 p.m. . . . During this special display a bright auroral glow showed up above the hills almost at right angles to the curtain. The display originated quite suddenly in the direction of Mount Discovery (*i.e.* nearly S.W.) and flashed across the sky towards Observation Hill (nearly S.E.) in a few seconds.

There was a prominent movement in V, consisting of an increase of about 240 $\gamma$ , commencing about 3.30 and culminating about 4.15 p.m. During the next 40 minutes there was a decrease of about 170 $\gamma$ . The increase in V was most rapid from 4.5 to 4.15 p.m. (*i.e.* when the aurora was brightest), the rise during the 10 minutes being about 125 $\gamma$ .

The most notable change in D consisted of two very rapid oscillations between 4.0 and 4.20 p.m. During the first, which occupied about 9 minutes, D increased 60' and returned to its original value. During the second oscillation, which followed immediately on the first, D increased 118' and then diminished fully 130'. The H trace was off the sheet, in the direction of force increasing, most of the time from 3.30 to 5.0 p.m. But some very rapid oscillations came on the sheet about 4.5 to 4.15 p.m.

July 21, 1903.

4.0 p.m. Auroral display in E.

A disturbance of the special type (though not very typical) was in progress. From 3.32 to 3.44 p.m. V fell about 5 $\gamma$  and then rose about 87 $\gamma$  in the course of the next 31 minutes. Between 4.15 and 4.55 p.m. V fell about 50 $\gamma$ . Between 3.32 and 4.15 p.m. the D magnet executed a to-and-fro movement, first diminishing nearly 60', and then returning to about its original value. The absolutely lowest value occurred about 3.57 p.m. H showed an increase of about 40 $\gamma$ , followed by a decrease; the maximum, which was off the sheet, occurred apparently about 4.10 p.m. In the case of both D and H there were minor oscillations, which somewhat obscured the phenomena near the turning-points.

July 27, 1903.

0 a.m. Aurora just above hills from S. to S.W. magnetic (approx. N.N.W. to N.N.E. true), altitude about 5°.

V, which had diminished about 80 $\gamma$  since 10.20 p.m. on the 26th, commenced to rise about 11.50 p.m., and during the next 45 minutes increased about 180 $\gamma$ . It then diminished rapidly for a few minutes, and then more slowly until nearly 2.0 a.m. on the 27th. H went beyond the limit of registration, in the direction of force diminishing, about 11.50 p.m. on the 26th, and continued so until 0.40 a.m. on the 27th. D went through a number of irregular oscillations, the extreme range between 11.45 p.m. on the 26th and 0.35 a.m. on the 27th exceeding 60'.



July 27, 1903 (continued).

2.0 a.m. Isolated patches of diffused aurora from N. to S.E., altitude  $10^{\circ}$  to  $30^{\circ}$ .

4.0 a.m. Streamers or rays from N. to S.E.; various heights, mean  $40^{\circ}$ .

The aurora was more or less visible all night, and confined principally to N.E.; average altitude  $20^{\circ}$ .

At about 9.45 p.m. an unusual form of aurora appeared. A band of light extended from due S. to due N, passing round through E. Breadth of band  $5^{\circ}$  and averaged  $12^{\circ}$  in altitude. Intensity fairly strong in N. . . . The display reached its maximum brilliancy at about 9.50 p.m., and had almost entirely disappeared at 10.10 p.m. A few arrow-like beams were visible here and there just above the band.

V, which had been falling rather markedly since 0.35 a.m., rose about  $20\gamma$  between 1.55 and 2.5 a.m., and then diminished. There were approximately equal to-and-fro movements in both D and H, the turning-points occurring at about 1.55 a.m. D first diminished about  $30'$  and then increased, while H diminished about  $20\gamma$  and then increased.

From about 3.35 to 4.25 a.m. there was a deep bay on the H curve; the turning-point, which answered to a minimum in H, occurred within a few minutes of 4.0 a.m., but was beyond the limits of registration.

The D curve was not specially disturbed at 4.0 a.m., but there were minor oscillations on the V curve.

Between 9.20 and 9.30 p.m. V increased about  $25\gamma$ , and then remained nearly stationary until about 9.42 p.m., when a further rapid rise ensued.

Between 9.42 and 9.57 p.m. the increase was about  $80\gamma$ . During the next 5 minutes V fell a little, and then was nearly steady until after 10.20 p.m.

There were sharp oscillations in D and H between 9.45 and 10.0 p.m., but of no great magnitude.

July 28, 1903.

2.0 a.m. Faint aurora diffused over the E., forming a narrow curtain and a few streamers scattered irregularly.

3.0 a.m. Fine display of aurora, involving the whole heavens from N.W. by E. to S. Nothing ever visible in S.W. Three fine compact curtains in the E., one above the other, height of uppermost approximately  $60^{\circ}$ . Three more curtains, more diffused, but bright and much folded, extended from N.W. to zenith, where there were two large bright luminous clouds. The rest of the area was filled with more or less isolated streamers, small or fragmentary curtains or clouds. All was constantly changing . . .

4.0 a.m. Only the remains of the above display visible . . .

About 2.0 a.m. there were small oscillations on the V trace. There was a deep bay on the D curve, the turning-point, which answered to a maximum, occurring about 1.45 a.m. Between that hour and 2.20 a.m. D diminished about  $70'$ . There was a considerable movement in the H trace, which remained beyond the limit of registration, in the direction of H diminishing, from 1.40 to 2.15 a.m.

Between 2.55 and 3.20 a.m. there were marked oscillations in V, there being on the whole a decrease of about  $30\gamma$ . Between 3.20 and 3.38 a.m. there was a very rapid increase, amounting to about  $110\gamma$ . The H trace went beyond the limit of registration in the direction of H diminishing about 3.15 a.m., but only for a few minutes. The change preceding this was very rapid.

August 13, 1903.

10.0 p.m. Fairly brilliant display, consisting of a complete arc, extending from N. to S., and two streamers. The highest point of the arc was due E., with an altitude of  $15^\circ$ . At its E.S.E. point it was distorted by a relatively more brilliant and wider zone of light with a streamer rising out of it to  $30^\circ$  altitude. An independent ray also rose to  $30^\circ$  altitude to the S.E., but did not quite reach to the arc. The breadth of the arc was between  $2^\circ$  and  $3^\circ$ , the lower edge more defined than the upper, but neither particularly definite. Very rapid movement and very rapidly changing in form.

By 10.10 p.m. the arc had completely disappeared and was replaced by streamers of irregular altitude and interrupted in their lengths. The streamers rose at various points where the arc had been, the extremes being at E.N.E. and S. by E. points, with two more in between. The altitude of the highest was  $40^\circ$ . This latter display was also very rapidly changing.

10.20 p.m. Diffused streamer from due N., spreading out fan-like to about  $30^\circ$  altitude, but one thin band from one side of the fan extending across the sky to the W.

10.45 p.m. No aurora visible.

At 11.10 p.m. fine arc in S., extending from N.W. magnetic to N.E. magnetic ( $17^\circ$  S. of E. to  $17^\circ$  W. of S.), altitude of apex  $25^\circ$ , and exactly in magnetic Meridian.

The N.E. (magnetic) extremity much the brightest and formed of vertical rays, while N.W. (magnetic) and centre were rather faint and about  $4^\circ$  in width. The whole display moved rapidly towards zenith and at the N.E. (magnetic) formed draped aurora of a greenish tint. . . .

A few isolated rays in N., altitude  $40^\circ$ . Shortly after a bright draped curtain appeared a little to E. of zenith, altitude  $80^\circ$ , and arc became very faint.

At 11.20 p.m. only a few faint cloud-like patches here and there were visible.

After 9.40 p.m. numerous oscillations appeared in the V trace. A little before 10.0 p.m. V began to increase rapidly. The maximum was reached about 10.18 p.m., the rise being most rapid during the last 6 minutes. The total increase since 9.30 p.m. was about  $70\gamma$ .

After 10.18 p.m. V remained nearly constant during 20 minutes.

There was a deep bay on the D curve from about 9.50 to 10.40 p.m. A decrease of about  $70'$  was followed by an equal increase, the turning-point answering to about 10.12 p.m.

The H curve showed a somewhat similar bay, but it appeared somewhat earlier in time.

The H trace was, however, beyond the lower limit of registration from about 9.45 to 10.25 p.m., so that the turning-point was not shown.

Between 11.0 and 11.30 p.m. the V trace showed a sharp double oscillation, the amplitude in each being about  $25\gamma$ . The sharpest turning-point, which answered to a maximum of V, occurred at about 11.14 p.m.

The adjacent minima, which were also clearly shown, were at about 11.9 and 11.25 p.m. respectively.

There were sharp peaks on the D and H curves at about 11.10 p.m., D increasing  $27'$  between 11.10 and 11.13 p.m. Another very rapid movement occurred between 11.16 and 11.25 p.m., when D fell about  $57'$ .

It will be observed that both after 10.0 p.m. and after 11.0 p.m., whilst there were notable magnetic changes synchronous with the brightest phases of the aurora, these were not more notable than the magnetic changes recorded after the auroral display had become faint.

*August 14, 1903.*

2.0 a.m. Very faint, but extensive, aurora. Patches scattered about asymmetrically from N. to S.S.W.

Between 1.57 and 2.12 a.m. V first fell 15 $\gamma$  and then rose 25 $\gamma$ . This was accompanied by a sharp oscillation in the H curve, consisting of a fall of 38 $\gamma$ , followed by a rise of 30 $\gamma$ . There was also a to-and-fro movement of fully 15' in D.

Subsequent to 1.30 a.m. there was a good deal of oscillation in all the curves during the whole forenoon, and some of the D and H changes were decidedly more striking than those specified above.

*August 26, 1903.*

From 7.0 to 7.50 p.m. brilliant aurora was observed. Started with rays showing up above the hills from N. (magnetic) all the way round to S. (magnetic) (28° E. of S. to 28° W. of N.). Some of these rays were exceptionally long, extending, in some cases, to an arc of 50° vertically. The display seemed to have no special form. All manner of sinuous evanescent streamers, arcs, &c., were observed.

At about 7.35 p.m. one streamer, or ray, about 1° in width, extended vertically above Observation Hill (a little to E. of S.E.) to about 83° in altitude. This is the longest ray we have observed. At 7.40 p.m. a winding streamer, or curtain, appeared in the "Gap" (or about E.S.E.) and extended to about 45° in altitude. This was the most brilliant part of the display and was about equal to a star of the 2nd magnitude.

At 7.50 p.m. the display had almost dispersed, but remained faint and very diffused, like a kind of light luminous mist for some time after.

There was a very large magnetic disturbance commencing about 6.46 p.m. To all appearance the first part was of the special type (Chapter X), but as the V magnet was out of action, this is not absolutely certain.

Between 6.46 and 7.35 p.m. the D and H magnets each executed a large to-and-fro movement, on which were superposed numerous smaller and very rapid oscillations.

Both curves got beyond the limit of registration in the direction of element diminishing, so that the time of the turning-point cannot be fixed exactly, but it was within a few minutes of 7.15 p.m. The to-and-fro movements in D exceeded 105' and 120' respectively. The to-and-fro movements in H were equal and fully 100 $\gamma$ . The rise to the maximum at 7.35 p.m. was very rapid, and after the maximum there were extremely rapid movements in the opposite direction, D falling 54' and H falling 45 $\gamma$  in about 1½ minutes of time.

Another way of putting the facts is that in the course of about 3 minutes—synchronous apparently with the existence of the very long auroral streamer—D rose and fell 54'.

After 7.37 p.m. there were oscillatory movements in D, but of a much less striking character. The H trace was highly oscillatory from 7.40 to 8.0 p.m.

## APPENDIX A.

Abstract of "Term Day" Observations at Christchurch Observatory, New Zealand, made and tabulated by Dr. C. COLERIDGE FARR and Mr. H. F. SKEY, and their discussion by Dr. C. CHREE, F.R.S.

§1. THE "Discovery," on her way to the Antarctic, called at New Zealand, and magnetic observations were made at the Observatory at Christchurch. Dr. C. COLERIDGE FARR, who was then Director of the Observatory, being anxious to utilise to the utmost the opportunities presented, arranged with Captain SCOTT and Mr. BERNACCHI for an extension of the programme of simultaneous magnetic observations laid down before the Expedition left England. The original programme specified the 1st and the 15th of each month as "term days," during which hourly readings should be taken of the magnetic elements at all co-operating stations. The programme further arranged that on each term day there should be a "term hour," during which the values of the magnetic elements should be determined at 20-second intervals.

On the first regular term day—February 1, 1902—the term hour was to be 0-1 a.m., G.M.T. On each successive term day the term hour was to be one hour later, so that on January 15, 1903, the twenty-fourth regular term day, the term hour arranged was 11-12 p.m., G.M.T. This completed the regular year, but four additional term days were proposed, viz. February 1 and 15 and March 1 and 15, 1903; the term hours arranged for these were respectively 0-1, 1-2, 2-3, and 3-4 a.m., G.M.T.

At observatories provided with self-recording instruments the readings were to be derived from the curves, and, to admit of their being read at 20-second intervals, it was intended that the drums carrying the photographic paper should be rotated more rapidly than usual, twelve times the usual rate being the speed commonly adopted. The extension of the programme thus arranged at Christchurch contemplated that the magnetograph drums should be "quick run" during the whole term day. By altering the position of the light after each revolution of the drum, six or eight hours' run were usually obtained on a single sheet, but the mere alteration of the light entailed the presence of an observer, and several times, in the absence of a second observer, Dr. FARR had to remain on duty during the whole 24 hours. Notwithstanding the difficulties encountered, the revised programme was actually carried out at Christchurch, quick runs being taken on 26 terms days from March 1, 1902, to March 15, 1903, inclusive. Some little trace was necessarily lost when the light was being moved and when fresh paper was being put on, and occasionally an hour or two's record is lacking, e.g. from 10 to 12 p.m., G.M.T., on September 15, 1902. Declination trace was lost for one whole day, November 15, 1902. Everything considered, however, the loss of trace is remarkably small.

The extended scheme proved impracticable in the Antarctic. Still, quick runs were taken during several hours of most term days. This was so far fortunate as a mistake had somehow crept into the Antarctic 'Manual,' which made each term hour 12 hours later than it should actually have been, and the observer, Mr. BERNACCHI—in the absence of any information to the contrary—naturally supposed the 'Manual' to be correct. Thanks to the extended programme, there were three term days on which the quick run made in the Antarctic covered at least a part of the real term hour, though on one of these occasions the part thus covered is but short.

§2. The original programme—which originated in Germany, but was approved by the Advisory Committee of the British Expedition—specified certain forms on which term-hour observations should be entered. Thus, taking the case of the Horizontal Force, the actual curve readings were to occupy one column, the converted values a second, the temperature corrections a third, the last column giving the finally corrected values of the ordinates in absolute measure C.G.S. The absolute value answering to zero ordinate, with particulars of the scale values and of the formula for the temperature corrections, were to be given on a separate page. The form for each term hour provided for 180 entries under each of 10 separate columns. Dr. C. C. FARR and his successor at Christchurch, Mr. H. F. SKEY, applied the

original scheme to the whole of the quick runs, with this exception that the curves were read at 1-minute intervals only during a considerable part of the term day, readings at 20-second intervals being limited to part of the day, including always the true term hour.

After the return of the German and British Expeditions the German authorities suggested that the curves should all be copied on squared paper and published in this form, so that anyone could read off for himself the absolute value answering to any specified instant of time. Photographic copies were thus taken at Christchurch of all the quick-run curves.

The Christchurch material for term days, due to the combined efforts of Dr. FARR and Mr. SKEY, was thus of a most comprehensive and voluminous character.

In advising as to what should be published I was guided largely by the following considerations:— It was obvious that to publish the tables in full and to reproduce all the curves would occupy an amount of space and entail an expenditure which it was unreasonable to expect the Royal Society to sanction unless the results were likely to prove of extreme value. Now, it so happened that the term hours were unusually badly adapted for securing the objects ordinarily aimed at in simultaneous observations at short intervals of time.

The scheme was presumably due in considerable measure to the success attending a similar scheme proposed some years earlier by the late Dr. ESCHENHAGEN, of Potsdam Observatory. This earlier scheme applied, however, to only two or three hours, and, on one of these, as it happened, there was a well-marked magnetic disturbance. The simultaneous observations at the co-operating stations enabled this disturbance to be followed in minute detail by Dr. A. SCHMIDT, who succeeded Dr. ESCHENHAGEN at Potsdam. But of the term days observed during 1902–3 at Christchurch there was not one which presented any noteworthy disturbance. This will be readily seen on consulting the tables of hourly values published in "Physical Observations," pp. 160–179. Referring to the Declination results given there for Christchurch, on p. 177, it will be seen that the daily range never exceeded  $13' \cdot 1$ , and on eight days it was actually under  $5'$ .

For the study of a disturbance of moderate size, whose phases develop smartly, quick-run curves have some marked advantages, but when magnetic changes are small and develop slowly, the gradient in quick-run curves is so slight that they look uncommonly like straight lines, and really disclose less to the eye than ordinary slow-run curves. This will be readily realised after inspection of the curves in Plate III, which are fairly representative of term-hour conditions at Christchurch.

Taking these facts into consideration, I decided that the publication of the tabulations made at Christchurch—tabulations representing an immense amount of labour on the part of Dr. FARR and Mr. SKEY—was likely to be more useful than reproduction of the curves.

§3. Coming now to the tabulations, it was obvious that what we may call the "raw material" in the international forms—consisting of the uncorrected curve readings and the corrections—might be omitted without seriously impairing the value of the results. The raw material is necessary if one's object is to check the accuracy of the results, but it is usual to assume such checking to have been adequately performed by the observers. Another abbreviation was obviously possible, which had indeed been to some extent adopted in the sheets as received from Christchurch.

The magnetic changes were usually so slow and regular that for an element to change appreciably occupied several minutes, sometimes even hours. Thus in one outstanding case the Declination showed no change as large as  $0' \cdot 1$ , the unit adopted, between 13h. 41m. and 16h. 3m. In this instance the international form provided for the repetition of the same figure—even on the basis of 1-minute observations—142 times. Such repetitions are avoided by the method adopted here. Put briefly, the method consists in recording the value of an element only at the time when a change took place. Supposing, for instance, the Declination to remain at  $16^{\circ} 12' \cdot 0$  from 1h. 30m. to 1h. 39m., but to be  $16^{\circ} 12' \cdot 1$  at 1h. 40m., it is sufficient to record the values at 1h. 30m. and 1h. 40m., it being laid down that the absence of an entry signifies no change. Even as thus reduced, the material appeared to require further reduction. Accordingly, selecting a few representative term days, I investigated from which of the three elements—Declination, Horizontal Force, and Vertical Force—results of most value were likely to be derived. It was at once obvious that the Vertical-Force data promised to be the least valuable.

Referring to the hourly values of this element given on p. 179 of the "Physical Observations," it will be noticed that a considerable number of discontinuities presented themselves, while the daily ranges were exceedingly small. The former phenomenon throws some doubt on the smooth working of the instrument, and the latter indicates that, even if the data were as trustworthy as those for the other two elements, they would form a less promising field of investigation.

The choice between Declination and Horizontal Force was more difficult. The examination, however, of the results from the few representative days pointed to the conclusion—fully confirmed by subsequent investigation—that the diurnal variation of Declination is decidedly more regular at Christchurch than that of Horizontal Force, and, accordingly, that it is the latter element whose changes promise the greatest return to minute examination. Accordingly, I recommended that publication of complete details of the variation throughout the whole duration of term days should be confined to Horizontal Force (pp. 204-228), and that in the case of the Declination (pp. 229-230) full details should be given only for the term hours. The Vertical-Force changes are not individually shown at all. Though details of the variations of Declination and Vertical Force are published only partially, or not at all, these variations were carefully studied and tabulated and a number of conclusions have been deduced.

CHRISTCHURCH TERM-DAY OBSERVATIONS.

CHANGES of Christchurch Horizontal Force. March 1, 1902.

Value of H.	Begins at—	Value of H.	Begins at—	Value of H.	Begins at—	Value of H.	Begins at—	Value of H.	Begins at—
	h. m.		h. m.		h. m.		h. m.		h. m.
22672	0 0	22704	3 42	22707	6 33	22707	10 38	22703	18 21
71	3	03	45	09	34	06	39	02	35
72	4	04	55	11	35	07	40	01	43
71	7	08	56	08	36	10	41		
72	8	07	3 57	11	40	07	42	02	49
73	12	06	4 1	12	42	09	43	01	18 54
74	15	04	2	11	44	07	44	700	19 8
75	22	05	13	10	45	09	46	699	13
74	30	06	16	09	49	07	48	700	16
73	31	05	21	10	50	08	49	22699	20
72	31 3	07	22	09	51	07	51	98	22
74	32	05	23	08	52	08	53	97	31
75	34	06	25	11	54	07	10 54	96	39
74	37	07	26	12	55	06	11 4	95	43
73	38	08	30	11	6 57	07	6	94	47
74	40	07	34	12	7 0	07	8	93	19 51
73	41	07	35	13	1			92	20 1
72	42			14	5	06	12	91	9
73	49	07	41	12	6	05	24	90	13
74	51	08	48	08	7	04	27	90	14
75	0 54	09	49	06	8	05	29		
76	1 1	10	51	05	9	06	44	88	20
77	5	09	53	04	10	07	11 54	87	29
79	11	10	54	06	12	08	12 2	86	32
80	15	09	55	07	13	10	22	85	35
80	31	08	4 57	08	14	11	23	84	37
		09	5 0	09	15	10	30	83	39
84	37	08	2	10	16	09	31	82	48
85	44	09	4	11	17	07	32	81	51
86	52	10	7	12	22	07	36	80	56
87	54	11	8	13	27			79	20 59
88	56	10	13	12	32	08	52	78	21 5
87	57	09	14	13	43	09	57	77	9
88	1 59	10	16	14	46	08	12 59	76	12
89	2 1	09	17	13	7 50	09	13 5	75	15
90	6 3	10	19	14	8 2	08	11	74	22
89	7 6	09	22			07	12	73	28
90	13	10	23	16	9	06	13	72	36
91	15	09	28	15	11	07	19	71	38
92	16	08	29	14	20	06	26	72	40
93	20	09	30	13	21	07	51	71	41
92	25	08	31	14	31	06	13 58	71	42
93	28 3	09	34	15	33	06	14 11		
94	31 6	10	37	14	34			70	21 53
95	39	11	40	13	36	07	16	69	22 1
96	41 6	12	42	14	45	06	20	68	9
95	47	14	44	15	47	07	24	67	24
94	50	13	46	14	52	06	40	68	29
95	51 6	12	47	13	53	07	14 55	67	32
96	53	11	48	12	8 58	06	15 1	68	34
95	55	12	49	13	9 10	05	13	69	38
96	57	11	50	12	18	04	36	68	39
97	2 58 3	12	52	13	19	03	40	69	53
98	3 0	10	54	14	20			68	54
99	2	09	55	13	21	04	45	69	56
98	7	10	57	12	22	03	48	68	58
99	9	11	5 58	13	26	04	15 51	69	22 59
699	11	10	6 0	14	31	03	16 9	68	23 0
		09	1	14	32	04	19	69	1
700	16	08	3			03	20	70	9
699	17	07	4	12	37	04	21	69	14
700	21	09	6	13	42	05	22		
01	22	10	9	12	44	04	23	70	19
02	24	11	10	11	46	05	25	71	31
701	25	09	11	10	48	06	28	72	39
699	26	10	12	09	52	05	16 36	73	44
99	26 6	11	13	10	9 53	06	17 13	74	51
698	27	10	14	09	10 0	05	15	73	52
700	28	09	15	10	8	05	18	74	54
698	29	10	16	09	11			73	58
704	30	10	17	08	13	05	35	74	23 59
06	31			07	15	06	36	22674	24 0
07	33	07	29	06	23	05	41		
05	38	06	30	04	31	06	17 50		
04	39	04	31	05	32	05	18 12		
22703	3 40	22705	6 32	22706	10 35	22704	18 18		

CHANGES of Christchurch Horizontal Force. March 15, 1902.

Value of H.	Begins at—	Value of H.	Begins at—	Value of H.	Begins at—	Value of H.	Begins at—	Value of H.	Begins at—
	h. m.		h. m.		h. m.		h. m.		h. m.
22676	0 0	22712	4 0		—	22713	10 57	22715	17 1
75	9	13	2	22720	7 51	14	10 59	16	19
74	20	12	3	18	52	15	11 1	16	25
75	21	14	8	17	53	14	4	—	—
76	28	15	10	16	54	13	7	16	17 29
75	32	14	16	15	55	12	10	15	18 26
76	35	15	18	13	56	13	15	16	31
75	38	16	19	12	7 57	12	23	17	49
76	43	15	20	13	8 2	11	36	18	55
77	50	16	23	14	4	12	11 54	19	18 56
78	55	17	31	15	8	13	12 18	19	19 2
79	57	17	39	14	11	13	26	—	—
78	0 59	—	—	11	12	—	—	17	13
79	1 1	19	55	13	13	13	30	16	20
80	6	18	4 58	17	14	14	44	15	41
81	18	19	5 1	20	15	13	47	14	46
82	21	20	4	21	16	12	12 49	13	57
83	23	19	7	22	17	11	13 4	12	19 59
—	—	18	11	21	20	10	6	11	20 6
83	26	17	13	20	21	11	7	10	14
82	27	16	29	18	22	12	8	09	18
81	28	17	32	19	23	13	33	08	23
82	31	18	38	18	27	14	47	07	30
83	33	17	44	14	28	15	49	06	39
84	34	16	46	12	29	14	13 56	05	44
85	37	15	48	11	33	13	14 0	04	46
86	1 59	16	49	10	34	14	6	04	47
87	2 1 6	17	50	08	35	—	—	—	—
86	2	16	5 59	07	40	12	18	03	49
87	6	17	6 0	08	45	13	26	02	20 58
88	9	16	7	09	50	12	29	01	21 2
87	11	18	8	08	8 55	11	36	700	6
88	16	17	9	09	9 1	10	37	699	7
89	19	18	10	08	4	08	38	98	8
90	23	17	12	09	5	07	41	98	20
91	25	16	13	10	6	08	42	—	—
92	27	16	14	09	8	09	45	98	24
93	32	—	—	10	11	10	50	97	31
93	2 33	17	17	—	—	11	55	96	34
—	—	18	21	08	9 21	12	14 58	95	39
699	3 0	17	28	09	10 18	11	15 12	94	51
700	2	18	29	08	20	10	14	93	21 53
01	11	17	33	09	21	09	15	94	22 0
02	12 6	18	35	08	22	10	18	93	2
03	16	17	40	07	23	11	25	92	11
04	19	18	43	08	31	12	30	91	29
05	23 3	17	6 53	09	36	13	39	91	22 30
06	25 3	18	7 0	08	37	14	44	—	—
07	27 6	17	13	09	40	14	49	90	23 5
08	32	18	14	08	45	—	—	91	7
09	39 3	17	17	08	46	14	15 54	92	22
10	41 6	19	27	—	—	15	16 24	91	28
11	44 6	21	28	09	49	16	25	91	31
10	46	22	30	08	50	15	30	—	—
11	49 3	21	37	09	51	14	32	92	40
12	50 6	20	38	11	54	13	37	93	23 41
22713	3 55	22720	7 47	22712	10 55	22714	16 47	22693	24 0



CHRISTCHURCH TERM-DAY OBSERVATIONS.

CHANGES of Christchurch Horizontal Force. April 1, 1902.

Value of H.	Begins at—	Value of H.	Begins at—	Value of H.	Begins at—	Value of H.	Begins at—	Value of H.	Begins at—
·22678	h. m. 0 6	·22700	h. m. 4 0	·22690	h. m. 7 6	·22688	h. m. 11 51	·22698	h. m. 17 16
79	8	01	7	89	20	89	53	99	19
80	10	00	7·3	90	21	91	54	98	20
81	12	01	10	91	22	95	55	99	37
80	24	02	12·3	90	23	97	56	98	45
79	25	01	14·3	89	27	699	57	99	17 58
80	33	00	15·3	88	28	701	58	98	18 31
81	35	01	17	87	29	04	11 59	98	35
82	40	02	19·3	86	30	05	12 1	—	—
83	44	03	22·6	85	31	04	5	97	45
84	47	04	24	84	32	06	6	98	18 51
83	49	05	24·6	83	34	05	7	97	19 0
84	52	04	25	82	37	04	9	96	2
85	0 58	03	26·6	83	39	03	11	97	14
84	1 0	02	32	82	41	02	14	96	16
85	4	03	35·3	83	42	00	16	95	28
84	5	04	38	82	45	701	18	94	43
85	6	03	4 39·6	84	46	699	19	93	19 51
86	16	04	5	85	49	701	20	94	20 6
87	20	01	2	84	51	699	21	93	16
88	29	700	3	85	52	700	22	92	19
—	—	699	4	86	59	699	23	92	22
88	32	98	5	85	8 1	700	25	—	—
89	33	97	6	86	3	699	26	92	25
90	44	95	7	87	5	700	33	91	31
91	49	94	9	88	7	01	36	90	33
92	51	93	10	89	11	00	37	89	44
93	55	94	12	90	17	01	38	88	51
94	1 59	95	14	90	22	700	39	87	53
95	2 2	96	19	—	—	699	48	86	20 58
96	13	97	20	90	8 32	98	51	85	21 4
97	15	98	23	89	9 8	97	54	84	8
98	21	99	25	88	14	96	55	83	14
699	23	98	26	87	15	95	12 57	82	16
700	45	97	28	86	17	94	13 7	81	19
01	51	97	30	87	20	93	11	80	28
03	54	—	—	86	21	92	20	79	33
02	56	97	34	87	24	91	25	78	36
03	2 57	99	35	88	26	—	—	79	37
02	3 0	98	44	87	28	90	38	78	39
02	4	97	45	88	29	91	48	77	43
—	—	98	46	89	33	90	49	76	21 56
04	7	97	47	87	37	91	13 58	76	22 3
05	13	98	48	88	38	92	14 2	—	—
06	15	97	50	87	42	93	14	76	7
07	16	98	51	86	47	92	19	75	13
06	17	99	56	85	51	93	23	74	19
07	19	98	5 59	84	53	92	29	73	22
06	20	97	6 1	83	9 57	93	34	72	27
05	21	96	4	82	10 2	94	14 47	71	48
04	22	95	10	81	7	95	15 17	70	22 57
03	23	96	35	—	—	—	—	71	23 3
02	24	97	38	82	11	95	23	72	8
01	25	97	40	83	15	94	26	71	10
700	26	—	—	82	30	95	35	72	13
699	27	96	49	81	35	96	15 56	73	19
700	31	95	50	82	51	95	16 6	72	25
01	35	99	54	83	10 55	96	14	73	27
02	40	96	55	84	11 7	97	30	74	32
02	41	95	6 56	85	21	97	16 57	73	35
—	—	93	7 1	86	25	—	—	73	42
01	54	92	2	85	41	98	17 0	—	—
00	55	94	3	85	46	98	5	73	45
·22700	3 58	98	4	—	—	—	—	74	23 59
—	—	·22691	7 5	·22687	11 50	·22699	17 13	·22675	24 0

CHANGES of Christchurch Horizontal Force. April 15, 1902.

Value of H.	Begins at—	Value of H.	Begins at—	Value of H.	Begins at—	Value of H.	Begins at—	Value of H.	Begins at—
	h. m.		h. m.		h. m.		h. m.		h. m.
·22684	0 0	·22694	4 48	·22696	8 0	·22696	13 59	·22698	20 0
84	8	92	57	96	1	97	14 0	97	18
	—	91	58		—	98	21	96	37
84	22	90	4 59	96	3	98	31	95	43
83	31	89	5 0	97	6		—	94	20 59
84	43	90	4	96	26	98	38	94	21 4
85	0 50	91	4 ·6	95	8 37	699	41		—
86	1 8	92	9	96	9 4	700	49	93	9
87	15	93	23	97	14	699	54	92	27
88	19	92	23 ·3	97	34	98	14 58	91	30
89	25	93	23 ·6		—	699	15 16	90	33
89	35	94	34 ·3	97	44	700	19	89	36
	—	93	38 ·6	96	9 52	699	28	88	21 48
88	38	92	39 ·6	95	10 0	98	15 39	87	22 11
89	1 59	91	44 ·6	96	11	99	16 3	86	17
90	2 10	92	45 ·3	97	10 37	98	6	85	29
91	13	93	48	96	11 12	99	9	84	40
92	17	94	5 50 ·6	96	15	99	13		—
91	25	95	6 5		—		—	85	46
90	31	94	6	96	26	699	16 15	84	22 54
91	35	95	15	95	11 49	700	17 2	83	23 6
92	41	94	17	94	12 12	01	14	82	15
93	2 45		—	95	14	00	17 31	81	17
94	3 0	94	22	96	35	01	18 5	82	18
94	6	94	23	96	52	700	17	81	22
	—		—		—	699	26	80	25
94	9	94	31	95	55	98	29	79	28
93	20	95	35	96	12 56	99	32	80	31
94	3 44	93	44 ·3	95	13 4	98	18 45	81	39
95	4 23	94	45	94	18	99	19 10	80	40
94	27	95	54	95	24	99	20	79	23 44
95	35	94	55	96	46		—	·22679	24 0
94	37	95	6 56	95	47	99	31		
·22695	4 42	96	7 28	96	48	98	33		
	—	·22697	7 34	·22697	13 52	·22697	19 54		

CHRISTCHURCH TERM-DAY OBSERVATIONS.

CHANGES of Christchurch Horizontal Force. May 1, 1902.

Value of H.	Begins at—	Value of H.	Begins at—	Value of H.	Begins at—	Value of H.	Begins at—	Value of H.	Begins at—
	h. m.		h. m.		h. m.		h. m.		h. m.
·22697	0 0	·22703	4 17	·22708	7 38 ·5	·22706	10 57	·22709	19 40
96	1	04	19	09	39	05	11 17	08	20 4
95	5	05	31	10	40	05	56	09	5
96	6		—	11	41		—	08	8
95	7	06	37	10	43 ·6	05	11 59	07	15
94	10	07	39	11	44	06	12 12	08	21
93	17	06	43	11	45	05	12 57	07	22
92	23	07	50		—	05	13 18	06	43
91	34	06	55	11	47		—	06	55
90	47	07	4 56	10	53	06	13 26		—
91	48	08	5 0	11	55	07	14 11	06	20 50
92	50	07	5 ·6	10	56	06	28	05	21 4
91	54	08	6	09	8 3	05	43	04	9
92	0 55	07	6 ·6	10	4	06	47	03	14
91	1 4	08	7	09	5	05	14 48	02	15
92	20	06	9	08	11	04	15 0	01	37
92	24	07	10	09	13		—	00	48
	—	08	11	08	14	04	15 3	01	49
92	26	07	12	07	15	05	16 18	700	50
91	34	06	15	08	16	04	19	699	21 58
92	1 43	07	16	07	17	05	22	98	22 3
93	2 1	08	18	08	18	05	24	97	7
92	9	09	19	07	19		—	97	24
93	13	08	21	08	43	04	16 29		—
92	16	09	27	08	48	03	17 3	95	32
93	19	08	32		—	02	4	94	40
94	46	09	40	07	8 54	01	8	93	43
93	47	10	5 43	06	9 3	02	18	92	55
94	48	09	6 27 ·3	07	20	03	21	91	22 59
94	57	10	7 0	06	26	04	24	90	23 0 ·3
	—	09	1	05	9 46	05	40	91	0 ·6
94	2 59	08	7	07	10 26	05	48	90	1
95	3 0	09	10	08	34		—	89	5
96	5	10	24	10	34 ·6	06	17 59	88	8
97	20	09	25	08	35	07	18 18	87	23
96	21	10	27	07	36	08	50	86	28
97	23	09	33	08	38	09	18 54	85	32
98	39	10	34	09	39	08	19 21	84	34
699	44	09	35	08	43	08	26	83	23 45
700	50	10	36	07	47		—	·22683	24 0
01	3 53	11	37 ·6	08	48	07	29		
·22702	4 10	·22709	7 38	·22707	10 51	·22708	19 36		

CHANGES of Christchurch Horizontal Force. May 15, 1902.

Value of H.	Begins at—	Value of H.	Begins at—	Value of H.	Begins at—	Value of H.	Begins at—	Value of H.	Begins at—
	h. m.		h. m.		h. m.		h. m.		h. m.
.22690	0 0	.22693	2 36	.22705	4 49	.22705	9 58	.22709	20 25
89	13	92	37	04	51	04	10 35		
88	22	93	38	05	53	05	10 41	08	27
87	29	94	40	04	4 59	06	11 0	07	30
86	34	93	41	03	5 5	06	31	06	37
85	0 40	94	42	04	6			05	20 59
86	1 1	93	43	03	7	06	34	04	21 16
85	5	94	44	04	9	05	48	03	47
86	15	95	47	03	18	06	52	02	21 52
85	17	94	49	04	21	07	56	02	22 1
86	19	95	51	05	45	06	11 59		
85	20	95	2 52	05	52	06	12 51	01	13
85	21							02	23
		93	3 2	05	5 54	06	12 59	01	28
86	31	92	3	04	6 24	06	14 25	00	32
87	35	92	4	04	53			01	34
88	43					06	14 28	00	35
89	45	92	10	04	6 56	06	15 58	01	36
88	46	93	12	05	7 2 6			00	37
89	48	92	13	04	3	06	16 0	01	45
90	1 52	91	19	05	8 3	07	41	700	22 47
91	2 0	92	30	04	18 6	06	16 47	699	23 3
92	3	91	33	05	21 3	05	17 0	98	24
91	7	92	34	04	25 3	06	6	97	33
92	14	93	36	05	35 3	06	18	97	37
91	15	94	37	04	40 3				
92	23	95	42	05	53 3	05	29	97	39
91	26	96	49	04	7 54 6	06	43	96	46
92	27	97	55	04	8 23	05	51	95	52
93	30	98	3 59			06	17 53	96	53
92	31 6	699	4 4	05	31	07	18 30	95	56
93	32 5	700	9	06	8 56	08	44	96	23 57
92	33	00	13	05	9 2	08	55	.22695	24 0
94	34			06	28				
92	34 6	02	23	05	39	07	18 59		
93	35	03	34	.22705	9 55	08	19 53		
.22694	2 35 5	.22704	4 48			.22709	20 5		

## CHRISTCHURCH TERM-DAY OBSERVATIONS.

CHANGES of Christchurch Horizontal Force. June 1, 1902.

Value of H.	Begins at—	Value of H.	Begins at—	Value of H.	Begins at—	Value of H.	Begins at—	Value of H.	Begins at—
	h. m.		h. m.		h. m.		h. m.		h. m.
·22693	0 0	·22687	2 50	·22697	5 58	·22687	8 31	·22701	16 37
92	8	88	51	98	6 5	88	32	01	47
91	13	87	52	97	6	89	34		—
90	18	86	54	97	7	88	8 48 <sup>·3</sup>	01	50
89	24	85	55		—	89	9 1	02	16 54
90	26	86	57	98	9		—	01	17 0
89	27	87	58	97	24	89	5	02	17 9
88	34	88	2 59	96	27	90	11	02	18 15
89	36	87	3 1	95	29	89	12		—
88	37	88	2	94	30	90	29	02	28
89	38	87	3	·93	33	91	32	03	30
88	39	86	5	92	34	92	33	04	42
87	40		—	91	35	93	36	03	43
86	42	86	7	92	42	92	46	02	50
85	43	87	9	91	44	93	9 58	01	18 53
84	45	86	10	92	45	94	10 0	00	19 0
83	50	87	12	93	46	95	12	01	19
84	51	85	14	94	6 56	96	15	02	32
83	0 57	87	16	93	7 0	95	35	01	44
84	1 12	88	21	94	14	95	36	02	48
83	13	87	24	95	14 <sup>·5</sup>		—	03	19 57
82	17	88	27	93	15	95	38	03	20 3
83	19	89	31	95	15 <sup>·3</sup>	94	39		—
84	28	88	34	94	16	93	10 54	03	6
83	30	89	35	95	17	94	11 3	04	9
84	31	88	36	94	18	93	4	03	25
84	32	87	39	95	24	92	6	02	54
	—	88	45	94	27	93	19	03	20 58
85	34	89	3 50	95	31	94	24	02	21 3
84	36	90	4 3	94	34	95	32	03	13
83	40	91	10	94	38	94	11 35	03	35
84	41	92	16		—	94	12 8		—
85	1 55	93	18	95	41		—	03	37
84	2 9	94	23	96	43	94	11	04	51
85	11	94	34	97	44	95	21	05	21 57
84	12		—	96	45	96	23	04	22 0
85	13	97	40	95	52	97	25	03	10
86	15	98	50	94	54	98	12 28	02	27
87	17	97	51	93	57	99	13 27	01	35
88	18	98	4 55	92	7 58	699	38	700	22 44
87	21	699	5 16	91	8 0 <sup>·3</sup>		—	699	23 1
88	22	700	19	90	1	700	49	699	2
87	23	01	20	89	2 <sup>·6</sup>	699	13 57		—
86	28	02	22	90	9 <sup>·6</sup>	700	14 1	700	9
87	39	01	24	89	13 <sup>·6</sup>	01	12	699	13
88	43	02	26	88	18 <sup>·6</sup>	02	14 18	98	18
89	45	01	51	87	22		—	97	28
88	46	700	53	86	23 <sup>·3</sup>	02	15 19	96	45
89	47	699	54	85	25 <sup>·6</sup>	01	16 16	97	23 53
·22688	2 48	·22698	5 56	·22686	8 27 <sup>·6</sup>	·22702	16 36	·22697	24 0

CHRISTCHURCH TERM-DAY OBSERVATIONS.

CHANGES of Christchurch Horizontal Force. June 15, 1902.

Value of H.	Begins at—	Value of H.	Begins at—	Value of H.	Begins at—	Value of H.	Begins at—	Value of H.	Begins at—
·22694	h. m. 0 0	·22703	h. m. 7 3	·22706	h. m. 12 20	·22704	h. m. 15 3	·22709	h. m. 19 33
93	12	04	7	05	21	03	4	10	34
92	26	03	8	04	23	02	9	09	39
91	36	02	13	702	24	01	11	08	40
90	43	03	15	699	25	00	14	09	41
89	44	04	38	98	26	01	18	10	45
90	46		—	96	27	02	20	09	46
89	51	03	40	94	28	01	26	10	48
90	53	04	41	95	30	02	29	09	49
89	0 59	05	42	96	31	01	35	08	50
88	1 23	04	43	698	32	700	42	09	52
88	31	03	7 44	702	33	699	43	08	19 57
	—	02	8 16	06	34	700	48	09	20 9
89	33	03	19	07	36	01	52	10	17
88	35	02	22	10	37	00	53	08	19
89	1 36	03	30	08	39	701	53·5	09	20
90	2 14	02	36	10	40	699	54	10	21
89	18	03	38	08	41	700	54·3	09	24
90	22	03	49	07	42	01	15 55	10	25
89	33		—	06	47	02	16 3	09	27
90	35	03	8 54	07	49	03	18	10	29
91	48	04	9 45·6	06	50	03	21	09	34
90	52	05	53·6	08	51		—	10	37
91	53	04	54·6	07	52	03	24	09	38
92	2 56	03	9 59·3	08	54	04	41	10	39
91	3 0	04	10 17	07	55	05	48	09	41
92	1	04	20	08	12 59	06	16 59	10	44
92	6		—	07	13 3	04	17 4	10	52
	—	03	23	06	4	03	5		—
93	9	02	26	07	8	04	8	09	55
94	24	01	27	10	10	05	9	10	56
95	28	00	34	11	12	04	13	09	20 57
96	30	01	38	12	13	03	15	08	21 17
97	32	00	40	11	15	02	34	07	34
98	37	01	50	10	17	01	37	08	47
97	38	02	52	08	21	02	38	07	48
96	39	03	53	06	22	01	42	06	50
97	40	05	55	702	23	02	43	07	51
98	47	06	57	694	24	01	48	08	54
97	50	05	10 59	92	24·16	01	50	09	57
98	51	04	11 1		—		—	08	21 59
99	55	03	2	90	29	03	17 57	07	22 2
98	56	02	5	93	30	04	18 0	08	25
99	58	03	12	96	31	05	4	07	26
98	3 59	04	17	97	32	06	6	07	27
699	4 1	05	20	698	33	05	9		—
700	11	06	23	700	34	06	11	07	35
01	15	07	24	02	35	07	17	06	42
00	17	08	26	03	36	08	34	07	43
01	19	10	27	04	39	07	35	06	48
00	20	11	29	05	40	08	36	07	22 59
01	21	10	30	04	45	07	39	06	23 0
02	25	09	33	03	48	08	43	07	3
02	40	07	34	02	51	09	44	06	5
	—	06	35	01	53	10	47	05	7
02	4 49	04	36	02	13 56	09	48	04	11
03	5 5	03	38	03	14 7	10	49	03	17
02	6	02	39	02	14	08	50	02	31
03	12	03	40	01	15	07	52	01	32
02	24	04	45	700	16	06	53	02	33
03	28	03	47	699	17	07	18 56	01	38
02	31	04	49	700	21	08	19 0	00	40
03	39	03	51	01	22	09	1	01	41
02	5 57		—	700	28	10	3	00	42
02	6 8	04	53	699	30	09	7	01	43
	—	03	11 55	700	38	08	8	700	45
03	11	04	12 1	699	39	09	13	699	48
04	32	05	3	98	42	10	16	701	49
03	33	06	10	699	43	09	19	02	51
04	41	05	11	700	47	10	24	01	54
03	44	04	12	699	55		—	02	57
04	48	05	13	700	14 58	10	26	01	23 58
03	49	06	15	·26701	15 0	09	27	·22701	24 0
·22704	6 59	·22707	12 16		—	·22710	19 28		

## CHRISTCHURCH TERM-DAY OBSERVATIONS.

## CHANGES of Christchurch Horizontal Force. July 1, 1902.

Value of H.	Begins at—	Value of H.	Begins at—	Value of H.	Begins at—	Value of H.	Begins at—	Value of H.	Begins at—
	h. m.		h. m.		h. m.		h. m.		h. m.
·22697	0 0	·22698	3 52	·22704	8 15	·22708	13 17	·22709	18 26
96	6	97	53	04	31	09	20	09	—
97	7		—		—	08	28	09	18 51
96	11	96	3 58	04	36	07	33	09	19 1
97	15	97	4 1	03	8 44	06	38		—
96	17	98	2	04	9 6	07	40	09	3
97	32	699	5	03	15	06	41	10	3 $\frac{1}{2}$
98	39	700	19	04	26	08	42	09	4
97	44	01	26	03	33	07	44	10	34
97	50	02	31	02	38	08	46	09	36
	—	03	35	03	49	09	47	10	19 39
98	0 52	04	40	02	53	08	48	11	20 15
97	1 17	05	46	01	9 55	09	50	12	25
96	25	06	58	00	10 15·3	08	56	12	32
95	31	05	4 59	01	16·3	09	57		—
94	46	04	5 17	00	28·3	08	13 58	12	34
93	52	04	23	01	31	07	14 5	13	41
92	1 54		—	02	39·3	06	14	12	53
91	2 1	04	25	01	39·6	07	16	13	20 59
91	26	05	5 38	02	40·6	06	18	12	21 26
	—		—	01	48	05	23	11	30
92	28		—	02	10 52·6	06	31	10	32
91	32	04	6 0	01	11 0	06	36	09	44
92	36	03	46	02	5		—	08	21 57
91	41	04	47	01	15	06	38	07	22 4
92	2 47	02	49	02	16	05	14 50	07	7
91	3 0		—	02	28	04	15 16		—
92	2	02	51		—	05	26	06	14
91	3	03	55	04	30	04	53	05	22
92	6	02	6 57	03	31	05	15 58	04	31
93	9	01	7 0	02	47	05	16 2	03	22 58
94	15	00	4	01	11 58		—	02	23 0
95	20	01	12	02	12 3	05	4	01	8
94	22	02	14	03	16	04	6	00	20
93	25	03	19	02	24	05	16 8	700	27
94	27	02	24	01	12 29	06	17 0		—
93	31	01	26	03	13 0	05	8	699	29
94	33	02	33		—	06	17	98	32
95	35	01	36	04	10	06	32	96	40
96	39	02	43	05	14		—	95	23 49
97	47	01	44	07	15	07	40	·22694	24 0
98	50	02	45	06	15·5	08	17 53		
·22697	3 51	·22703	7 54	·22707	13 16	·22709	18 19		

CHANGES of Christchurch Horizontal Force. July 15, 1902.

Value of H.	Begins at—	Value of H.	Begins at—	Value of H.	Begins at—	Value of H.	Begins at—	Value of H.	Begins at—
	h. m.		h. m.		h. m.		h. m.		h. m.
·22697	0 0	·22704	3 55	·22709	7 51	·22704	10 52	·22709	18 54
96	8	03	4 1	10	7 55	05	53	08	18 56
95	17	04	13	09	8 0	07	54	09	19 1
94	27	05	16	08	1	08	56	10	6
93	0 46	06	22	07	2	07	10 59	11	10
92	1 12	05	28	06	3	06	11 7·3	10	29
92	16	04	37	05	8	05	13·6	11	19 40
	—	03	38	06	15	04	20·3	12	20 7
92	18	04	43	06	21	05	28·6	13	12
93	40	05	46		—	06	34·6	14	17
95	42	04	49	06	30	07	38·6	14	22
96	43	05	54	07	51	06	45		—
97	44	06	56	08	52	05	50·3	14	31
699	46	07	58	09	53	06	52·3	15	39
700	47	09	4 59	10	55	05	52·6	16	20 54
699	52	11	5 0	11	8 59	06	11 57·6	17	21 49
98	53	12	1	10	9 6	05	12 11	18	50
97	1 54	11	2	08	7	06	18	17	51
96	2 1·5	10	8	07	8	06	24	16	53
97	2	11	11	06	9		—	16	57
98	13	10	16	05	10	06	30		—
99	17	09	20	06	11	05	12 55	16	21 59
98	21	09	21	05	25	05	13 9	15	22 11
97	33		—	03	40		—	14	19
98	34	09	23	04	41	05	11	13	26
97	37	10	25	03	42	06	31	12	29
98	40	09	34	04	44	05	13 57	11	31
99	41	07	37	05	50	04	14 4	10	40
98	42	09	42		—	05	12	09	45
699	43	11	5 43	05	52	05	21	08	46
700	44	10	6 29	06	57		—	07	47
	—	11	34	05	9 59	05	24	06	50
00	46	12	42	06	10 0	04	14 59	05	22 56
01	47	11	45	05	1	05	15 10	03	23 2
700	51	11	54	06	2	06	15	02	7
699	2 58		—	05	3	06	50	01	14
98	3 1	11	6 56	04	19		—	700	23
699	2	10	7 2	03	21	05	15 54	699	27
700	3	11	4	04	22	06	16 9	98	28
699	4	10	19	03	24	07	33	97	30
700	8	07	20	02	26	08	16 52	98	39
699	20	09	23	01	27	08	17 17	97	47
700	29	10	24	700	28		—	98	51
699	30	11	25	698	29	08	20	97	52
98	32	12	27	699	31	07	33	96	53
97	33	11	32	700	32	06	45	95	54
98	35	10	33	01	35	07	52	96	56
699	37	09	34	02	39	08	17 56	95	57
700	38	07	35	01	40	07	18 14	96	23 59
01	40	08	39	02	49	08	33	·22694	24 0
02	46	09	40	·22702	10 50	09	40		
·22702	3 48	·22710	7 43		—	·22709	18 51		
	—						—		



## CHANGES of Christchurch Horizontal Force. August 1, 1902.

Value of H.	Begins at—	Value of H.	Begins at—	Value of H.	Begins at—	Value of H.	Begins at—	Value of H.	Begins at—
	h. m.		h. m.		h. m.		h. m.		h. m.
·22679	0 0	·22683	4 38	·22685	9 11	·22682	10 52	·22685	14 40
78	4	84	40	86	13	83	55	85	41
79	8	85	4 46	85	14	82	56	—	—
78	11	86	5 23	84	18	83	10 58	85	43
77	15	86	42	86	19	82	11 0	84	14 48
78	16	—	—	84	20	83	6	85	15 25
77	18	86	5 44	85	21	82	7	85	16 20
78	20	86	7 10	86	23	83	8	—	—
77	0 21	—	—	84	24	82	9	86	23
76	1 7	86	12	85	25	83	10	87	16 29
77	8	85	16	84	26	82	17	86	17 26
76	10	86	29	85	27	83	19	87	32
—	—	85	7 43	86	29	82	20	86	38
77	12	86	8 3·5	85	30	83	21	86	41
76	15	85	4	86	32	82	24	—	—
77	17	83	4·5	85	33	82	41	86	17 51
76	20	84	5	84	39	—	—	86	19 13
77	23	85	6	85	43	84	45	—	—
76	24	84	11	84	44	85	47	86	19 15
77	35	85	14	85	46	84	48	87	20 17
76	36	83	16	84	47	83	11 54	87	39
77	37	84	17	85	48	84	12 7	—	—
76	42	85	19	84	48·5	83	7·6	87	42
77	1 44	84	21	85	49	84	8·6	88	46
77	2 40	86	23	84	50	83	10	87	20 51
—	—	84	24	85	51	84	13	86	21 41
77	2 43	85	25	84	9 59	83	14·3	85	21 57
78	3 9	82	27·5	82	10 4	84	18·3	85	22 16
79	24	84	28	83	5	83	20·6	—	—
80	28	86	30	84	6	84	22·6	83	22
81	3 40	84	31	82	7	83	24·3	82	29
82	4 6	85	35	83	8	84	29·3	81	39
81	7	84	37	84	10	83	30	80	46
82	10	84	40	83	11	84	45·3	79	51
81	11	—	—	84	13	83	47·6	78	52
82	12	84	44	—	—	84	12 58	77	22 56
81	13	85	50	83	15	85	13 7	76	23 11
—	—	84	52	84	17	84	10	75	18
82	19	85	56	83	21	85	11	73	27
83	23	83	56·6	84	29	84	13	72	34
84	25	84	57	83	35	—	—	72	46
83	26	85	8 58	84	36	85	22	—	—
84	29	86	9 8	83	38	84	13 58	72	23 48
83	32	85	9	84	43	83	14 2	·22672	24 0
·22684	4 33	·22686	9 10	·22683	10 44	·22684	14 3	—	—

CHANGES of Christchurch Horizontal Force. August 15, 1902.

Value of H.	Begins at—	Value of H.	Begins at—	Value of H.	Begins at—	Value of H.	Begins at—	Value of H.	Begins at—
	h. m.		h. m.		h. m.		h. m.		h. m.
·22697	0 0	·22698	5 12	22696	8 6	·22700	10 54	·22698	18 52
96	10	97	13	95	7	698	55		—
95	15	96	14	96	10	97	10 59	98	18 55
94	22	97	16	95	12	96	11 2	699	19 40
93	38	97	41	96	33	97	24	700	20 15
92	0 57		—	96	45	98	29	01	22
91	1 6	98	44		—	98	40	01	30
91	11	97	47	97	52		—		—
	—	98	48	96	8 58	98	43	02	20 32
92	13	97	5 51	97	9 0	97	53	03	21 4
91	18	96	6 8 5	96	2	98	11 54	04	41
90	22	97	10	95	13	97	12 9	04	53
89	1 32	96	12	94	21	98	29		—
89	2 46	97	13	95	25	97	35	05	55
	—	96	15	94	26	97	50	05	21 59
90	49	95	27	95	30		—		—
89	2 56	96	30	94	31	97	12 55	05	22 10
90	3 2	95	32	95	39	98	13 5 3	06	13
91	11	96	40	94	40	97	32 6	05	18
92	25	95	41	95	46	98	40	06	28
91	26	96	43	96	48	97	13 50 3	05	29
92	27	95	44	95	50	96	14 1	06	35
93	39	96	45	96	9 51	97	6	05	36
92	41	95	50	97	10 11	98	21	04	48
93	3 42	96	6 58	96	14	98	25	03	22 57
94	4 4	95	7 2	97	16		—	04	23 0
95	20	96	3	97	17	97	14 27	03	1
95	23	95	4		—	96	15 2	02	3
	—	96	31	97	20	97	35	03	4
96	31	95	32	98	34	97	50	02	8
97	37	94	37	97	35		—	01	21
96	41	95	49	98	36	97	15 53	700	24
97	46	94	56	699	40	96	16 13	699	32
96	48	95	57	700	43	97	16 47	98	42
97	4 54	94	7 59	699	44	98	17 1	99	43
98	5 10	95	8 0	701	46	98	23	98	44
99	10 3	96	1	700	51		—	97	23 55
·22694	5 11	·22695	8 3	·22699	10 53	·22698	17 28	·22697	24 0

## CHANGES of Christchurch Horizontal Force. September 1, 1902.

Value of H.	Begins at—	Value of H.	Begins at—	Value of H.	Begins at—	Value of H.	Begins at—	Value of H.	Begins at—
	h. m.		h. m.		h. m.		h. m.		h. m.
.22680	0 0	.22688	2 56	.22689	6 9	.22696	15 8	.22689	21 21
79	6	85	3 3	90	10	97	10	88	32
78	17	84	5	89	26	98	14	87	39
77	20	85	12	90	27	97	28	86	41
78	26	87	13	91	34	96	39	85	44
76	35	88	14	90	6 45	95	15 58	84	51
77	50	89	15	89	7 2	96	16 1	83	21 57
78	51	88	24	90	12	95	3	82	22 2
79	54	87	26	90	29	96	27	81	5
78	55	86	29		—	95	30	80	10
77	58	87	32	90	32	96	34	79	15
76	0 59	88	37	91	46	97	38	78	20
75	1 4	87	44	90	50	96	40	77	27
74	6	88	47	89	7 54	97	43	76	28
73	7	89	3 54	90	8 17	96	45	75	37
72	8	90	4 11	91	40	97	47	75	44
71	9	89	18	92	45	97	48		—
72	10	89	22	91	46		—	74	53
73	11		—	91	48	97	51	73	54
74	12	89	27		—	98	16 56	72	22 57
75	13	88	33	92	53	97	17 10	71	23 0
76	15	87	36	93	58	98	19	70	6
77	16	88	38	92	8 59	99	17 41	71	10 5
78	17	87	41	91	9 9	99	18 21	70	11
79	20	88	44	92	9 52		—	71	16
79	21	89	47	91	10 0	699	26	69	16 5
	—	88	52	92	2	700	28	70	18
79	23	89	53	93	16	01	18 31	69	20
80	32	88	54	92	40	00	19 37	68	24
81	33	87	56	91	48	01	40	69	25
83	35	86	58	92	10 54	700	43	68	28
84	42	87	4 59	91	11 5	699	45	69	35
83	45	89	5 5	92	8	700	49	68	36
81	48	87	6	93	17	700	56	67	38
80	51	88	7	94	24 3		—	68	41
81	1 59	86	8	93	25	699	19 59	69	42
82	2 1	87	9	94	11 55	98	20 17	68	43
83	2	88	20	94	12 0	97	23	69	44
82	11	87	21		—	96	30	70	46
81	13	88	22	94	3	95	33	71	49
82	22	87	30	93	23	94	38	70	52
83	24	88	31	94	42	93	20 51	69	53
84	28	87	32	93	12 56	92	21 4	70	23 58
85	41	88	36	94	13 19	91	10	.22670	24 0
86	51	89	40	94	38	90	14		
87	53	89	57		—	90	15		
.22688	2 54		—	94	13 44		—		
	—	.22690	5 59	.22695	15 6	.22690	21 19		

CHANGES of Christchurch Horizontal Force. September 15, 1902.

Value of H.	Begins at—	Value of H.	Begins at—	Value of H.	Begins at—	Value of H.	Begins at—	Value of H.	Begins at—
.22674	h. m. 0 5	.22693	h. m. 2 25	.22695	h. m. 5 25	.22687	h. m. 9 41	.22693	h. m. 14 21
73	14	94	27	96	—	88	45	94	24
74	16	93	28	97	27	89	46	95	27
75	22	94	37	96	35	90	48	94	39
76	23	95	42	98	39	91	9 51	93	40
75	24	94	47	99	40	90	10 16	94	41
74	25	93	48	98	41	89	28	95	44
73	27	95	49	97	48	88	31	95	47
74	32	94	51	96	49	89	38	96	—
75	35	92	52	95	50	90	39	95	14 51
77	36	91	2 53	96	5 55	91	40	96	15 2 6
77	51	92	3 1	95	6 5	92	41	95	16 5
77	—	93	3	94	13	93	42	95	—
77	55	92	5	93	15	94	43	96	11
78	58	95	6	94	17	93	50	96	16 22
79	0 59	96	8	95	19	92	53	96	17 41
78	1 4	97	9	96	22	91	56	96	—
77	6	98	11	95	25	92	10 59	96	43
78	7	699	12	96	27	93	11 19	97	17 46
79	10	700	13	95	28	94	—	98	18 12
78	11	699	15	94	40	93	22	97	18 28
79	12	700	17	93	42	92	23	98	19 0
80	15	699	20	92	44	91	45	97	1 1
81	16	700	22	93	46	92	51	98	5
82	21	699	24	92	47	93	11 53	97	10
81	26	98	25	91	49	92	12 0	96	27
82	27	699	29	92	51	93	13	95	19 53
83	30	700	31	91	55	92	19	94	20 5
84	32	01	33	91	6 59	93	37	93	13
85	32 6	00	38	91	7 2	92	39	92	38
84	34	00	42	91	—	91	45	91	43
85	35	—	—	91	7 6	91	—	89	53
86	36	01	50	91	8 31	91	51	88	54
87	40	00	52	92	—	92	53	89	55
88	43	01	53	91	42	93	12 56	90	20 57
87	45	00	3 58	92	8 49	92	13 12	89	21 0
88	46	01	4 9	91	9 11	91	16	88	1
89	47	03	21	90	18	92	29	87	2
90	52	04	24	89	20	91	40	86	4
89	1 53	03	29	88	21	92	41	85	11
90	2 0	02	40	89	22	93	43	84	15
91	3	01	43	90	28	94	44	83	19
90	7	00	4 57	91	30	95	13 45	82	22
91	8	01	5 5	89	31	94	14 5	83	24
92	15	700	12	88	33	95	7	.22682	21 25
93	17	697	18	87	34	94	13		
94	19	96	19	.22686	35	.22693	14 17		
.22694	2 23	.22695	5 24		9 36				
	—								Record stops.

## CHANGES of Christchurch Horizontal Force. October 1, 1902.

Value of H.	Begins at—	Value of H.	Begins at—	Value of H.	Begins at—	Value of H.	Begins at—	Value of H.	Begins at—
	h. m.		h. m.		h. m.		h. m.		h. m.
·22675	0 2	·22680	2 23	·22681	4 49			·22686	19 40
74	9	81	25	82	53	·22684	8 54	85	48
75	10	80	26	83	56	85	9 6	84	19 59
74	12	79	38	84	4 57	84	26	83	20 10
73	14	80	39	83	5 1	85	38	82	13
74	15	81	41	84	2	84	49	81	16
73	17	82	42	83	5	83	9 57	80	24
72	26	83	46	82	8	84	10 7	80	32
73	33	84	48	81	10	85	10 57		
74	40	84	49	80	12	86	11 28	77	40
73	42			81	19	86	36	76	47
72	45	84	56	82	23			75	20 54
73	47	85	57	81	24	86	40	74	21 2
74	49	84	58	82	32	85	42	73	4
73	51	83	2 59	82	36	86	11 53	72	12
74	0 58	82	3 0			87	12 0	71	21
73	1 1	81	1	82	39	88	2	70	34
74	2	80	2	83	5 45	87	21	69	37
75	6	79	7	82	6 0	86	27	68	39
76	8	80	10	81	4	85	34	68	21 52
75	13	81	16	82	6	86	12 42		
		82	18	83	10	87	13 4	67	22 0
76	16	83	20	84	14			68	16
77	19	84	25	83	18	87	12	67	19
76	20	85	33	82	25	86	18	68	26
75	24	84	34	83	35	85	34	69	37
76	28	85	35	82	36	86	41	70	41
77	36	84	36	83	38	85	13 59	71	46
76	38	85	39	82	39	86	14 17	70	47 5
77	43	86	44	83	41	87	31	71	48
75	44	85	53	82	44	86	40	72	22 55
76	45	86	3 55	83	45	86	41	73	23 5
75	46	85	4 4	82	46			74	9
76	48	86	5	81	51	86	14 43	75	11
77	53	87	7	82	6 52	87	15 2	76	15
79	58	88	10	81	7 2	87	52	77	19
80	1 59	87	15	82	4			77	21
81	2 0	86	16	83	7	86	15 57		
82	1			82	16	87	16 1	76	29
83	2	87	24	81	27	88	6 6	77	32
82	6	88	25	82	29	89	20 6	76	33
81	8	87	26	81	33	90	34 3	77	40
80	9	86	28	82	55	89	16 37	78	47
81	10	85	29	81	57	89	17 12	79	23 58
80	12	84	31	82	7 58			·22679	24 0
79	17	83	32	81	8 8	89	17 20		
77	18	82	35	82	12	89	19 12		
78	21	81	43	83	24				
·22679	2 22	·22680	4 45	·22683	8 48	·22687	19 20		

CHRISTCHURCH TERM-DAY OBSERVATIONS.

CHANGES of Christchurch Horizontal Force. October 15, 1902.

Value of H.	Begins at—	Value of H.	Begins at—	Value of H.	Begins at—	Value of H.	Begins at—	Value of H.	Begins at—
	h. m.		h. m.		h. m.		h. m.		h. m.
·22672	0 0	·22690	4 28	·22684	6 44	·22678	10 9	·22680	19 4
73	13	89	31	83	47	77	13	80	12
72	19	90	32	84	57	76	20		
73	22	88	37	83	6 58	75	22	81	16
74	39	89	38	84	7 3	74	27	80	32
75	42	90	39	83	4	75	28	79	46
74	46	89	43	84	9	76	32	80	50
75	48	88	44	83	14	77	38	79	54
76	49	89	45	83	16	76	40	78	19 59
75	53	90	46			77	41	77	20 9
76	56	89	48	82	19	76	10 46	76	14
77	57	88	4 53	83	47	77	11 11	75	20
76	0 59	89	5 5	84	49	78	14	74	24
77	1 6	88	11	83	56	79	20	73	30
78	8	87	13	82	7 58	78	25	72	37
78	10	86	17	81	8 0	79	26	72	44
		85	21	80	1	80	27		
79	13	84	23	79	2	79	30	70	50
80	18	83	24	78	5	78	39	69	53
81	20	84	25	79	9	78	42	68	20 59
82	24	85	26	80	10			67	21 7
83	36	86	28	81	12	80	45	66	12
84	45	85	34	82	18	81	55	65	16
85	47	86	39	83	26	82	11 59	64	19
86	49	87	50	84	34	81	12 6	63	25
87	1 56	86	54	83	39	82	12 29	62	33
88	2 2	85	55	82	41	82	13 16	61	37
89	4	84	5 58	82	44			60	41
88	12	85	6 0			82	22	59	21 48
89	15	86	1	81	50	83	44	58	22 15
90	16	85	4	82	8 52	82	13 48	57	21
91	22	84	9	81	9 4	82	16 51	56	28
92	40	83	11	80	6			55	31
93	56	84	12	79	14	82	16 58	56	22 54
94	2 59	85	14	78	17	83	17 14	57	23 15
95	3 3	84	16	79	18	82	18 4	58	18
94	8	85	18	80	22	82	12	59	28
93	12	84	19	81	25			59	39
92	14	83	21	80	28	82	17		
91	3 32	84	28	79	30	81	18	59	42
91	4 12	85	33	78	9 34	80	29	60	23 51
		84	38	·22677	10 5	·22681	18 48	·22661	24 0
·22691	4 19	·22685	6 42						

CHANGES of Christchurch Horizontal Force. November 1, 1902.

Value of H.	Begins at—	Value of H.	Begins at—	Value of H.	Begins at—	Value of H.	Begins at—	Value of H.	Begins at—
	h. m.		h. m.		h. m.		h. m.		h. m.
·22625	0 0	·22653	2 28	·22666	5 3	·22665	9 54	·22671	17 25
26	1	52	32	67	5	64	9 59	72	29
27	4	51	34	68	10	65	10 3·16	71	35
26	11	50	36	69	13	64	3·3	72	38
27	12	50	44	70	15	62	3·5	72	39
28	18	—	—	71	17	64	4	—	—
29	19	51	46	70	26	63	7·5	71	17 45
28	24	50	49	69	30	64	8	70	18 2
29	25	51	54	68	31	63	12	71	7·3
30	26	50	56	69	33	62	12·5	70	16·3
31	27	51	2 59	70	35	63	13	71	28
32	34	52	3 1	71	37	62	13·5	70	18 49·6
33	36	53	2	72	39	63	14	71	19 3
34	40	54	7	72	40	61	23·6	71	8
35	47	55	8	—	—	62	24	—	—
36	48	54	9	72	42	63	24·3	70	10
37	50	55	10	71	46	62	25	69	13
38	51	56	12	72	48	61	27	68	23
39	52	55	14	71	5 59	62	31	67	36
40	56	56	16	70	6 1	61	33	66	46
41	0 57	57	18	69	4	62	34	65	49
40	1 0·3	56	22	68	7	61	52	64	19 55
41	2	55	24	67	14	60	10 55	63	20 8
42	4	56	27	68	18	61	11 1	62	16
43	6	57	30	67	31	62	7	61	19
44	9	58	33	66	32	63	21	60	22
43	11	57	34	65	35	63	41	59	30
42	12	58	36	64	36	—	—	58	39
43	13	57	37	65	43	64	45	57	42
42	17	58	38	66	6 58	65	11 48	56	43
—	—	57	44	65	7 0	66	12 9	—	—
41	22	58	50	66	11	65	12 25	56	45
40	24	59	56	65	20	65	13 7	55	46
41	26	60	3 58	66	37	—	—	54	56
40	27	60	4 0	67	7 46	65	13	53	20 59
39	28	61	4	66	8 1	66	15	52	21 4
38	29	61	7	67	14	65	38	51	9
37	30	—	—	68	16	66	45	50	16
36	37	62	14	69	22	65	13 50	49	25
37	41	61	19	68	24	66	14 8	48	28
38	44	60	22	67	34	65	34	48	30
39	45	62	27	66	35	65	36	—	—
40	48	63	31	65	38	—	—	47	37
41	49	64	34	66	39	66	40	46	41
42	51	65	35	65	40	67	42	45	21 49
43	53	66	38	—	—	68	14 57	44	22 33
44	56	65	40	65	45	67	15 43	45	22 37
45	57	64	42	66	8 58	68	15 47	45	23 7
46	1 59	63	46	67	9 1	68	16 3	—	—
47	2 1	64	47	66	4	—	—	46	10
48	5	65	49	67	13	69	6	47	16
50	7	66	53	66	20	68	21	48	28
51	10	68	55	65	29	69	16 34	49	37
52	15	67	58	64	35	68	17 1	·22649	23 44
53	22	66	4 59	65	39	69	6	—	—
·22654	2 24	·22665	5 1	·22666	9 51	·22670	17 19	Record stops	—

CHANGES of Christchurch Horizontal Force. November 15, 1902.

Value of H.	Begins at—	Value of H.	Begins at—	Value of H.	Begins at—	Value of H.	Begins at—	Value of H.	Begins at—
·22648	h. m. 0 0	·22685	h. m. 3 31	·22684	h. m. 5 42	·22678	h. m. 9 14	·22679	h. m. 11 28
49	3	86	32	83	50	79	15	78	41
50	5	87	32 δ	83	—	78	17	78	42
51	7	89	34	83	54	79	19	—	—
50	8	91	36	84	57	76	20	77	44
51	11	90	38	83	5 58	78	20 1δ	76	46
52	12	89	41	84	6 5	80	21	77	50
53	15	87	42	83	6	79	21 δ	78	53
54	18	86	44	82	12	78	22	79	55
55	20	85	45	81	13	79	22 3	80	57
56	23	86	48	82	20	78	22 δ	81	11 58
57	31	87	49	81	21	79	23	80	12 3
58	37	88	53	82	22	77	24	79	8
59	39	91	54	80	24	76	27	78	10
60	40	93	55	78	25	77	30	79	16
61	46	92	56	77	26	78	31	80	21
62	50	93	57	76	26 5	77	32	79	22
63	51	94	58	77	27	76	33	78	29
64	54	95	59	78	28	75	34	77	32
65	0 56	93	4 2	79	30	76	35	76	35
66	1 5	92	3	78	35	78	36	75	38
	—	90	4	76	37	79	37	76	43
68	13	88	5	75	38	78	39	77	48
69	17	87	6	74	39	77	40	78	51
70	20	88	9	75	40	76	43	79	57
71	30	88	14	74	41	77	45	78	12 58
70	36	—	—	72	42	78	47	79	13 1
71	37	89	25	71	43	77	50	78	1 δ
72	45	90	27	70	44	76	53	79	2
71	50	88	29	71	48	77	56	79	10
72	54	87	30	72	55	78	57	—	—
73	1 58	88	34	73	6 56	79	9 58	77	19
74	2 0	89	37	72	7 2	80	10 0	79	20
73	3	90	38	73	6	82	1	80	26
74	6	89	39	74	11	83	1 5	81	28
75	9	88	41	75	14	82	2	82	29
76	16	87	43	75	19	81	3	81	30
77	21	88	44	—	—	82	4	82	31
78	29	89	46	75	23	80	5	81	32
79	32	88	47	74	25	79	6	80	33
79	41	87	49	73	30	76	8	81	37
	—	86	50	74	31	77	9	82	38
80	44	84	51	75	35	76	11	83	41
82	47	83	51 3	74	36	75	14	82	42 δ
81	48	80	52 3	75	38	—	—	83	43
80	50	81	53	76	40	76	19	84	44
81	52	83	54	75	41	75	20	83	45
82	53	84	54 δ	74	49	74	24	84	13 57
81	55	86	55	75	50	75	29	83	14 1
82	2 57	87	55 3	76	54	74	30	82	12
83	3 0	88	4 58	77	55	75	31	81	16
84	1	87	5 7	76	7 59	76	35	80	25
83	3	88	9	75	8 11	77	37	79	26
84	5	87	10	76	16	78	42	78	29
83	7	86	11	77	23	77	49	77	32
82	11	85	12	76	26	76	51	78	37
81	14	86	14	75	36	77	52	79	38
79	16	87	17	74	40	76	53	80	41
78	18	88	19	76	46	75	56	81	43
77	19	87	22	—	—	76	10 59	80	46
75	25 δ	86	26	78	8 54	77	11 5	79	47
76	26	87	28	77	9 1	76	9	78	50
79	27	86	32	76	5	77	11	78	53
81	28	85	33	75	8	76	21	—	—
82	29	84	37	76	12	77	24	78	56
·22683	3 30	·22683	5 41	·22677	9 13	·22678	11 26	·22679	14 59



CHANGES of Christchurch Horizontal Force. November 15, 1902—*continued.*

Value of H.	Begins at—	Value of H.	Begins at—	Value of H.	Begins at—	Value of H.	Begins at—	Value of H.	Begins at—
	h. m.		h. m.		h. m.		h. m.		h. m.
·22687	15 8	·22686	17 23	·22691	19 34·6	·22669	20 57	·22656	22 28
81	10	87	26	90	35·6	68	21 3	55	29
82	11	87	41	89	37·6	66	5	56	30
81	16		—	88	40·6	65	13	55	36
80	18	87	47	89	45	66	17	56	37
79	20	86	50	88	47·3	65	21	55	38
78	24	87	53	87	19 54	64	22	56	40
77	29	86	54	87	20 13	63	28	55	43
76	41	87	17 55		—	62	29	54	43·3
77	42	88	18 9	87	15	63	30	55	43·5
78	15 57	89	12	86	18	62	31	53	43·6
79	16 6	91	14	85	19	61	33	55	44
79	16 14	90	16	84	20	60	38	54	45
	—	89	17	83	23	59	41	55	49
80	16	91	18	82	25	59	42	54	50
81	20	92	20	81	28		—	54	54
82	23	93	22	80	29	59	48		—
81	30	91	24	79	30	58	52	56	22 58
82	31	90	34	78	33	57	55	57	23 14
81	35	91	40	77	35	56	21 58	56	30
82	39	90	45	76	37	55	22 12	57	31
81	40	89	51	75	39	56	13	56	32
82	47	89	54	74	45	55	15	57	47
83	16 58		—	73	47	56	17	59	52
84	17 11	90	18 57	72	49	55	18	60	23 56
85	17 13	89	19 0	71	51	56	19	·22660	24 0
·22684	17 15	·22690	19 33·6	·22670	20 52	·22655	22 24		

CHANGES of Christchurch Horizontal Force. December 1, 1902.

Value of H.	Begins at—	Value of H.	Begins at—	Value of H.	Begins at—	Value of H.	Begins at—	Value of H.	Begins at—
	h. m.		h. m.		h. m.		h. m.		h. m.
·22641	0 0	·22677	5 48	·22674	10 38	·22675	12 55	·22681	18 3
40	1	76	49	73	39	74	56	82	14
41	9	75	56	74	42	73	57	81	19
42	25	74	57	73	43	74	12 59	82	27
43	28	75	58	74	44	73	13 0	81	32
44	34	74	5 59	76	46	74	1	80	42
45	37	73	6 4	78	47	75	9	79	18 58
46	40	74	13	79	48		—	78	19 3
47	48	73	16	81	49	74	16	78	10
48	0 52	74	22·3	82	51	73	29		—
49	1 2	73	23	81	53	72	31	78	15
50	4	74	24	80	56	71	40	77	17
51	8	73	25	79	57	70	44	76	24
52	10	74	27	80	10 59	71	45	75	26
53	12	73	28	78	11 3	70	49	74	27
54	15	71	28·5	79	4	69	13 54	73	32
55	18	73	29	77	9	68	14 0	72	39
	—	72	31	78	14	67	12	71	46
56	23	74	32	77	16	68	14	70	49
55	24	73	33	78	17	67	23	69	51
56	25	72	34	77	19	68	24	68	55
57	28	73	36	76	26	67	25	68	56
58	31	71	40	77	31	68	26		—
59	33	72	41	77	42	69	28	68	19 59
60	44	71	44		—	70	30	67	20 4·3
61	46	72	50	75	46	69	31	66	11·3
62	48	71	52	76	11 58	70	32	65	17
63	54	72	53	77	12 3·6	70	38	64	28·3
64	1 58	71	54	76	4		—	63	37·3
65	2 4	72	6 56	75	4·16	72	41	62	42
66	7	71	7 1	77	4·6	73	49	61	46·6
67	19	72	4	76	5	72	55	60	47·6
68	22	73	14	77	5·5	73	14 56	61	48·6
69	28	72	15	78	5·83	72	15 28	60	20 49
70	36	73	16	77	6	71	32	60	21 1
71	38	73	17	76	6·3	70	34		—
72	40		—	77	6·6	71	35	61	7
72	45	73	19	79	8	70	36	60	12
	—	72	35	77	8·3	71	15 55	59	16
74	48	73	7 55	78	9	70	16 0	58	28
75	2 53	73	8 45	77	13	71	6	57	31
76	3 1		—	78	15	71	7	56	34
77	9	74	51	77	18		—	55	47
78	15	73	8 59	76	21	71	10	54	21 51
77	23	74	9 24	77	26	72	11	53	22 2
76	30	75	28	78	26·6	71	16	52	11
77	31	74	29	77	27	72	17	53	15
78	41	75	33	78	28·6	73	30	52	22
79	43	74	43	76	30	74	39	51	24
80	45	75	50	79	31	75	44·83	50	25
81	53	74	51	77	32	74	45	49	34
82	3 59	75	56	78	33	73	50	50	22 39
83	4 10	74	9 57	77	34	74	51	51	23 8
83	13	73	10 0	76	34·5	73	52	52	11
	—	74	3	77	35	74	53	53	12
83	20	74	6	78	35·5	75	16 58	52	18
82	25		—	76	36·5	76	17 0	51	24
83	39	74	9	77	37	77	3	50	27
82	4 54	75	12	76	39	78	10	51	30
81	5 5	74	13	77	40	79	16	52	32
80	11	73	15	76	41	80	22	53	33
79	26	74	16	77	42	79	26	54	39
78	33	75	17	75	43	80	27	55	49
77	39	73	18	76	44	81	28	56	55
77	42	74	19	75	45	82	37	57	56
	—	73	23	74	47	82	41	58	23 57
77	44	74	25	75	48		—	·22658	24 0
·22676	5 47	·22673	10 27	·22674	12 54	·22682	17 46		

CHANGES of Christchurch Horizontal Force. December 15, 1902.

Value of H.	Begins at—	Value of H.	Begins at—	Value of H.	Begins at—	Value of H.	Begins at—	Value of H.	Begins at—
.22647	h. m. 0 0	.22672	h. m. 2 39	.22666	h. m. 7 2	.22667	h. m. 13 1	.22647	h. m. 20 24
46	4		—	65	6	68	13	46	26
47	10	71	41	66	24	67	18	45	29
48	12	70	44	65	26	67	19	45	35
49	15	68	45	64	35		—		—
48	19	67	45 <sup>3</sup>	65	41	66	24	44	37
49	24	69	46	66	7 58	67	33	43	42
50	27	70	47	65	8 6	68	13 46	42	48
51	30	71	49	64	10	67	14 11	41	49
52	35	72	51	65	11	66	25	40	54
53	37	73	52	66	19	67	28	41	0
52	39	72	53	65	21	67	40	40	1 <sup>3</sup>
53	40	73	54	66	32		—	39	7 <sup>3</sup>
52	42	72	2 58	67	39	67	43	38	15 <sup>6</sup>
51	46	71	3 0		—	66	48	37	16 <sup>3</sup>
50	48	70	1	68	45	67	14 53	36	20
51	52	72	4	67	51	68	15 18	35	33
52	53	71	14	68	55	67	26	34	44
53	54	70	16	67	8 58	66	33	35	50 <sup>6</sup>
54	0 55	68	18	68	9 5	67	49	34	21 59 <sup>6</sup>
54	1 3	67	20	66	7	68	15 55	35	22 1
	—	66	21	67	8	68	16 8	36	6
57	6	67	25	68	12		—	35	8
58	7	68	26	67	14		—		—
	—	69	36	68	18	68	10	33	13
58	12	70	37	67	19	69	17	32	16
59	16	71	39	68	27	70	25	33	20
58	18	72	43	67	46	71	32	32	22
59	19	73	46	68	9 54	72	16 44	33	23
58	23	74	47	68	10 15	73	17 34	32	30
57	24	75	49		—		39	33	32
58	25	76	53		—		—	32	33
57	26	75	55	68	17	72	46	33	35
58	32	76	3 59	69	20	71	17 51	32	37
59	34	77	4 2	70	24	70	18 4	33	38
60	37		7	69	27	69	10	34	42
61	39	77	—	68	33	68	13	33	43
62	40	78	14	69	34	67	22	34	47
61	41	77	19	68	39	66	29	35	49
62	43	76	22	68	10 40	65	33	36	53
63	46	75	55	69	11 7	64	40	37	56
64	55	74	4 58	69	8	63	18 49	38	22 59
63	58	75	5 1	70	12	62	19 5	39	23 6
64	1 58	74	6	69	13	62	8	40	9
64	2 6	74	19	68	18		—	41	15
65	8	73	31	69	28	61	10	42	16
66	11	72	37	69	35	60	13	41	23
67	14	73	39		—	59	18	42	27
68	17	73	44	68	11 37	58	27	43	28
70	22		—	67	12 7	57	33 <sup>3</sup>	42	32
69	24	73	47	66	11	56	34	43	36
70	25	72	5 57	65	26	55	41	43	39
71	26	71	6 5	66	29	54	47		—
70	28	70	6	67	32	53	19 58	43	41
69	30	69	26	66	36	52	20 2	44	46
68	31	68	28	67	39	51	6	45	23 50
69	35	67	6 42	66	46	50	8	.22645	24 0
70	37	.22666	7 0	67	12 57	49	13		
.22671	2 38		—	.22666	13 0	.22648	20 18		

CHRISTCHURCH TERM-DAY OBSERVATIONS.

CHANGES of Christchurch Horizontal Force January 1, 1903.

Value of H.	Begins at—	Value of H.	Begins at—	Value of H.	Begins at—	Value of H.	Begins at—	Value of H.	Begins at—
·22647	h. m. 0 0		h. m. —	·22680	h. m. 7 55	·22684	h. m. 13 55	·22685	h. m. 20 41
48	9	·22697	4 18	81	57	85	13 57	84	46
49	11	96	21	80	7 59	84	14 2	83	50
48	12	97	25	82	8 1	84	37	82	51
49	16	96	30	83	1 5			81	53
50	18	95	45	82	2	84	14 41	80	56
51	22	94	48	80	2 5	86	15 0	79	20 59
52	24	95	53	81	3	85	2	78	21 1
53	26	94	4 57	82	3 5	84	4	77	2
52	29	93	5 0	83	6	85	53	76	7
53	31	92	10	82	7	86	56	75	8
54	44	93	11	81	8 3	85	57	74	13
53	45	92	16	82	9	86	15 59	73	16
54	0 56	91	21	84	10	88	16 0	72	18
54	1 0	90	23	83	11	87	8	71	20
		91	26	84	13	87	11	70	23
55	3	90	28	83	15			69	26
56	8	91	33	84	16	87	13	68	29
57	18	92	35	83	17	86	14	67	32
58	20	93	37	84	18	85	15	66	35
59	24	92	40	83	20	86	16	66	39
60	30	92	44	84	21	87	20		
61	37			84	43	88	21	64	45
62	41	91	46			89	22	63	46
63	45	90	48	84	48	88	23	62	50
64	48	89	52	83	52	87	28	61	53
63	49	90	54	84	53	86	30	60	54
64	50	91	5 57	82	55	87	35	59	21 56
65	51	89	6 2	83	56	86	37	58	22 0
66	54	88	4	84	8 57	85	38	57	5 6
67	1 57	89	7	85	9 8	86	44	56	10 3
68	2 0	90	9	84	10	87	48	55	14
70	2	91	10	83	13	86	50	54	17 6
71	4	90	11	84	14	87	51	55	19
72	7	89	12	83	27	86	52	54	20
73	9	88	19	84	9 40	87	16 53	55	21
74	13	87	21	84	10 4	88	17 1	54	22
75	15	86	24			89	19	53	26 3
76	16	85	25	84	6	90	30	52	38 3
77	18	86	26	83	7	90	39	53	39
78	19	85	28	84	29			52	41
79	21	84	31	83	10 56	91	46	51	46
80	26	83	34	84	11 2	92	17 49	50	51
81	28	84	38	86	23	91	18 3	49	51 6
82	29	83	45	85	27	92	10	48	54
83	30	82	52	86	28	93	12	49	57
84	32	81	6 56	85	31	92	13	48	22 59 3
85	35	82	7 1	84	34	93	21	47	23 14
				85	38	92	22	47	16
87	38	81	4	85	39	93	30		
88	42	80	5			93	48	46	19
89	48	79	6	84	11 41			45	23
90	53	80	8	83	12 41	94	18 52	44	26
91	57	81	9	82	44	95	19 23	43	31
92	2 59	82	14	83	49	94	35	42	34
93	3 1	83	19	84	12 55	93	19 57	43	37
94	16	82	26	85	13 8	92	20 6	44	41
93	19	81	29	86	10	92	7	45	44
94	22	82	30	85	13			46	49
93	27	81	32	86	15	92	9	47	53
94	31	82	35	86	16	91	11	46	54
95	38	81	37			90	20	47	56
96	43	82	40	84	21	89	24	48	23 58
97	3 45	81	41	85	39	88	29	·22648	24 0
98	4 3	82	47	86	42	87	32		
·22698	4 11	·22681	7 52	·22685	13 44	·22686	20 38		

CHRISTCHURCH TERM-DAY OBSERVATIONS.

CHANGES of Christchurch Horizontal Force. January 15, 1903.

Value of H.	Begins at—	Value of H.	Begins at—	Value of H.	Begins at—	Value of H.	Begins at—	Value of H.	Begins at—
	h. m.		h. m.		h. m.		h. m.		h. m.
·22673	0 0	·22690	3 46	·22692	6 27	·22689	10 18	·22693	17 44
74	2	89	49	93	29		—	92	17 53
75	7	90	52	94	33	86	11 47	91	18 13
76	13	91	3 56	93	35	87	49	90	19
77	15	90	4 0	94	37	86	51	89	28
78	18	89	1	95	43	87	11 58	89	55
79	22	91	5	94	6 44	86	12 4		—
80	24	90	11	93	7 1	87	10	89	18 57
81	27	90	15	94	4	88	20	88	19 2
82	29		—	94	6	87	22	87	5
83	38	89	20		—	89	23	86	9
84	44	90	23	94	9	90	30	85	19
85	49	89	25	93	20	91	46	84	28
86	53	90	30	92	26	90	51	83	38
87	55	89	32	91	28	91	52	82	47
88	56	90	34	90	31	90	54	81	49
87	57	91	40	89	36	91	12 55	80	53
86	58	90	44	88	7 58	92	13 1	79	19 58
87	0 59	91	46	87	8 4	91	6	78	20 3
88	1 0	90	47	88	26	92	7	77	8
89	1	92	48	89	28	93	8	76	14
88	4	91	51	90	32	94	13	75	17
89	7	92	55	89	36	93	14	74	25
89	8	91	56	88	43		—	74	30
	—	93	4 58	89	44	92	20		—
89	10	92	5 0	88	45	91	35	73	32
88	14	94	4	88	47	90	41	72	34
89	17	93	10		—	89	56	71	38
88	20	92	11	89	50	90	13 58	70	43
87	22	91	12	88	51	91	14 5	69	48
86	29	92	20	87	53	92	10	68	51
87	31	93	23	89	8 59	93	14	67	53
88	40	92	25	87	9 0	92	15	66	20 55
89	47	94	27	88	0 5	91	19	65	21 7
88	51	93	30	86	1	90	22	65	21 9
87	52	92	31	88	2	89	26		—
88	54	93	34	89	3	90	36	54	22 18
89	56	92	35	88	4	91	45	53	21
88	1 59	91	36	89	5	92	47	52	27
87	2 2	92	39	88	17	91	14 51	51	31
86	16	93	48	89	19	90	15 2	50	40
85	24	94	49	86	20 6	89	7	51	47
86	31	94	51	88	22	88	15 26	51	50
85	34		—	87	26	87	16 0		—
86	36	93	54	88	29	88	2	51	53
87	40	94	5 59	87	33	89	10	52	22 59
86	42	95	6 0	88	34	88	12	58	23 4 3
	—	96	1	89	36		—	54	13 6
87	48	95	3	88	43	88	14	55	17 3
86	50	94	5	89	48	89	20	56	20 6
87	2 59	93	7	88	49	90	40	57	24 3
88	3 2	92	9	89	53	91	43	58	54 3
89	7	91	10	88	9 56	90	48	59	23 57
88	8	92	14	89	10 1	91	16 59	·22659	24 0
89	9	91	15	89	4	92	17 7		—
90	44	90	19		—	·22692	17 38		—
·22689	3 45	·22691	6 20	·22689	10 7		—		—

CHANGES of Christchurch Horizontal Force. February 1, 1903.

Value of H.	Begins at—	Value of H.	Begins at—	Value of H.	Begins at—	Value of H.	Begins at—	Value of H.	Begins at—
	h. m.		h. m.		h. m.		h. m.		h. m.
·22666	0 0	·22697	4 7	·22693	7 18	·22693	16 3	·22683	20 15
67	10 3	98	14	92	23			82	16
66	16 3	96	29	93	28	93	5	81	19
67	52 3	97	30	94	47	92	16 51	80	26
68	0 57	98	31	93	7 54	91	17 16	79	31
69	1 1	97	33	94	8 23	92	20	78	37
70	6	98	34	94	26	91	23	77	46
70	9	97	35			92	28	76	50
		98	37	93	32	92	31	75	20 51
70	12	97	39	94	36			74	21 6
71	28	96	51	93	37	93	36	73	16
72	36	97	53	94	38	94	53	72	21
73	42	98	4 58	93	8 39	95	56	71	23
74	49	97	5 0	92	9 39	96	58	70	26
75	1 59	98	1	92	49	95	17 59	70	32
76	2 3	97	15			96	18 0		
77	6	96	16	93	9 52	95	7	70	21 36
78	9			92	10 3	96	9	71	22 28
79	15	96	21	93	27	95	15	72	31
80	18	97	22	92	40	94	21	73	33
81	21	96	31	93	10 59	95	24	72	37
82	23	97	32	93	11 25	94	25	73	39
83	31	96	36			93	27	72	42
84	37	97	37	93	27	94	29	73	43
84	38	96	38	92	11 54	93	18 31	74	50
		95	43	93	12 27	93	19 4	73	51
84	40	96	44	93	51			74	22 52
85	42	95	46			93	6	74	23 8
86	44	96	53	93	12 55	92	9		
87	47	97	5 55	92	13 28	91	12	75	11
88	2 59	96	6 1	91	42	90	16	74	20
89	3 9	97	5	90	44	89	18	73	38
90	13	98	18	91	13 54	88	29	72	40
91	17	98	47	92	14 10	87	35	73	42
92	19			92	27	86	45	74	47
93	27	97	51			85	48	73	23 52
94	47	96	52	93	29	84	19 56	22673	24 0
94	49	95	6 55	92	38	84	20 3		
		94	7 1	93	14 59				
95	3 52	93	3	92	15 29	83	9		
·22696	4 2	·22692	7 13	·22693	15 57	·22684	20 11		

CHANGES of Christchurch Horizontal Force. February 15, 1903.

Value of H.	Begins at—	Value of H.	Begins at—	Value of H.	Begins at—	Value of H.	Begins at—	Value of H.	Begins at—
.22649	h. m. 0 0	.22671	h. m. 3 12	.22681	h. m. 9 11	.22675	h. m. 13 35	.22675	h. m. 17 24
50	2	72	17	82	17	74	38	—	—
51	3	73	19	81	21	73	39	73	30
52	4	74	28	82	22	72	41	72	33
53	10	75	29	83	25	71	44	73	17 44
52	11	76	33	82	31	72	48	74	18 1
53	15	77	34	83	34	73	51	75	3
52	16	76	35	82	39	72	52	74	6
53	17	77	39	—	—	73	53	73	14
52	23	78	42	83	42	74	57	74	18
53	24	—	—	82	43	75	13 59	73	19
54	27	79	3 48	81	9 45	74	14 7	74	20
55	28	79	4 0	80	10 0	75	12	73	22
54	32	—	—	79	5	78	17 6	72	31
55	33	87	5 21	78	7	75	18	71	38
56	41	88	28	79	9	77	19 3	72	51
57	44	87	34	78	10	75	20	—	—
58	52	88	36	79	11	74	22	72	53
—	—	87	47	78	15	75	23	71	18 56
59	0 56	86	5 51	77	19	75	26	70	19 4
60	1 7 3	87	6 6	76	20	—	—	69	13
59	8 6	86	14	77	23	75	28	68	20
60	10 6	85	24	76	24	76	46	67	24
59	12 6	84	26	75	29	77	48	66	39
60	18	83	30	76	32	76	50	65	46
59	19	84	36	75	36	78	51	66	48
60	22	85	38	74	10 37	79	14 55	65	52
61	25 3	86	41	75	11 4	80	15 0	64	53
60	28 3	86	44	76	5	81	3	63	19 56
61	31 3	—	—	77	9	82	5	62	20 0
60	33	84	47	76	10	81	9	61	2
59	33 3	83	50	77	13	80	10	—	—
60	36	82	6 56	78	17	81	11	62	9
61	37 3	81	7 1	77	18	80	18	61	15
60	38 3	80	12	—	—	81	36	60	17
61	41 3	79	15	77	20	80	43	59	22
60	42 6	80	16	76	23	80	49	58	25
61	44	81	17	75	24	—	—	57	27
62	54	83	19	76	26	80	51	56	29
61	56 3	82	23	75	27	79	53	55	35
62	1 58 3	81	25	74	29	78	54	54	43
63	2 3	82	32	75	11 49	77	15 58	53	47
62	5	81	33	74	12 0	76	16 1	52	53
61	7	82	47	73	3	75	4	51	56
60	8 6	83	48	74	8	74	10	50	20 59
61	9	82	52	75	14	73	15	49	21 6
62	10	81	56	76	15	71	17	48	9
63	12	83	58	75	19	70	18	47	12
62	14	82	7 59	74	22	69	19	46	16
63	18	83	8 0	75	28	68	20	45	20
64	19	84	2	74	33	67	22	44	29
65	23	85	4	73	38	66	23	43	35
—	—	86	6	72	40	65	25	42	47
66	26	86	10	73	42	64	27	42	48
67	31	—	—	74	45	63	32	—	—
66	33	86	15	74	50	64	34	41	50
67	35	85	16	—	—	65	37	40	21 53
66	36	84	17	72	12 56	66	39	41	22 8
67	37	83	19	73	13 0	67	44	40	22 20
66	38	82	21	72	1	69	45	39	23 8
67	41	81	25	73	2	70	48	40	15
68	43	82	31	74	6	71	49	40	16
69	46	81	36	73	7	72	52	—	—
70	51	82	43	74	8	73	53	38	20
69	53 3	83	45	75	12	74	55	37	34
70	58	82	46	74	17	75	16 56	38	37
71	2 59	81	8 51	75	24	76	17 2	37	41
70	3 1	80	9 6	74	30	77	4	38	23 44
69	6	79	7	75	31	76	12	.22638	24 0
.22670	3 8	.22680	9 9	.22674	13 32	.22675	17 13	—	—

CHANGES of Christchurch Declination during International Term Hours, 1902-3.

Date.	Value.	Begins at—	Date.	Value.	Begins at—	Date.	Value.	Begins at—
1902	° /	h. m.	1902	° /	h. m.	1902	° /	h. m.
March 1	16 16·6	2 0	June 1	16 14·0	8 19·3	September 15	16 16·4	15 0
	16·7	5		13·9	36		16·5	5·3
	16·6	9·6		14·0	40·3		16·6	9·3
	16·5	20·3		14·1	43·3		16·7	12·6
	16·6	23·3		14·3	44·3		16·6	14·6
	16·7	30·3		14·4	45·3		16·5	20
	16·9	40		14·5	46·6		16·6	25·6
	17·0	2 52·3		14·6	48·6		16·5	28·3
	16 17·0	3 0		14·7	8 52		16·6	33
				16 14·7	9 0		16·5	36·3
March 15	16 19·1	3 0	June 15	16 14·2	9 0		16·6	15 58·3
	19·0	8·3		14·3	5·3		16 16·6	16 0
	18·9	9·3		14·2	9·6	October 1	16 16·6	16 0
	19·0	18·3		14·1	15·6		16·7	5·3
	18·9	31·3		14·2	34·3		16·8	6·6
	18·7	47		14·1	45·6		16·9	11
	18·6	47·6		14·0	9 55·6		17·0	13·3
	18·5	48·6		16 14·0	10 0		16·9	20·3
	18·4	49	July 1	16 14·5	10 0		16·8	40·3
	18·3	50·3		14·4	8		16·7	41·6
	18·2	3 58		14·3	10 21·3		16·6	16 47·3
	16 18·2	4 0		16 14·3	11 0		16 16·6	17 0
April 1	16 17·0	4 0	July 15	16 14·7	11 0	October 15	16 15·3	17 0
	16·9	3·6		14·8	4		15·2	22·6
	16·8	4·3		14·7	7·6		15·1	39
	16·9	4·6		14·7	10·3		15·0	41·6
	16·8	5		14·8	13		14·9	49·6
	16·7	8·6		14·7	16·3		14·8	17 57·3
	16·6	20		14·8	32·3		16 14·8	18 0
	16·4	22·6		14·7	42	November 1	16 14·0	18 0
	16·3	28·3		14·8	52·3		13·9	7·3
	16·2	40·3		14·7	11 56		13·8	14·3
	16·1	42·3		14·8	12 0		13·7	17
	16·0	47·6	August 1	16 15·3	12 0		13·5	20·3
	15·9	50·3		16 15·3	13 0		13·4	25·3
	15·8	54·3	August 15	16 15·8	13 0		13·3	27·3
	15·7	56·6		15·9	0·3		13·2	29·3
	15·5	4 59·3		15·8	9·6		13·1	32·6
	16 15·5	5 0		15·9	11·6		13·0	36·3
April 15	16 14·9	5 0		15·8	12·3		12·9	45
	15·0	2·6		15·9	19·3		12·7	48·6
	14·9	7		15·7	20·6		12·6	50
	14·8	26·6		15·5	26·3		12·5	53
	14·7	35·6		15·7	29·3		12·4	18 54
	14·8	5 43·3		15·5	29·6		16 12·4	19 0
	16 14·7	6 0		15·7	30	November 15	D. record	lost
May 1	16 15·3	6 0		15·7	31·3	December 1	16 11·2	20 0
	15·5	1·6		15·5	33·3		11·0	1·6
	15·3	3·3		15·7	35·3		10·9	14·3
	15·5	9·6		15·5	35·6		11·0	19·6
	15·3	15·6		15·7	36		11·2	41·6
	15·2	17·6		15·8	40		11·0	20 47
	15·1	30		15·7	43·3		16 11·0	21 0
	15·0	6 47·6		15·8	44	December 15	16 11·4	21 0
	16 15·0	7 0		15·7	44·6		11·5	5·3
May 15	16 15·1	7 0		15·8	46		11·6	11·6
	15·0	4·3		15·7	47·6		11·7	15
	15·1	8		15·8	54		11·8	17·3
	15·0	17·6		15·7	54·3		11·9	23
	14·9	7 57·6		15·8	57·3		12·1	27·6
	16 14·9	8 0		15·7	13 58·3		12·2	31
June 1	16 13·9	8 0	September 1	16 16·3	14 0		12·3	34·3
	13·8	3·3		16·1	9·3		12·4	39·6
	13·7	5·6		16·3	12·6		12·5	42
	13·6	7		16·4	14 58		12·6	44·6
	13·7	12		16 16·4	15 0		12·7	45·3
	13·8	14·6					16 12·8	21 48
	16 13·9	8 17·3						



## CHANGES of Christchurch Declination during International Term Hours, 1902-3 (continued).

Date.	Value.	Begins at—	Date.	Value.	Begins at—	Date.	Value.	Begins at—
1902	° /	h. m.	1903	° /	h. m.	1903	° /	h. m.
December 15	16 13·0	21 51·3	January 1	16 13·1	22 49	February 1	16 16·5	0 29
	13·1	54		13·3	49·6		16·6	31·6
	13·2	56·6		13·4	52		16·7	35·6
	13·3	21 58·3		13·5	52·6		16·8	37·6
	16 13·3	22 0		13·6	54		16·9	39·6
				13·7	22 57		17·0	40
1903				16 13·7	23 0		17·1	41·3
January 1	16 10·1	22 0	January 15	16 15·7	23 0		17·2	41·6
	10·2	1·6		15·8	1·3		17·4	43
	10·3	5·6		15·9	6·6		17·5	45
	10·4	9		16·1	17·3		17·6	47·6
	10·5	9·3		16·2	19·6		17·7	50·6
	10·6	11		16·3	22·6		17·8	55·6
	10·5	12		16·4	24		17·9	57·6
	10·6	12·6		16·5	28		18·0	0 59·3
	10·7	13·6		16·6	32·3		16 18·0	1 0
	10·9	14·3		16·6	32·3	February 15	16 19·8	1 0
	11·0	14·6		16·7	34·3		20·0	3
	11·1	15		16·8	36·6		20·1	8·6
	11·2	17		17·0	43		20·2	11
	11·3	20		17·1	46·6		20·3	12·3
	11·5	25·3		17·2	51·3		20·4	13·3
	11·6	27		17·3	54		20·5	16·6
	11·7	28		17·4	55		20·6	19·3
	11·8	28·3		17·5	57·3		20·7	20·6
	11·9	29·3		17·6	23 58·6		20·9	23·3
	12·0	31·3		16 17·7	24 0		21·0	30·3
	12·1	32·3	February 1	16 15·3	0 0		21·1	40
	12·2	33		15·4	1·3		21·3	41
	12·4	35·3		15·6	8·6		21·4	42·6
	12·5	37·3		15·7	10·3		21·5	44·6
	12·6	41·3		15·8	14·6		21·6	45·6
	12·7	44·3		15·9	17		21·8	46
	12·8	45·3		16·0	19·3		21·9	51·6
	12·9	45·6		16·1	21·6		22·0	1 55·3
	13·0	46		16·2	25·6		16 22·0	2 0
	13·1	46·6		16 16·3	0 27			
	16 13·3	22 47·6						

§4. To make sure that the tables will be correctly interpreted by the reader, let us consider the Horizontal-Force data for the first term day, March 1, 1902. At 0h. 0m., G.M.T., when the term day commenced, the value of H was  $\cdot 22672$ , and no departure from this of as much as  $\cdot 00001$  (the unit adopted) was recorded until 0h. 3m., when the value had fallen to  $\cdot 22671$ . During the next minute it rose again to its initial value, and then, after the lapse of 3 minutes, fell a second time to  $\cdot 22671$ . So it went on, now up, now down, with on the whole an upward tendency until 1h. 15m., when the value recorded was  $\cdot 22680$ . This persisted for the next 16 minutes—*i.e.* until 1h. 31m.—when a break of 6 minutes occurred in the observations, indicated by a dash in the time column. Readings were resumed at 1h. 37m., when the force had risen by  $\cdot 00004$ . Details of what occurred during the 6-minute interval are necessarily unknown.

The term hour on March 1, 1902, was from 2h. 0m. to 3h. 0m., and a considerable number of the changes recorded during this hour were at 20 seconds ( $0\cdot 3$  minutes) or 40 seconds ( $0\cdot 6$  minutes) after the exact minute. Observations at 20-second intervals, as has been already explained, were as a rule made during several hours of each term day; but in addition to the sheets in which these observations appeared there were others which recorded only the results answering to 1-minute observations, and except for the actual term hours I have confined myself to the latter. Occasionally observations of turning-points taken at fractions of a minute were inserted in the 1-minute tables, and when these existed they were made use of.

In the case of H the first three significant figures were always either  $\cdot 226$  or  $\cdot 227$ , and the difference between two consecutive readings was never large. It was thus seldom necessary to print more than the

two last significant figures. Three were necessary only when, as sometimes happened, H was rising or falling in the immediate neighbourhood of the value  $\cdot 22700$ . In the case of D the value always lay between  $16^\circ$  and  $17^\circ$  east, thus minutes only are recorded except at the beginning and end of each hour.

Before drawing conclusions from the term-day data it will be convenient to consider the nature of the regular diurnal variation.

§5. Christchurch is a comparatively new magnetic station, and particulars of the regular diurnal variation there do not seem as yet to have been published. There is thus no direct evidence that the hourly readings on term days, pp. 177–179 of the “Physical Observations,” can be regarded as representative of undisturbed conditions at Christchurch. This is, however, the conclusion to which the character of the results points, and it seems sufficiently confirmed by the character of the synchronous results from Greenwich, Kew, Falmouth, Pola, Bombay, and Mauritius, stations whose general characteristics are known. Considering the limited number of days, perfectly smooth diurnal inequalities could not be expected from the Christchurch data, even for the year as a whole. There being only two days a month, diurnal inequalities for individual months would clearly have been too uncertain. Examination of the data showed, however, that, as is usual in corresponding northern latitudes, the variation in the *type* of the diurnal inequality throughout the year is not large, and that sub-division of the year into Midwinter (May to August), Equinox (March, April, September, October), and Midsummer (November to February) would combine months in which the type was closely similar and the amplitude not widely different. Diurnal inequalities for D and H were thus derived for the three seasons and the year. In the case of V the apparent range was so small that, taking the discontinuities into account, the results appeared too uncertain for publication.

Referring to “Physical Observations,” pp. 177 and 178, it will be seen that data are lacking for the second midnight of November 1, and for hours 10 p.m. to midnight on September 15. These missing values were replaced by interpolation, in such a way as not to influence the conclusions one would have derived from the remaining days as to the diurnal variation during the hours of the day concerned. This seemed preferable to omitting two entire days from so small a number. As is generally the case when diurnal inequalities are derived from a limited number of selected days, there was an appreciable non-cyclic element. This was eliminated in the usual way.

The diurnal inequalities resulting for D and H are given in Table IA, p. 238. It will be noticed that the hours are numbered 1 to 24. The reason for this is as follows: The usual practice is to refer diurnal inequalities either to local mean time or to the standard mean time of the country where the observatory is situated. Thus the natural thing would have been to have employed standard New Zealand time, counting hours 1 to 12, a.m. and p.m. But standard New Zealand time is  $11\frac{1}{2}$  hours fast on Greenwich, so that what is a.m. in the one is p.m. in the other. And as G.M.T.—with hours 1 to 12, a.m. and p.m.—was employed in the Christchurch tables in the “Physical Observations,” a similar nomenclature with New Zealand time substituted would have been extremely apt to create confusion. I accordingly decided to employ Greenwich time, but to count the hours 1 to 24, which was really the course proposed in the international term-hour forms. Thus in the tables of this Appendix, hours 6 and 18, for example, are equivalent, respectively, to 5.30 p.m. and 5.30 a.m. New Zealand time. In the discussion a.m. and p.m. mean forenoon and afternoon in New Zealand.

§6. The principal features disclosed by Table IA in the case of Declination are as follows: At all seasons there are two distinct maxima and two distinct minima—distinguished by figures in heavy type. There is thus a distinct double daily oscillation, but the oscillation during the night (say from hours 7 to 19 in Midwinter, and 8 to 17 in Midsummer) is trifling compared to that during the day.

To bring out minute details of the night movements, records would be necessary from a much larger number of days. The extreme westerly position of the needle is reached from 2 to 3 hours before noon. As is usual in the southern hemisphere, the most conspicuous movement during the day is the swing over to the east. The extreme easterly position is reached 2 or 3 hours after noon, and so later than is usual for the corresponding westerly maximum in Britain. As at Kew, the inequality derived from the four equinoctial months closely resembles both in type and range that derived from the whole year. The

ratio borne by the range in Midwinter to that in Midsummer is considerably less than at Kew. The only seasonal variation of type that appears at all marked is that the extreme westerly position is reached earlier in Summer than in Winter.

Horizontal-Force changes, as already stated, were less regular than those of Declination, thus the inequality figures for the former element in Table IA are less smooth than those for the latter. Still, they suffice to bring out the general character clearly. As with D, there is a distinct double daily period, even in Midwinter. The principal minimum is, as at Kew, more conspicuous than the maximum. This minimum occurs near noon—later in the day than at Kew—and it seems some two hours later in Midwinter than in Midsummer. There is a morning maximum some 5 hours before the principal minimum, and a second maximum about 5 p.m., but while the former maximum considerably predominates in Midwinter, the latter is the larger in Midsummer.

The variation in the hour of occurrence of the principal minimum reduces the range in the diurnal inequality for the year, which falls appreciably short of that for the equinoctial months. The difference between the ranges during Midsummer and Midwinter, though well marked, is less conspicuous than in the case of the Declination.

This brief summary will suffice to show the main features of the diurnal variation.

§7. Looking at inequalities such as those in Table IA, and still more so when looking at inequalities based on a very large number of days, one sees a magnetic element rising persistently to a maximum, and falling as steadily to a minimum. But if one takes the more familiar case of a tide in the sea, one knows that while the combination of the observations of a large number of days produces the semblance of continuous rise for hours, followed by continuous fall, on any individual day either rise or fall consists of numerous ebbs and flows in the height, dependent partly on the waves. The number and amplitude of these subsidiary movements may, for all I know, differ widely even on the same day at two spots on the same coast no great distance apart. Very probably the phenomena on any given day are largely dependent on the wind and on the distance of storm centres. Still, I am disposed to think it is probable that the minor phenomena in the rise and fall of the tides in different oceans, or different parts of the same large ocean, possess characteristics of a distinctive character, though these may not be apparent in tidal data calculated in the usual way. Now it is probably the same with the magnetic diurnal variation, with this difference that purely local features have little if any effect. These considerations encouraged the hope that a systematic study of the changes shown by the Christchurch data might disclose phenomena whose comparison with corresponding phenomena at other stations might some day throw a valued light on the nature of the diurnal variation. If similar data should be got out on a future occasion for Christchurch from a year of large sun-spot frequency the comparison could hardly fail to be instructive.

§8. The magnetic changes recorded by ordinary magnetographs rarely if ever occur quite suddenly. Even with slow-run curves the movements usually appear continuous. The fact that the value of H is given on March 1 as  $\cdot 22672$  at 0h. 0m. and as  $\cdot 22671$  at 0h. 3m. does not mean that the value was exactly  $\cdot 22672$  at 0h. 0m., 0h. 1m. and 0h. 2m., but exactly  $\cdot 22671$  at 0h. 3m. Even supposing the photographic trace perfection and the tabulator unerring, it may mean a number of different things. The values at four successive minutes might for instance be

$$\cdot 22672_3, \cdot 22672_0, \cdot 22671_7, \cdot 22671_4,$$

or

$$\cdot 22672_0, 22671_8, \cdot 22671_6, \cdot 22671_4,$$

and there might have been numerous oscillations in value too small to be detected.

The conclusions one would draw as to the number of changes of force occurring in a given time would certainly depend somewhat on the sensitiveness of the instrument, even when one required a given minimum amplitude to count as a change. The number of changes recorded would inevitably vary with the size of the minimum accepted and with the interval between successive readings. On the other hand, I do not think the number of changes in Declination or Horizontal Force (I cannot say the same of Vertical Force) would depend much on the type of the magnetographs (if reasonable damping exists) as distinct from their sensitiveness. In the absence of artificial sources of disturbance, such as persistent air

currents or electric-tram currents, magnets which are properly damped do not get into vibration, and their position at any instant—except during specially violent magnetic storms—may be regarded as one of equilibrium, answering to the instantaneous value of the magnetic field.

§9. Returning now to the term-day data we find very different types of change. Taking, for instance, the Declination changes during the term hours of January 15, February 1, and February 15, 1903 (*see* p. 230), we have a persistent steady rise in Declination from beginning to end of the hour. On the other hand, during the term hours of July 15 and September 15, 1902, p. 229, the Declination went on oscillating through a narrow range without any marked drift in one direction. Then, on August 1, 1902, we have the magnet not budging by as much as 0'·1 from the position it occupied at the beginning of the hour. A consideration of these varied phenomena suggested that account should be taken both of the number of changes and of the range for each hour.

Tables IIA to IVA, pp. 239–241, summarise the results from the readings at 1-minute intervals as to the number of changes in each hour of each term day as derived from the corrected values of the elements, 0'·1 being the minimum change for D, and 1 $\gamma$  the minimum for H and V. In preparing these tables, allowance had to be made for the gaps in the record. This was done on the assumption that changes took place during an interval for which data were lacking at the same average rate as during that part of the same hour for which observations existed. It is these corrected totals that appear in the tables. To show the comparatively trifling character of the uncertainties due to lack of record, the total number of additional changes thus introduced during each day is given in brackets in the last column of each table. With a view to obtaining the diurnal variation in the hourly number of changes, it was also necessary to interpolate values for a few hours—*e.g.* the last two hours of September 15—for which no data existed. These interpolated values—enclosed in brackets—were arrived at by assuming that the ratio which they bore to the total from the remaining hours of the day was the same as for the average day whose records were complete.

§10. Tables VA and VIA, pp. 242–243, summarise the results for the range of Declination and Horizontal Force throughout each hour of each term day. As a rule, no allowance was made for gaps in the record. This was partly because no one guiding principle could be applied, but mainly because there was usually reason to believe that the loss of record had had little, if any, influence on the result. An allowance was, however, made when a gap commencing towards the end of an hour extended into the next hour, and the earliest recorded reading of the second hour lay outside the range covered by the readings during the complete part of the first hour. In such an instance the element was assumed to have increased or diminished, as the case might be, at a uniform rate whilst the trace was lacking. Values were also interpolated for a few hours—*e.g.* the last three hours of September 15—for which readings were totally or largely wanting. These interpolated values are enclosed in brackets; they were arrived at in a similar fashion to the interpolated values in Tables IIA to IVA. The two last columns in Tables VA and VIA give respectively the arithmetical sum of the 24 hourly ranges and the *absolute range*, *i.e.* the difference between the algebraically greatest and least of the readings obtained at 1-minute intervals throughout the day. These absolute ranges are necessarily never less and are usually larger than the ranges on pp. 177 and 178 of the "Physical Observations," which are derived from hourly readings, but the difference is in no case large. On September 15, 1902, and January 15, 1903, there was reason to believe that one of the extreme readings for the day was lost through a break in the readings, so a "+" is put after the range as deduced from the readings recorded.

§11. If we examine Tables IIA and IIIA in detail, we observe a great variability from day to day in the number of changes. On March 15, 1903, there were 426 changes in the Declination reading, or an average of about 18 an hour, though the total range for the day was only 9'·2. On December 1, 1902, and February 1, 1903, with the closely similar absolute ranges of 9'·7 and 8'·9, the numbers of changes were respectively only 244 and 181. The least number of daily changes—averaging about 5½ per hour—was recorded on April 15, 1902, although the absolute range for the day exceeded that on the nine immediately subsequent term days. The greatest number of Declination changes recorded in an hour, *viz.* 41 on March 1, 1903, took place in an early morning hour, for which the normal change due to the regular diurnal inequality was under 0'·2. There are 13 hours in Table IIA during which no change in D was

recorded—all included between 6 p.m. and 4 a.m. Two consecutive hours during which no change was recorded are met with on March 1, 1902, August 1, 1902, and February 1, 1903. The longest interval during which no Declination change as large as  $0\cdot1$  was recorded occurred on August 1, 1902, and amounted to no less than 2 hours 22 minutes. On this day the Declination showed a range of only  $0\cdot1$  between 11h. 45m. and 16h. 3m. (*i.e.* between 11.15 p.m. and 3.33 a.m.). The intervals on March 1 and February 1 during which no change occurred were but little shorter, being on the former occasion 138 minutes (from 1.30 to 3.48 a.m.), and on the latter 133 minutes (from 0.25 to 2.38 a.m.). On March 1 and August 1 there were a few minutes' loss of trace during the intervals specified, but none on February 1.

In the case of H the greatest number of changes in one day took place on November 15, 1902, the day for which Declination data were lacking; the changes averaged nearly 19 an hour, though the absolute range was only  $47\gamma$ . November 15 is, perhaps, the outstanding example of an almost incessant oscillation, the tide of magnetic change never setting in one direction for any length of time. The immediately previous term day, November 1, with exactly the same absolute range, had a number of changes less by nearly 200. The smallest number of changes, 136, occurred on April 15, 1902, the same day as gave the minimum number for D. The greatest number of changes of H in any one hour was 47 on March 15, 1903, the hour representing 4.30 to 5.30 p.m. The range encountered during this hour was only  $8\gamma$ . There are 18 hours in Table IIIA during which no change of H as large as  $1\gamma$  was recorded, and of these seven were included between hours 14 and 16 (*i.e.* 1.30 to 3.30 a.m.).

On August 1 and October 1, 1902, no change in H was recorded during two consecutive hours; on October 15, 1902, during three consecutive hours; and on May 15, 1902, during four consecutive hours. The complete interval without change on this last occasion extended really to 4 hours 41 minutes (from 11.29 p.m. to 4.10 a.m.). Trace, it is true, was lacking for three short periods, amounting in all to 10 minutes, and it is, of course, possible, though unlikely, that a measurable change may thus have failed to be recorded.

In the case of the Vertical Force the number of changes (the minimum change being  $1\gamma$  as with H) showed a maximum of 61 on March 15, 1902, and a minimum of 21 on May 1, 1902. The largest number of changes in one hour, 12, occurred on March 1, 1903, shortly after midnight. No change was recorded during four consecutive hours on June 15, 1902, and February 15, 1903, while on December 15, 1902, no change was recorded during  $5\frac{3}{4}$  hours (from 10.30 p.m. to 4.15 a.m.). The sensitiveness of the H and V magnetographs was for H 1 cm. =  $46\gamma$ , for V 1 cm. =  $27\gamma$ . There is thus nothing in the sensitiveness to account for the extraordinary excess in the number of changes in H. There is, however, some room for doubt whether in the case of V absence of apparent change necessarily meant absolute uniformity in the field. The discontinuities presented on several days are rather suggestive of friction between knife-edge and plane, which might suffice to prevent any response on the part of the magnet to minute oscillations in the field.

If the term days are arranged according to the number of changes of reading, the order is by no means the same for the different elements. This is even more strikingly true as regards individual hours. For example, during hour 5-6 on March 15, 1903, whilst the changes in H numbered 47, those in D and V did not exceed the average. Thus what may fairly be described as "restlessness" by no means always affects the different elements simultaneously. The fluctuations may thus answer for many consecutive minutes, sometimes even for hours, to disturbing forces acting persistently in one general direction.

§12. When comparing the number of changes in D and H it is necessary to remember that the minimum changes, viz.  $0\cdot1$  in D and  $1\gamma$  in H, are arbitrary quantities and do not represent equal disturbances. The force perpendicular to the magnetic Meridian required to produce a change of  $0\cdot1$  in Declination varies as the local value of H. For Christchurch it amounts to  $0\cdot66\gamma$ . Thus the unit for changes in H was really 50 per cent. larger than that for changes in D. The number of changes must decrease as the size of the unit is enlarged, but the exact relationship between the two quantities is uncertain.\* If we

\* Taking June 1 and December 1, the effect was tried of taking  $0\cdot2$  as the unit change in D and  $2\gamma$  as the unit change in H. The number of changes in D was reduced only about 50 per cent., but the number in H was reduced by 70 per cent. The mean of these two days represented fairly average conditions so far as the total number of changes is concerned.

divide the number of observed changes in H by the corresponding number in D multiplied by 0.66 we shall probably overestimate the relative variability in H, while we shall certainly underestimate it if we divide the number for H by the number for D. The results of these two operations are as follows:—

	Year.	Midwinter.	Equinox.	Midsummer.
$\frac{\text{Number of changes in H}}{0.66 \times \text{number of changes in D}} \dots =$	1.67	1.77	1.55	1.67
$\frac{\text{Number of changes in H}}{\text{Number of changes in D}} \dots =$	1.10	1.17	1.02	1.10

If we put the variability in H as 40 per cent. greater than the variability in D, we shall probably not be very far wrong. The figures suggest a seasonal variation in the ratio, but it does not seem to be large. A variation in the ratio would suggest, of course, a seasonal variation in the dominant direction of the disturbing forces.

The tables of hourly ranges call for less comment. If the diurnal variation consisted of a regular single oscillation, the numbers in the penultimate columns of Tables VA and VIA would be approximately double the corresponding numbers in the last columns. The ratio in reality varies within wide limits. In Table VA the largest value of the ratio, 3.6, is met with on the two June term days; in Table VIA the largest value also occurs on June 15 and is no less than 5.4. The largest hourly ranges in D and H occurred respectively on December 15, 1902, and January 1, 1903, being 3.9 for D and 24.7 for H. The smallness of these maxima is eloquent testimony to the remarkable quietness of the term days.

§13. To ascertain more exactly the character of the diurnal variation in the frequency of the changes of reading given by Tables IIA to IVA means were derived for each hour from the first 24 term days, and, in the case of D and H, also from combinations of these days forming the same three seasons as in Table IA. The two term days of March, 1903, were not taken into account.

The results are given in Table VIIA, p. 244, the absolutely largest and least of the hourly values being in heavy type. The penultimate column gives the mean of the 24 hourly values, and so represents the average number of changes of reading per hour for the whole year and the seasons. The last column gives the average number of changes per diem. The number of changes in the case of both D and H is considerably larger at Midsummer than at Midwinter, but the difference between the seasons is much less conspicuous than it is in the case of the range of the diurnal inequality.

In the case of D changes of reading are most numerous close to noon, whilst the magnet is swinging over to the early afternoon maximum of easterly Declination. In the case of H changes of reading are most numerous in the afternoon, either an hour or two before or else an hour or two after the afternoon maximum. In all three elements changes appear to be least numerous in the early morning in the neighbourhood of 4 or 5 a.m. Whilst the day changes are decidedly more numerous than the night, the difference is much less than one would have anticipated from a consideration of the diurnal inequality. Thus if we define "day" as the twelve hours commencing 6 a.m., and assume that half of the entries under hours 7 (6.30 p.m.) and 19 (6.30 a.m.) in Table VIIA belong to the day, while the inequality figures appropriate to 6 a.m. and 6 p.m. are the arithmetic means of those for 18 and 19 and for 6 and 7 respectively, we obtain for the ratios of the day to the night number of changes, and the day to the night inequality ranges, the following values:—

Day/Night.		Year.	Midwinter.	Equinox.	Midsummer.
Number of changes . . . . {	D	1.62	1.22	1.86	1.75
	H	1.31	1.08	1.63	1.25
Inequality ranges . . . . {	D	5.5	5.7	5.8	3.2
	H	5.0	4.5	3.8	8.7

§14. The diurnal variation in the amplitude of the hourly ranges (R) in D and H—as deduced from Tables VA and VIA—is given in Tables VIIIA and IXA, p. 245, for the year and the three seasons; maxima and minima are in heavy type. For comparison, the tables also show the corresponding hourly increments (I), as derived from the mean hourly readings for the year and the seasons, the largest positive and negative increments being in heavy type. These last data differ from the increments derivable from the diurnal inequalities in Table IA only in containing the non-cyclic change which was eliminated in forming the diurnal inequalities. The presence of the non-cyclic element makes only a trifling difference. For example, Table VIIIA gives as the increment in D, for the year as a whole, for the hour ending at 2 the value  $+1'22$ , whereas from the diurnal inequality in Table IA we have  $+3'02 - 1'81$ , or  $+1'21$ .

Before discussing Tables VIIIA and IXA, two anomalous results should be explained, viz., the excess in the I over the R figure for hour 24 for Year and Equinox in Table VIIIA. The excess obviously cannot represent a physical fact, but only an imperfection in the data. It arises from the absence of observational data during one or both of the two last hours of the 24. The hourly readings and the hourly ranges missing were replaced independently by interpolation methods already described. The inconsistency could no doubt have been removed by other methods of interpolation, but it did not seem worth while to take the trouble, as the results would not necessarily have made any nearer approach to real accuracy.

The R and I data in Tables VIIIA and IXA would agree if there were nothing but a regular diurnal inequality with maxima and minima occurring at exact (Greenwich) hours. As a matter of fact, the difference between the two sets of figures in Table VIIIA is very small near the middle of the day, when the Declination inequality change is most rapid. This is due, I think, to more than one cause. During an hour when the inequality change is very rapid any *small* irregular disturbance has no chance of influencing the hourly range, unless it occur near one end of the hour. If, for instance, the normal D change during the hour is a rise of  $2'$ , the minimum value will occur very near the commencement, and the maximum very near the end of the hour, unless there is an irregular disturbance amounting to at least several tenths of a minute. It is thus obvious that the hourly range in D during one of the mid-day hours when the needle is moving rapidly to the east cannot on an ordinary undisturbed day be *much* in excess of the range derived from the hourly readings. This is unquestionably accountable in part for the observed phenomenon, but it cannot, I think, wholly explain it, especially in the Midsummer months, and the conclusion seems warranted that the tendency to an oscillatory, or ebb-and-flow, type of variation in D was at its minimum during the day hours when the regular inequality changes were most rapid.

In the night hours the R and I values differ greatly in both the Tables VIIIA and IXA, in fact there is little relationship between them. It would, however, be incorrect to assume that the R changes owe *nothing* to the diurnal inequality even during an hour when the I change vanishes. The difference between solar and mean time is not wholly negligible in any one of the seasons, still less so in the course of the year, also the times of maxima and minima in the diurnal magnetic inequality vary throughout the year whether we refer them to solar or to mean time. A low I value may mean that the diurnal inequality changes are very slow throughout the whole hour. It may signify, however, that the mean time of occurrence of a maximum or minimum falls about the middle of the hour, the actual time of occurrence varying considerably in different months comprised in the same season. The contributions from different portions of the season to I will then differ in sign, and may largely neutralise one another, but this of course is not the case with their contributions to R. This is unquestionably very largely the cause of the great difference between the R and I figures for some of the day hours, e.g. the hours ending at 22 and 3 (i.e. at 9.30 a.m. and 2.30 p.m.) in Equinox and Year in Table VIIIA. In most of the night hours, however, the difference between the R and I figures must be otherwise explained. In Table IXA there are some day hours, e.g. in Midsummer those ending at 1, 21, and 22, when the R and I figures are very close, but this is exceptional, the differences being on the whole much more conspicuous for H than for D. This is in strict accordance with the greater variability already observed in H, but is not, I think, due exclusively to this cause. If we divide the arithmetic mean of the R by

the arithmetic mean of the I values, as given in the last columns of Tables VIII A and IX A, we find the following values for the ratio:—

	Year.	Midwinter.	Equinox.	Midsummer.
D . . . . .	1·38	1·51	1·30	1·18
H . . . . .	2·16	2·08	1·85	1·63

In the case of D the value thus obtained for the year is less than that for Midwinter, and only a little larger than that for Equinox; but in the case of H the value for the year is larger than even that for Midwinter. This can only be ascribed to variability in the phase of the diurnal inequality, and this greater variability of phase no doubt is partly accountable for the larger excess of the R over the I values in the case of H.

The phenomena presented by 24 days from 12 consecutive months at a particular station may owe a good deal to "accident." Thus it would be a mistake to make sweeping deductions from the Christchurch data discussed here. I trust, however, that the sidelights that have been thrown on the nature of the diurnal variation will at least suggest lines of profitable investigation.



TABLE IA.—Diurnal Inequalities.

Hour . .	1.	2.	3.	4.	5.	6.	7.	8.	9.	10.	11.	12.	13.	14.	15.	16.	17.	18.	19.	20.	21.	22.	23.	24.	Range.	Sum of 24 differences.
<b>DECLINATION.</b> (+ East.)																										
Year . . . .	+ 1'81	+ 3'02	+ 3'28	+ 2'60	+ 1'55	+ 0'83	+ 0'37	+ 0'12	- 0'03	- 0'25	- 0'53	- 0'37	- 0'34	- 0'25	- 0'14	- 0'15	- 0'15	- 0'54	- 1'25	- 2'12	- 2'89	- 2'82	- 1'77	+ 0'08	6'17	27'26
Midwinter . .	+ 0'53	+ 1'55	+ 1'88	+ 1'48	+ 0'55	+ 0'22	+ 0'04	- 0'17	- 0'14	- 0'30	- 0'46	- 0'44	- 0'18	- 0'13	- 0'10	+ 0'04	+ 0'02	0'00	- 0'11	- 0'20	- 0'69	- 1'21	- 1'51	- 0'65	3'39	12'60
Equinox . . .	+ 2'22	+ 3'37	+ 3'32	+ 2'50	+ 1'44	+ 0'73	+ 0'54	+ 0'37	0'00	- 0'23	- 0'53	- 0'26	- 0'36	- 0'22	- 0'28	- 0'25	- 0'26	- 0'46	- 1'08	- 2'15	- 3'16	- 3'35	- 2'05	+ 0'16	6'72	29'29
Midsummer . .	+ 2'76	+ 4'31	+ 4'81	+ 3'97	+ 2'80	+ 1'63	+ 0'55	+ 0'17	- 0'09	- 0'21	- 0'61	- 0'42	- 0'52	- 0'42	- 0'01	- 0'24	- 0'21	- 1'26	- 2'74	- 4'25	- 5'08	- 4'03	- 1'73	+ 0'83	9'89	43'65
<b>HORIZONTAL FORCE.</b> (Unit ly.)																										
Year . . . .	- 12'4	- 6'8	- 0'9	+ 4'2	+ 6'4	+ 5'8	+ 3'5	+ 2'5	+ 2'8	+ 1'9	+ 2'0	+ 3'3	+ 3'1	+ 3'2	+ 3'7	+ 3'5	+ 4'9	+ 6'2	+ 5'6	+ 2'2	- 4'3	- 11'0	- 14'5	- 14'9	21'3	129'6
Midwinter . .	- 11'1	- 10'7	- 9'2	- 4'5	+ 1'8	+ 2'1	+ 1'3	+ 0'7	+ 0'7	+ 0'1	+ 0'5	+ 0'4	+ 1'7	+ 1'9	+ 1'5	+ 1'8	+ 3'0	+ 3'5	+ 4'6	+ 5'6	+ 6'6	+ 4'9	- 0'3	- 6'8	17'7	85'3
Equinox . . .	- 13'4	- 4'8	+ 1'7	+ 5'6	+ 5'5	+ 4'6	+ 4'0	+ 2'0	+ 2'5	+ 0'5	+ 1'5	+ 5'1	+ 4'0	+ 3'7	+ 4'5	+ 4'6	+ 6'0	+ 7'0	+ 6'4	+ 2'4	- 5'8	- 14'2	- 18'0	- 15'4	25'0	143'2
Midsummer . .	- 12'6	- 4'9	+ 4'7	+ 11'5	+ 11'9	+ 10'6	+ 5'3	+ 4'9	+ 5'1	+ 5'1	+ 4'1	+ 4'4	+ 3'8	+ 4'0	+ 5'2	+ 4'0	+ 5'9	+ 8'1	+ 5'9	- 1'5	- 13'8	- 23'8	- 25'3	- 22'6	37'2	209'0

TABLE IIA.—Number of Changes in Declination.

Hour ending . . . . .	1.	2.	3.	4.	5.	6.	7.	8.	9.	10.	11.	12.	13.	14.	15.	16.	17.	18.	19.	20.	21.	22.	23.	24.	Total changes.
<b>1902</b>																									
March 1 . . . . .	18	11	7	14	8	9	17	8	3	10	14	10	4	5	0	0	2	11	15	14	9	12	18	21	240 (15)
„ 15 . . . . .	20	20	9	9	13	14	4	21	26	6	12	16	7	3	15	17	8	2	10	19	17	15	6	15	304 (24)
April 1 . . . . .	16	10	6	15	13	19	18	14	5	14	20	18	21	15	2	0	1	2	5	19	13	12	14	22	294 (15)
„ 15 . . . . .	13	18	3	8	10	6	6	0	4	3	1	1	2	1	1	2	2	2	1	7	11	10	2	17	131 (2)
May 1 . . . . .	19	9	4	7	7	12	7	0	4	9	11	6	2	3	2	6	4	19	7	6	12	9	7	11	183 (5)
„ 15 . . . . .	15	14	13	12	8	3	4	4	4	0	5	4	9	5	4	6	1	2	4	2	8	6	6	7	146 (2)
June 1 . . . . .	14	15	11	12	5	11	16	26	15	14	4	7	8	4	0	6	7	4	4	4	7	3	5	6	208 (6)
„ 15 . . . . .	8	9	3	5	11	5	2	4	4	6	7	16	28	17	4	3	3	11	17	13	6	15	16	19	232 (5)
July 1 . . . . .	8	11	4	7	10	1	2	24	7	1	2	2	4	34	14	1	5	7	7	6	6	10	4	4	181 (10)
„ 15 . . . . .	10	13	11	2	12	10	3	6	5	6	10	9	11	2	1	4	1	2	2	2	5	9	12	18	166 (3)
August 1 . . . . .	11	11	7	3	14	7	2	2	16	17	10	4	0	1	0	0	2	1	1	1	4	9	4	14	141 (2)
„ 15 . . . . .	8	8	7	3	8	8	3	7	7	3	8	6	6	18	6	3	2	1	2	4	4	3	3	6	134 (2)
September 1 . . . . .	17	10	10	7	5	4	5	8	1	3	5	6	0	1	3	3	2	3	3	9	12	4	9	17	147 (1)
„ 15 . . . . .	27	15	11	17	10	9	10	2	8	8	3	3	9	4	4	10	4	2	5	11	11	38	(15)	(21)	257 (64)
October 1 . . . . .	16	4	13	12	17	6	17	10	3	2	9	22	11	7	8	6	8	11	10	12	20	9	15	31	279 (12)
„ 15 . . . . .	16	14	8	11	12	7	3	11	8	2	19	11	3	5	1	2	2	5	15	14	15	5	22	27	238 (6)
November 1 . . . . .	24	9	12	20	17	16	16	7	12	6	21	12	7	3	4	2	5	8	14	13	8	12	18	19	285 (13)
<b>1903</b>																									
January 1 . . . . .	21	14	9	13	15	12	10	10	2	8	4	9	8	4	2	6	11	7	12	17	12	10	31	32	279 (4)
„ 15 . . . . .	7	10	6	5	9	2	6	3	10	15	7	4	8	5	13	6	2	6	12	16	7	7	7	17	190 (17)
February 1 . . . . .	22	16	10	6	9	9	13	4	4	1	2	3	1	0	0	3	2	1	13	15	10	6	17	14	181 (2)
„ 15 . . . . .	20	17	12	11	(11)	11	10	6	6	6	16	11	15	22	26	8	18	29	28	29	18	11	19	20	380 (23)
March 1 . . . . .	12	13	7	13	9	2	2	4	7	14	7	7	7	41	23	22	28	23	26	25	26	13	18	22	371 (9)
„ 15 . . . . .	25	20	6	19	16	9	14	17	25	34	24	17	20	22	33	17	4	1	10	18	36	9	17	13	426 (16)

CHRISTCHURCH TERM-DAY OBSERVATIONS.

TABLE IIIA.—Number of Changes in Horizontal Force.

Hour ending . . . . .	1.	2.	3.	4.	5.	6.	7.	8.	9.	10.	11.	12.	13.	14.	15.	16.	17.	18.	19.	20.	21.	22.	23.	24.	Total changes.
1902																									
March 1 . . . . .	20	12	20	26	21	31	38	19	15	17	21	8	11	8	5	5	9	6	8	10	14	13	14	13	364 (21)
" 15 . . . . .	12	12	19	17	15	15	17	15	24	8	18	8	4	9	15	9	6	2	5	7	10	11	6	6	270 (24)
April 1 . . . . .	15	12	11	24	17	28	14	27	7	18	8	13	26	10	7	4	4	8	5	6	9	12	6	11	302 (14)
" 15 . . . . .	4	6	9	2	11	11	11	3	3	5	2	2	5	11	6	4	3	3	6	4	4	6	4	11	136 (5)
May 1 . . . . .	13	4	9	8	11	19	2	21	14	4	14	1	2	1	6	0	4	9	3	4	7	9	8	10	183 (5)
" 15 . . . . .	5	15	29	14	10	7	1	8	2	3	3	4	0	0	0	0	2	6	3	1	5	3	12	9	142 (9)
June 1 . . . . .	18	12	25	19	10	11	15	20	14	10	5	7	5	3	9	0	5	1	6	6	4	5	4	8	222 (10)
" 15 . . . . .	9	4	10	18	9	6	8	11	6	4	13	25	35	30	17	20	5	15	19	22	19	11	9	20	345 (8)
July 1 . . . . .	9	6	7	21	11	3	4	12	2	8	8	7	5	24	7	4	3	4	1	5	5	5	7	7	175 (6)
" 15 . . . . .	4	10	16	18	15	11	4	18	11	15	22	9	3	2	3	3	3	4	4	5	6	4	11	19	220 (4)
August 1 . . . . .	8	14	0	4	17	1	0	3	27	30	22	15	13	7	4	1	2	3	0	0	3	2	8	4	188 (5)
" 15 . . . . .	5	5	2	8	9	11	15	11	11	13	15	5	3	4	4	2	2	1	0	1	3	3	10	11	154 (3)
September 1 . . . . .	11	21	11	14	15	14	6	5	7	3	5	6	3	1	0	7	12	3	2	6	6	10	14	22	204 (3)
" 15 . . . . .	14	25	18	26	7	14	18	0	2	18	13	7	6	8	12	1	1	1	3	5	9	22	(10)	(11)	251 (42)
October 1 . . . . .	17	22	26	16	22	12	16	10	4	5	2	4	5	5	3	2	5	0	0	4	8	8	9	12	217 (9)
" 15 . . . . .	12	11	9	5	13	17	18	10	14	10	12	11	2	2	0	0	0	1	4	7	10	9	5	5	187 (3)
November 1 . . . . .	20	30	16	23	20	17	12	4	13	10	22	5	2	4	5	2	3	9	5	8	11	9	2	6	258 (11)
" 15 . . . . .	19	13	17	35	36	21	26	18	9	38	28	15	15	23	15	11	11	10	15	8	18	17	24	7	449 (19)
December 1 . . . . .	9	19	10	11	5	12	24	7	2	10	26	12	46	12	14	7	14	9	7	12	8	9	8	14	307 (7)
" 15 . . . . .	19	21	29	19	6	7	6	6	12	10	7	7	9	6	5	5	4	3	8	10	14	9	22	11	255 (5)
1903																									
January 1 . . . . .	13	17	23	9	11	16	19	22	26	6	3	8	4	11	2	8	20	5	10	3	14	22	16	14	302 (10)
" 15 . . . . .	18	16	11	11	20	20	17	8	14	20	4	14	11	12	11	4	8	3	3	10	13	6	9	7	270 (26)
February 1 . . . . .	4	7	13	7	15	15	6	8	7	2	4	1	1	4	4	2	1	11	9	9	12	5	10	7	164 (4)
" 15 . . . . .	19	21	26	15	(11)	7	11	17	15	15	14	14	15	22	15	11	24	8	12	11	15	10	2	7	337 (20)
March 1 . . . . .	3	14	12	9	1	6	22	10	12	14	18	9	12	35	17	17	24	25	17	11	19	12	17	18	354 (6)
" 15 . . . . .	19	11	27	11	31	47	27	4	25	19	7	11	18	4	23	5	15	11	7	7	11	13	9	8	370 (12)

TABLE IVA.—Number of Changes in Vertical Force.

Hour ending . . . . .	1.	2.	3.	4.	5.	6.	7.	8.	9.	10.	11.	12.	13.	14.	15.	16.	17.	18.	19.	20.	21.	22.	23.	24.	Total changes.	
1902																										
March 1 . . . . .	1	1	2	1	4	5	8	3	3	5	0	5	2	0	0	2	2	2	3	1	2	1	1	4	58 (1)	
" 15 . . . . .	2	0	2	6	2	2	6	5	1	3	4	6	1	1	6	0	1	4	1	2	2	1	2	1	4	61 (3)
April 1 . . . . .	1	0	4	1	0	4	2	4	6	1	4	3	6	2	2	3	0	0	2	0	2	0	0	0	0	47 (1)
" 15 . . . . .	0	3	1	1	1	1	2	0	2	2	0	1	0	3	3	0	1	2	0	2	3	0	2	0	0	30
May 1 . . . . .	0	3	0	0	1	2	0	2	1	1	2	2	1	1	0	0	1	1	0	1	1	0	0	1	0	21
" 15 . . . . .	2	2	2	1	3	0	3	0	0	1	0	1	0	2	0	0	1	2	0	0	1	0	2	0	0	23
June 1 . . . . .	1	0	2	2	1	1	2	5	1	4	1	2	2	2	3	1	1	1	2	1	1	2	1	2	1	41 (2)
" 15 . . . . .	2	2	1	1	1	0	2	0	0	0	0	3	2	6	0	2	3	0	2	2	2	0	2	2	2	35
July 1 . . . . .	2	2	1	1	3	1	1	4	2	1	0	1	4	5	0	1	1	2	2	0	1	3	2	1	1	41 (2)
" 15 . . . . .	1	1	0	2	2	0	2	3	3	2	1	1	1	0	2	1	2	1	0	2	3	1	2	2	2	35
August 1 . . . . .	1	1	1	3	2	0	3	3	2	1	2	1	0	1	2	2	2	2	0	1	0	1	2	1	1	34
" 15 . . . . .	1	3	0	1	2	5	1	0	3	2	1	0	0	3	3	1	0	0	1	0	2	2	0	0	0	31
September 1 . . . . .	3	2	1	3	4	1	0	0	1	0	0	2	0	1	3	0	2	4	0	1	3	2	2	2	2	37
" 15 . . . . .	2	2	1	0	1	1	0	2	1	2	3	1	1	1	2	3	0	1	1	0	0	0	(1)	(1)	27 (2)	
October 1 . . . . .	4	5	7	4	1	3	0	2	3	1	1	0	2	1	0	0	0	3	1	3	0	2	2	5	0	50 (1)
" 15 . . . . .	1	0	2	1	2	3	1	1	1	1	0	4	5	3	1	0	0	1	2	3	1	2	5	0	0	40
November 1 . . . . .	2	0	2	0	5	1	0	0	1	1	2	3	0	1	1	1	0	1	1	2	0	2	(1)	0	0	27 (2)
" 15 . . . . .	2	2	2	5	2	3	0	1	0	1	1	0	2	5	2	1	0	1	1	0	3	3	3	1	1	41 (1)
December 1 . . . . .	0	1	2	2	1	0	1	0	3	1	2	1	0	2	3	1	0	4	1	2	7	1	2	2	2	39
" 15 . . . . .	0	3	6	(3)	1	1	2	2	1	1	1	0	0	0	0	0	1	2	1	2	2	2	5	1	1	37 (3)
1903																										
January 1 . . . . .	2	1	2	2	3	3	0	3	3	1	1	1	0	2	0	0	2	0	0	2	1	3	3	3	3	38
" 15 . . . . .	1	2	3	1	0	2	0	0	3	5	4	0	3	1	0	0	0	1	2	1	1	0	1	2	2	33 (3)
February 1 . . . . .	2	2	2	0	0	1	1	2	1	1	1	0	1	0	0	2	0	4	1	4	3	0	0	2	0	30
" 15 . . . . .	3	2	1	0	(1)	1	0	1	1	0	0	0	0	1	2	3	2	1	1	4	3	1	1	0	0	29 (1)
March 1 . . . . .	1	2	6	0	2	1	0	0	3	0	0	0	1	12	4	3	2	3	1	3	4	0	1	0	0	49 (1)
" 15 . . . . .	5	1	1	4	7	2	0	1	3	3	1	1	1	1	3	0	0	3	0	2	2	2	1	0	0	44

21

CHRISTCHURCH TERM-DAY OBSERVATIONS.

TABLE VA.—Hourly Ranges in Declination. (Unit 0'.1.)

Hour ending . . . . .	1.	2.	3.	4.	5.	6.	7.	8.	9.	10.	11.	12.	13.	14.	15.	16.	17.	18.	19.	20.	21.	22.	23.	24.	Sum of hourly ranges.	Absolute daily range.
1902																										
March 1 . . . . .	21	11	5	5	8	11	5	4	1	8	6	6	2	1	0	0	1	6	16	16	9	10	21	22	195	85
„ 15 . . . . .	22	17	6	9	14	15	1	7	10	4	5	5	4	2	8	6	4	1	9	14	10	8	11	21	213	88
April 1 . . . . .	26	11	3	10	15	15	9	4	2	12	9	10	17	9	1	0	1	1	2	9	14	10	11	24	225	73
„ 15 . . . . .	15	18	2	9	10	3	3	0	5	2	1	1	2	1	1	1	1	1	1	6	12	12	3	9	119	62
May 1 . . . . .	21	10	3	6	7	7	5	0	4	6	4	4	1	2	3	4	2	6	7	5	12	7	5	13	144	51
„ 15 . . . . .	17	15	6	10	9	2	3	2	5	0	4	3	5	5	4	4	1	1	2	2	10	6	6	9	131	51
June 1 . . . . .	14	9	5	8	4	6	8	13	11	9	1	3	8	1	0	2	7	3	3	2	2	3	3	4	129	36
„ 15 . . . . .	8	10	1	4	14	4	2	1	2	3	4	6	9	13	2	1	1	4	5	3	2	6	3	11	119	33
July 1 . . . . .	7	12	3	8	11	1	1	9	4	1	2	1	3	9	5	1	3	4	3	3	6	9	4	4	114	37
„ 15 . . . . .	8	14	9	2	13	4	2	2	3	4	5	1	3	2	1	2	1	1	1	1	2	4	6	9	100	31
August 1 . . . . .	12	12	7	3	13	8	1	1	8	6	2	2	0	1	0	0	2	1	1	1	4	10	4	16	115	45
„ 15 . . . . .	9	9	8	3	6	6	2	3	4	2	6	3	3	4	2	3	1	1	1	1	5	3	9	6	100	34
September 1 . . . . .	19	7	5	4	2	1	5	9	1	3	4	4	0	2	3	4	3	1	3	11	13	2	8	20	134	46
„ 15 . . . . .	30	14	9	10	11	6	5	1	4	3	2	1	3	2	2	3	3	1	6	11	7	(8)	(12)	(17)	171	65+
October 1 . . . . .	17	5	8	13	13	5	7	9	2	2	7	9	7	2	3	2	4	5	7	10	8	7	17	23	192	70
„ 15 . . . . .	18	16	8	12	13	7	3	5	6	2	15	12	1	4	1	1	1	5	6	12	12	4	23	31	218	79
November 1 . . . . .	11	12	5	9	11	11	9	5	5	5	13	11	5	2	2	1	4	8	16	12	5	11	20	(20)	213	83
December 1 . . . . .	14	16	11	5	11	11	14	5	2	1	5	8	9	3	11	8	4	12	14	9	3	12	25	27	240	97
„ 15 . . . . .	30	15	6	10	19	19	17	5	3	5	4	6	3	3	2	2	6	11	15	11	9	19	23	39	282	117
1903																										
January 1 . . . . .	24	15	6	14	14	13	9	11	3	2	2	4	3	2	1	2	12	7	14	22	13	5	36	38	272	140
„ 15 . . . . .	8	12	7	6	6	3	6	2	12	9	(6)	(5)	8	4	4	5	2	6	13	19	8	(9)	(14)	20	194	66+
February 1 . . . . .	27	19	12	7	10	11	17	5	5	1	1	1	1	0	0	2	1	2	14	18	9	8	19	16	206	89
„ 15 . . . . .	22	22	5	8	(12)	(15)	8	5	4	5	18	9	4	7	27	9	20	28	23	17	15	10	22	21	336	110
March 1 . . . . .	14	16	3	8	9	2	3	3	2	6	4	1	3	26	7	5	20	11	12	19	11	5	22	21	233	73
„ 15 . . . . .	27	12	5	21	21	8	4	5	16	8	6	4	14	13	13	8	1	1	11	16	11	2	32	13	272	92

TABLE VIA.—Hourly Ranges in Horizontal Force. (Unit 1γ.)

Hour ending . . . . .	1.	2.	3.	4.	5.	6.	7.	8.	9.	10.	11.	12.	13.	14.	15.	16.	17.	18.	19.	20.	21.	22.	23.	24.	Sum of hourly ranges.	Absolute daily range.
1902																										
March 1 . . . . .	4	14	9	9	6	6	8	10	4	5	6	3	4	3	1	4	3	1	5	8	14	9	3	6	145	49
" 15 . . . . .	5	8	13	14	7	5	2	10	15	2	7	4	2	5	7	5	3	2	4	7	10	9	4	3	153	48
April 1 . . . . .	7	10	9	8	4	11	3	13	5	7	2	21	10	5	3	2	3	1	2	4	8	10	6	5	159	37
" 15 . . . . .	2	4	5	1	6	5	2	2	2	2	2	2	2	3	3	2	1	2	3	2	4	6	4	5	72	22
May 1 . . . . .	7	1	3	6	7	4	1	3	3	2	5	1	1	1	2	0	1	5	3	2	3	7	8	8	84	28
" 15 . . . . .	5	5	4	7	7	2	1	1	2	1	1	2	0	0	0	0	1	1	2	1	4	3	2	5	57	24
June 1 . . . . .	10	3	5	4	9	5	7	5	6	6	3	3	4	2	3	0	1	1	3	3	2	3	4	4	96	23
" 15 . . . . .	5	1	3	8	4	1	2	3	1	2	6	9	16	22	5	5	5	5	5	2	2	3	2	8	125	23
July 1 . . . . .	2	6	1	7	10	1	3	3	1	3	2	3	2	6	3	1	2	3	1	1	3	5	6	8	83	22
" 15 . . . . .	4	8	5	7	8	5	2	5	6	8	10	3	1	1	1	2	3	2	2	3	5	2	11	11	115	26
August 1 . . . . .	2	1	0	4	4	1	0	1	4	2	2	2	1	1	1	1	2	1	0	0	2	2	8	5	47	16
" 15 . . . . .	5	3	1	4	4	5	2	2	2	3	5	2	1	1	2	1	1	1	0	1	3	3	3	7	62	17
September 1 . . . . .	4	13	7	5	4	4	2	2	4	1	2	3	1	1	0	4	3	2	2	2	5	10	12	4	97	34
" 15 . . . . .	6	13	5	10	4	6	5	0	1	6	6	3	2	4	3	1	1	1	1	3	7	(7)	(5)	(6)	106	31+
October 1 . . . . .	3	8	8	7	8	4	3	2	3	2	2	2	3	2	2	1	4	0	0	5	9	8	5	17	108	23
" 15 . . . . .	5	11	7	4	3	6	3	3	6	4	4	6	1	1	0	0	0	1	3	3	10	9	4	5	99	40
November 1 . . . . .	16	10	8	9	8	7	7	2	4	3	5	5	1	1	3	1	1	4	1	7	11	8	1	(5)	128	47
" 15 . . . . .	17	9	10	20	15	5	14	5	4	5	9	5	6	7	7	6	5	4	6	4	18	13	3	4	201	47
December 1 . . . . .	8	16	11	7	1	8	3	2	1	2	9	5	6	7	6	3	6	6	3	11	8	7	5	8	149	43
" 15 . . . . .	8	10	10	10	3	3	6	2	4	2	2	2	3	2	2	2	4	2	8	10	13	7	6	7	128	46
1903																										
January 1 . . . . .	7	14	24	5	5	4	10	4	4	2	1	3	2	2	2	4	3	5	3	2	14	21	10	6	157	56
" 15 . . . . .	14	3	3	4	4	4	6	6	3	3	(5)	(5)	5	5	3	4	4	2	3	10	13	(6)	(6)	7	130	46+
February 1 . . . . .	2	7	13	7	3	3	3	3	1	1	1	1	1	3	2	1	1	5	3	9	9	5	4	3	91	32
" 15 . . . . .	10	3	11	10	(6)	(3)	5	4	5	4	6	4	4	4	6	5	14	5	4	9	12	11	1	3	149	51
March 1 . . . . .	2	14	10	8	1	4	3	3	5	2	3	3	2	8	3	4	7	6	8	5	10	12	12	8	143	46
" 15 . . . . .	9	11	9	4	11	8	5	2	5	3	2	2	6	2	9	5	2	2	4	6	11	11	4	6	139	46

212

CHRISTCHURCH TERM-DAY OBSERVATIONS.

TABLE VIIA.—Diurnal Variation in Hourly Number of Changes.

Hour ending . . . . .	1.	2.	3.	4.	5.	6.	7.	8.	9.	10.	11.	12.	13.	14.	15.	16.	17.	18.	19.	20.	21.	22.	23.	24.	Mean per hour.	Mean per diem.
<b>DECLINATION.</b>																										
Year . . . . .	16·0	12·4	8·5	9·2	11·0	9·1	8·7	8·2	7·1	6·7	8·8	8·4	8·1	7·5	5·5	4·6	4·5	6·9	9·3	11·4	10·0	10·6	12·5	18·1	9·30	223
Midwinter . . . . .	11·6	11·2	7·5	6·4	9·4	7·1	4·9	9·1	7·8	7·0	7·1	6·8	8·5	10·5	3·9	3·6	3·1	5·9	5·5	4·8	6·5	8·0	6·5	10·6	7·22	173
Equinox . . . . .	17·9	12·8	8·4	11·6	11·0	9·3	10·0	9·2	7·3	6·0	10·4	10·9	7·1	5·1	4·2	5·0	3·6	4·8	8·0	13·1	13·5	13·1	12·6	21·4	9·85	236
Midsummer . . . . .	19·0	13·4	9·7	9·7	12·7	11·1	11·7	6·0	6·1	7·3	9·0	7·4	8·9	6·9	8·9	5·1	7·0	10·4	15·3	17·1	10·1	10·6	19·3	22·9	11·07	266
<b>HORIZONTAL FORCE.</b>																										
Year . . . . .	12·4	14·0	15·2	15·4	14·0	13·6	12·8	11·8	10·9	11·7	12·1	8·7	9·6	9·1	7·0	4·7	6·3	5·2	5·8	6·8	9·5	9·2	9·6	10·5	10·25	246
Midwinter . . . . .	8·9	8·8	12·2	13·7	11·5	8·6	6·1	13·0	10·9	10·9	12·8	9·1	8·2	8·9	6·2	3·8	3·3	5·4	4·5	5·5	6·5	5·3	8·6	11·0	8·49	204
Equinox . . . . .	13·1	15·1	15·4	16·2	15·1	17·7	17·3	11·1	9·5	10·5	10·1	7·4	7·8	6·8	6·0	4·0	5·0	3·0	4·1	6·1	8·8	11·4	8·5	11·4	10·06	241
Midsummer . . . . .	15·1	18·0	18·1	16·2	15·5	14·4	15·1	11·3	12·2	13·9	13·5	9·5	12·9	11·7	8·9	6·3	10·6	7·3	8·6	8·9	13·1	10·9	11·6	9·1	12·20	293
<b>VERTICAL FORCE.</b>																										
Year . . . . .	1·5	1·7	2·0	1·7	1·8	1·7	1·5	1·8	1·8	1·6	1·3	1·6	1·4	1·8	1·5	1·0	0·9	1·7	1·0	1·5	1·8	1·2	1·7	1·4	1·54	37

TABLE VIII.—Hourly Ranges (R) and Hourly Increments (I) of Declination (Diurnal Variation).

Hour ending . .		1.	2.	3.	4.	5.	6.	7.	8.	9.	10.	11.	12.	13.	14.	15.	16.	17.	18.	19.	20.	21.	22.	23.	24.	Mean.
Year . . . . .	R	1.74	1.31	0.61	0.76	1.07	0.80	0.62	0.47	0.46	0.41	0.55	0.50	0.44	0.35	0.36	<b>0.27</b>	0.37	0.50	0.79	0.93	0.83	0.80	1.33	<b>1.83</b>	0.754
	I	+1.74	+1.22	+0.27	-0.67	-1.03	-0.71	-0.45	-0.24	-0.14	-0.20	-0.27	+0.17	+0.04	+0.10	+0.13	0.00	+0.01	-0.38	-0.70	-0.85	-0.76	+0.08	+1.06	+1.87	0.546
Midwinter . .	R	1.20	1.14	0.53	0.55	0.96	0.48	0.30	0.39	0.51	0.39	0.35	0.29	0.40	0.46	<b>0.21</b>	<b>0.21</b>	0.23	0.26	0.29	0.23	0.54	0.60	0.50	0.90	0.496
	I	+1.19	+1.01	+0.34	-0.40	-0.92	-0.34	-0.18	-0.21	+0.03	-0.16	-0.16	+0.03	+0.28	+0.05	+0.03	+0.15	-0.02	-0.01	-0.11	-0.09	-0.49	-0.52	-0.30	+0.86	0.328
Equinox . . .	R	2.10	1.24	0.57	0.90	1.07	0.79	0.48	0.49	0.39	0.45	0.61	0.60	0.45	0.29	0.24	<b>0.21</b>	0.23	0.26	0.62	1.11	1.06	0.76	1.32	2.09	0.764
	I	2.09	1.16	-0.03	-0.80	-1.04	-0.69	-0.16	-0.15	-0.22	-0.34	-0.27	+0.29	-0.07	+0.16	-0.04	+0.05	+0.01	-0.17	-0.60	-1.05	-0.99	-0.16	+1.31	+2.24	0.587
Midsummer . .	R	1.94	1.59	0.74	0.84	1.19	1.19	1.14	0.54	0.49	0.40	0.70	0.63	0.47	<b>0.30</b>	0.67	0.41	0.70	1.06	1.56	1.54	0.89	1.06	2.27	<b>2.59</b>	1.037
	I	+1.94	+1.56	+0.51	-0.83	-1.16	-1.16	-1.07	-0.37	-0.24	-0.11	-0.39	+0.20	-0.09	+0.11	+0.41	-0.21	+0.04	-1.04	-1.47	-1.50	-0.81	+1.06	+2.31	+2.57	0.882

TABLE IXA.—Hourly Ranges (R) and Hourly Increments (I) of Horizontal Force (Diurnal Variation). (Unit 1γ.)

Hour ending . .		1.	2.	3.	4.	5.	6.	7.	8.	9.	10.	11.	12.	13.	14.	15.	16.	17.	18.	19.	20.	21.	22.	23.	24.	Mean.
Year . . . . .	R	6.6	7.5	7.3	7.4	5.8	4.5	4.2	3.9	3.8	3.3	4.3	4.1	3.3	3.7	2.8	<b>2.3</b>	3.0	2.6	2.8	4.5	<b>7.9</b>	7.3	5.1	6.2	4.76
	I	+2.6	+5.6	+5.9	+5.2	+2.2	-0.6	-2.2	-1.0	+0.3	-0.9	+0.2	+1.3	-0.1	+0.1	+0.5	-0.2	+1.5	+1.3	-0.5	-3.4	-6.5	-6.7	-3.5	-0.4	2.20
Midwinter . .	R	5.0	3.5	2.8	5.9	6.6	3.0	2.3	2.9	3.1	3.4	4.2	3.1	3.2	4.2	2.1	1.3	2.0	2.4	2.0	1.6	3.0	3.5	5.5	7.0	3.48
	I	-4.4	+0.4	+1.4	+4.6	+6.2	+0.3	-0.9	-0.6	0.0	-0.7	+0.4	-0.1	+1.2	+0.1	-0.5	+0.3	+1.1	+0.5	+1.0	+1.0	+0.9	-1.8	-5.2	-6.5	1.67
Equinox . . .	R	4.5	<b>10.1</b>	7.9	7.2	5.3	5.9	3.5	5.2	5.0	3.6	3.9	5.5	3.1	3.0	2.4	2.4	2.2	<b>1.3</b>	2.5	4.3	8.4	8.5	5.4	6.4	4.89
	I	+2.0	+ <b>8.6</b>	+6.5	+3.9	-0.1	-0.9	-0.6	-2.0	+0.5	-2.0	+1.0	+3.5	-1.1	-0.2	+0.7	+0.1	+1.4	+1.0	-0.6	-4.0	-8.2	- <b>8.4</b>	-3.8	+2.5	2.65
Midsummer . .	R	10.2	9.0	11.2	9.0	5.6	4.6	6.7	3.5	3.2	<b>2.8</b>	4.7	3.8	3.5	3.9	3.9	3.3	4.7	4.1	3.9	7.7	<b>12.2</b>	10.0	4.5	5.4	5.90
	I	+10.1	+7.9	+9.7	+7.0	+0.5	-1.1	-5.1	-0.3	+0.4	+0.1	-0.9	+0.5	-0.5	+0.4	+1.4	-1.0	+2.0	+2.4	-2.0	-7.3	- <b>12.1</b>	-9.9	-1.4	+2.9	3.62



## APPENDIX B.

An Examination of Antarctic disturbances from October, 1902, to March, 1903, which are simultaneous with Arctic disturbances discussed by Prof. KR. BIRKELAND.

§1. AFTER the discussion of the Antarctic magnetic data on pages 73 to 200 had been completed, there appeared a large volume by Prof. KR. BIRKELAND\* which contains a great mass of information respecting magnetic disturbances in the Arctic, from October, 1902, to March, 1903, which were contemporaneous with the observations discussed in this volume.

Prof. BIRKELAND had the following four Arctic stations, all provided with self-recording magnetographs:—

Station.	Latitude N.	Longitude.
	° /	° /
Axelöen (Spitzbergen) . . . . .	77 41	14 50 E
Matotchkin Schar (Nova Zembla) . . . . .	73 17	53 57 E
Kaafjord (Finmark) . . . . .	69 56	22 58 E
Dyrafjord (Iceland) . . . . .	66 15	22 30 W

Guided by the records from these stations and from Potsdam, Prof. BIRKELAND made a list of disturbances and issued a circular to magnetic observatories requesting copies of the records obtained on the days specified on his list. He thus became possessed of records of disturbances at 25 stations, including the four mentioned above and the following:—

In Europe—Bossekop, Pawlowsk, Stonyhurst, Wilhelmshaven, Potsdam, Kew, Val Joyeux, Munich, Pola, San Fernando; in Asia—Tiflis, Zi-ka-wei, Dehra Dun, Bombay, Batavia; in N. America—Sitka, Toronto, Baldwin, Cheltenham; in the Pacific—Honolulu and Christchurch. The names in each group are in order of latitude from north to south.

BIRKELAND reproduces the disturbed curves in 21 plates, each dealing with a disturbed period varying in length from 2 to 20 hours. Some of the observatories supplied no Vertical-Force curves, and only a few supplied material for all the magnetic storms. Still, the plates represent what is probably the most extensive series of contemporaneous magnetic data that has yet been published. In addition to the plates, the volume contains over 160 charts representing the results which BIRKELAND has deduced for the disturbing forces at the different stations, at different stages of the 21 storm periods. These charts are based on elaborate measurements of the magnetic curves and represent a large amount of work. Besides discussing the charts, BIRKELAND deals with experiments which he has made with a miniature Earth, or terrella, magnetised and exposed to kathode-ray discharges in a high vacuum. The experiments are intended to serve as an auxiliary to the elucidation of the causes that produce magnetic disturbances. The discussion of observations, experiments and theory occupies more than 300 large quarto pages.

§2. As already mentioned, the discussion originally contemplated of Antarctic magnetic storms had been entirely completed when Prof. BIRKELAND'S volume came into my hands in February, 1909, and I was exceedingly reluctant to re-open the subject, considering the long time that had already elapsed since the work was begun. It was accordingly decided that no change should be made in what had been already written, and pages 73 to 200 are thus absolutely unaffected by any results or views in BIRKELAND'S† volume. When Prof. BIRKELAND'S conclusions and mine harmonize, the harmony thus merits increased consideration; when they differ, the difference at least owes nothing to prejudice.

\* 'The Norwegian Aurora Polaris Expedition, 1902-1903,' Volume I.

† The reference in Chapter IX is to Prof. BIRKELAND'S earlier work, 'Expédition Norvégienne de 1899-1900.'

After having read Prof. BIRKELAND'S volume, I came, somewhat reluctantly I must confess, to the conclusion that those responsible for the production of the present volume would be open to criticism if the opportunity afforded for contrasting Arctic and Antarctic records were not utilised. This appendix has accordingly been written with the object of supplying information as to what was happening in the Antarctic during the disturbed times selected by Prof. BIRKELAND. Its primary object is to inform, not to criticise, and if it contains anything that savours of criticism, this is mainly in order to explain why Prof. BIRKELAND'S exact procedure has not been followed.

§3. The method adopted by BIRKELAND in dealing with magnetic disturbances is fundamentally different from that adopted in Chapters IX and X. Practically following SABINE, he defines disturbance at any given hour as the difference from the *normal* for that hour; and what his tables give, and his charts illustrate, are the values of disturbances so defined at different stages of each disturbed period. He believes that the cause of the disturbance is an electrical discharge, or a series of electrical discharges, in the Earth's atmosphere, such as he has succeeded in producing in the vicinity of his terrella, and his ultimate object apparently is to calculate the position and intensity of these discharges.

One great difficulty, as I remarked in §90, Chapter IX, is the fixing of a *normal* value. In doing this BIRKELAND seems to have been materially helped by the fact that at some observatories, including those provided with Kew-pattern magnetographs, it is usual to have two days' curves on the same photographic sheet. If the one day's curve happens to be undisturbed, its form greatly assists the eye in deciding as to the nature of the disturbance in the other. This is an advantage which I have often had occasion to appreciate myself. The Arctic stations, however, and some of the others had magnetographs of the Eschenhagen pattern, like those of the "Discovery," and there must have been considerable difficulty at times, as BIRKELAND himself allows, in deciding what the departure from the normal really was. This difficulty had probably a considerable indirect influence on BIRKELAND'S choice of disturbance periods. Those he has selected are largely represented at Kew and other non-polar stations by "bays" of comparatively short duration.

What is meant by a "bay" will be readily grasped by reference to the accompanying figure. The

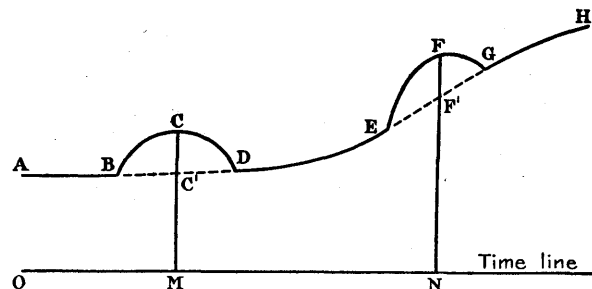

continuous line ABCDEFGH represents an imaginary magnetic curve having two bays, one, BCD, occurring at a time when the regular diurnal variation is slow, the other, EFG, occurring at a time when it is rapid. The ordinates CM, FN drawn on to the base line represent the excess above the constant base-line value of the values of the magnetic element answering to the times M and N. The broken lines BC'D, EF'G are intended to represent the imaginary undisturbed curve, and the intercepts CC', FF' on the ordinates represent from BIRKELAND'S point of view the disturbances.

In such a case as that represented by the figure the method appears simple, especially when the disturbance occurs at a time when the diurnal change is slow. In practice, however, there is usually a difficulty in deciding where the "bay" begins or ends, and the relative position of its two extremities is usually not quite what one would anticipate from the trend of the curve prior to its commencement. This latter difficulty naturally increases the longer the duration of the bay, and the more rapid the regular diurnal inequality changes at the hour.

As a general rule, during really active magnetic disturbances, whilst bays of a kind are not infrequent, the curve adjacent to them is itself disturbed and sinuous, and affords very imperfect guidance as to where the normal curve would come. On days of real disturbance, one is usually obliged to have recourse to the

curves of adjacent days, if quiet, or to a regular diurnal variation derived from a number of days. The latter alternative is, of course, the more satisfactory theoretically ; but there is this difficulty, which I have dealt with elsewhere, that the regular diurnal inequality which one gets depends on the nature of the days from which it is derived. For instance, taking means from 11-year results at Kew, the departure from the mean Declination for the day at 2 p.m. on a representative January day is :—

- + 2'·21 on the Astronomer Royal's selected *quiet* days,
- + 2'·66 on ordinary undisturbed days,
- + 4'·88 on the average highly disturbed day.

For simplicity, we may suppose the secular change and sun-spot influence non-existent, though in reality these are complications which have to be reckoned with. Let us suppose that on a certain disturbed day in January the Declination at 2 p.m. departs from the mean for the month by +3'·66. Is the "disturbance" +1'·45, +1'·00, or -1'·22? The +4'·88 departure from the daily mean on the representative disturbed day in January, be it noted, represents a regular diurnal inequality, or at all events something which we have no present means of distinguishing from a regular inequality. Its excess over the ordinary day value may, of course, indicate a tendency for a particular phase of disturbance to occur at a particular hour of the day, but it may mean that the causes operative in producing the regular diurnal inequality are for some reason—*e.g.*, increased conductivity in the upper atmosphere—more effective on disturbed days than others.

This source of uncertainty is equally present when the normal curve is derived, as BIRKELAND seems to have derived it, by reference to a day or days adjacent to the disturbed one. The adjacent days may be of the very quietest type, or may themselves be considerably disturbed.

There is a further complication in that disturbance has sometimes a tendency to be associated with a temporary alteration in the value of magnetic elements, which disappears gradually like after-strain in a metal. Horizontal Force, for instance, is sometimes very considerably depressed for days after a really large disturbance. Thus it may make all the difference in the world to one's decision as to whether at a particular hour the element is above or below the normal value, if one happens to take for comparison the day after a disturbance rather than the day before. In one instance I observe that Prof. BIRKELAND noticed the occurrence of this precise source of uncertainty.

In the case of the Antarctic curves, the uncertainties which exist elsewhere are mostly much enhanced. We have seen in Chapter III, Tables XII and XIV, that disturbance exerts an unusually marked influence on the amplitude of the regular diurnal inequality. The Antarctic D and H curves were always sensibly disturbed, and the disturbance was usually sufficient to obscure, if not to totally conceal from the eye, the trend of the natural diurnal variation. The diurnal variation of V would very likely have been readily recognisable if the scale-value had been as low as 5γ throughout, and the temperature coefficient had been small ; but, as matters stand, mere optical inspection of the curve tells merely whether disturbance has been specially active or not. The days of Prof. BIRKELAND'S choice lay entirely in the months October, 1902, to March, 1903, and so came in the Antarctic Summer, when the magnetic variations and the temperature changes in the hut were both at their maximum.

§4. There is a rather different kind of uncertainty to which BIRKELAND refers more than once, *e.g.* p. 64, viz., the uncertainty in the estimate of the hour at which a particular movement took place. When one is dealing with stations not too far apart, especially when furnished with magnetographs of the same type—such, for instance, as Stonyhurst, Falmouth and Kew—this source of uncertainty may usually be largely eliminated, provided there are any rapid movements which are shown at all the stations. The curves from the different stations are sufficiently alike to render identification of corresponding points easy. The accuracy of one's identification of any one peak can be verified by reference to other peaks. Thus while one cannot decide what the error actually is in the times shown on the curves of any one of the stations, one can usually determine approximately the difference between the errors at the different stations, and so make sure that the comparisons made refer to one and the same absolute time within a minute or so.

When we have rounded curves like that on p. 247 representing a slowly varying disturbance, a mistake even of several minutes is unlikely to make much difference in one's estimate of a disturbance, provided

one selects a time when the phenomenon is near its maximum. This consideration most likely influenced BIRKELAND'S choice of disturbances. If a bay or bays such as those on p. 247 occurs in the curves of one European station, it usually occurs simultaneously at other European stations, and in the cases selected by BIRKELAND this was true not merely of the European stations, but also to a greater or less extent of the other non-polar stations. Thus when the bay answered to a deep depression on the Arctic curves—and not infrequently trace was lacking from one or more of the Arctic stations, so that only two or three had to be considered—uncertainties of time may have been without any very serious influence on BIRKELAND'S conclusions. Another circumstance favourable to his measurements was that all relate to what was Winter at nearly all his stations, while a large majority relate to what were night hours at the Arctic and European stations. His 21 plates deal with a total of 207 hours, and of these 104, or one half, fall between 6 p.m. and 2 a.m., G.M.T. Uncertainties from the diurnal inequality were thus much reduced. When, however, one turns to the Antarctic curves which correspond to BIRKELAND'S, one is met by the converse of all this. The season is the Antarctic Summer, when changes, regular and irregular, are largest. The time in a large majority of cases falls in the Antarctic morning, often during the hours when, as already explained, oscillatory movements were especially numerous and rapid. A mistake of a few minutes in the time may make a huge difference to the result, and the curves are so unlike those at any of BIRKELAND'S stations that no help is usually forthcoming from the identification of peaks. If Arctic records exist synchronous with the occurrences of the "special type of disturbance" dealt with in Chapter X—which took place in the Antarctic Winter—anyone who attempts to apply BIRKELAND'S method to them will appreciate my difficulties.

After carefully comparing the Antarctic curves with BIRKELAND'S plates—in which the time-scale of the originals is usually much reduced—I decided that the application of BIRKELAND'S method was absolutely impossible in a number of cases, and that, in general, the uncertainties attending it were too great to justify the labour necessary. It will, however, I think, be found that the comparison which it proved possible to make has led to results of no small interest.

§5. Professor BIRKELAND believes that he has succeeded in recognising several distinct types of disturbance, to which he attaches specific names. The following table gives particulars as to the date and duration of the disturbed periods dealt with in his 21 plates. It also gives the total range in D and H at Kew during the time covered by each plate. Hours are counted from 1 to 24—0 or 24 signifying Greenwich midnight—that being the plan adopted by BIRKELAND. An entry such as October 11–12, hours 12–2, means that the time extended from 12 (*i.e.* noon) on October 11 to 2 a.m. on October 12. The range recorded for Kew represents the difference between the highest and lowest values of the element during the hours covered by BIRKELAND'S plate. It generally owes a good deal to the regular diurnal variation natural to the period of the day, except in cases where only night hours are included.

BIRKELAND'S Plate No.	Date.	Hours included, G.M.T.	Type of disturbance after BIRKELAND.	Range at Kew during interval.	
				D.	H.
	1902				
I	October 6 . . . . .	13½-15½	Cyclo-median	6.5	7
II	" 11-12 . . . . .	12-2	Compound	16.2	70
III	" 23-24 . . . . .	17-5	Equatorial	4.4	24
IV	" 27-28 . . . . .	14-1	Compound	8.6	45
V	" 28-29 . . . . .	14-1	"	6.9	31
VI	" 29-30 . . . . .	16-4	"	4.8	34
VII	" 31 to November 1 . . . . .	6-2	"	18.2	98
VIII	November 23-24 . . . . .	15-7	"	14.5	57
IX	December 9 . . . . .	5-18	Equatorial	4.4	35
X	" 14-15 . . . . .	23-5	Elementary polar	3.6	17
XI	" 24-25 . . . . .	23-5	Compound	3.8	8
XII	" 26-27 . . . . .	18-2	Elementary polar	5.2	25
XIII	" 28 . . . . .	3-8	Compound	2.0	10
	1903				
XIV	January 26 . . . . .	7-15	Equatorial	4.7	28
XV	" 26-27 . . . . .	18-7	Compound	19.3	49
XVI	February 8 . . . . .	8-12	"	8.3	43
XVII	" 8 . . . . .	13-24	"	18.8	55
XVIII	" 10-11 . . . . .	20-3	Elementary polar	6.5	41
XIX	" 15 . . . . .	13-20	Compound	11.2	25
XX	March 22-23 . . . . .	12-1	Elementary polar	14.7	39
XXI	" 30-31 . . . . .	19-3	" "	11.7	26

§6. The principal object in mentioning the ranges at Kew is to bring out an important point which I hardly think BIRKELAND himself quite realised, and which I am confident will not be realised by readers of his volume who are not themselves experts in Terrestrial Magnetism.

The mean value of the absolute daily range in D at Kew derived from all days of the eleven years 1890 to 1900 was 13'.57. This value, it will be observed, was exceeded on only six occasions in the table. During the eleven years the absolute daily range at Kew exceeded 20'—a value not once attained during BIRKELAND'S disturbances—on no less than 12 per cent. of the total number of days.

It must not, of course, be forgotten that the average length of the period covered by one of BIRKELAND'S plates is slightly under 10 hours, and that the majority of the periods do not include the hours at which the daily maximum and minimum most frequently occur. Still, taking everything into account, the fact remains that the great majority of the days selected by BIRKELAND were not what are ordinarily called *disturbed days*. In the Arctic, it is true, there were movements which would rank at Kew or any other non-polar station as magnetic storms, but there is not a single one of the occasions on which the phenomena at Kew would ordinarily be dignified with that name. On perhaps three occasions, October 31, to November 1, 1902, November 23-24, 1902, and February 8, 1903, one would have little hesitation in describing the *day* as disturbed, but on the other hand there is quite a considerable proportion of the days which one would be likely to describe as *quiet*. It is not merely that the movements on BIRKELAND'S selected days were small, but that they were few in number, and in many cases represented slow changes. In the case of an ordinary magnetic storm at Kew, not only would the range be much larger than in any of the days selected by BIRKELAND—a range of 30' in D and 300γ in H represents what may be called a *second class* storm—but the large movements would be much more numerous and some of them much more rapid. If we take a really first-class storm, like that recorded at Kew on October 31, 1903, it represents an altogether different order of conditions. Not merely is the range five or six times larger in D, more in H, but there are dozens of rapid oscillations, altogether without parallel in the most disturbed cases selected by BIRKELAND. The expenditure of energy during a first-class storm may, for all we know to the contrary, be 10, 100, or even 1000 times greater than that during BIRKELAND'S most disturbed day, and we cannot even say with certainty that the ultimate source of the energy, or the way in which it is expended, is the same in the two cases. What I have called a first-class storm is apparently experienced as a large storm over all the world—or at least over a very large part of it—and is invariably, or almost invariably,

accompanied by aurora visible even in the south of England, whereas the disturbances treated by BIRKELAND attained the development of a first- or a second-class storm if anywhere only in a portion of the polar regions. In the stations in temperate latitudes they were mostly of the size one meets with every other day, and if there were any auroral discharge accompanying them, it was not visible outside the region where auroral frequency is high.

§7. Returning to the table particularising BIRKELAND'S plates, we have now to consider the significance attached to the descriptive terms applied to the disturbances.

Explaining the term "equatorial," on p. 62, BIRKELAND says:

"... it is not unusual to find perturbations that are best developed and most powerful at the Equator. It has even been found that these perturbations in the regions about the Equator act principally upon the horizontal intensity... Such perturbations we... call equatorial... Of these there are... two kinds... , such as produce an increase in the horizontal intensity, and such as produce a diminution... The first... we have called *positive*... , the second... *negative equatorial perturbations*."

Of *polar elementary storms* BIRKELAND says, pp. 84-85:

- (1) "They are comparatively strong at the poles (meaning the north polar regions). The simultaneously perturbing forces, even as far north as the 60th parallel, have already sunk to about a tenth of their strength in the auroral zone.
- (2) "They are of short duration, frequently lasting not more than 2 or 3 hours.
- (3) "The conditions before and after are comparatively quiet.
- (4) "The oscillations at the (north) polar stations, especially the more southern ones, run a simple course. At the poles, they are often characterised by a simple increase to a maximum, and decrease to zero. We may sometimes, even at the northern stations, have to some extent an undulating form, answering to a slow turning of the perturbing force."

Of *compound perturbations* no general definition seems to be given. Judging by individual cases they are a combination of phenomena, "equatorial perturbations" predominating at one stage, and "polar elementary storms" at another.

BIRKELAND'S discussion of "*cyclo-median*" storms on p. 144 is somewhat lacking in clearness. After expressing his belief that "electric cyclones, wandering over the Earth's surface," according to a suggestion of Dr. AD. SCHMIDT, are a very rare phenomenon at least in large storms, he adds: "It appears, however, that there is a class of perturbations that are due to current-systems which appear in lower latitudes at a height above the Earth that is small in proportion to the Earth's dimensions... In the whole of our material, we have not found more than one considerable perturbation that in its entirety must be due to systems that come near to the Earth in lower latitudes."

It is this single occurrence (October 6, 1902) that is characterised as "*cyclo-median*." Judging by a remark on p. 150, the term was intended to signify that the disturbance was "as great in medium as in high latitudes," and that the electrical currents to which it was due were "vortical in form."

§8. It is difficult to discriminate between Prof. BIRKELAND'S observations and his theories, as the two are so interwoven in his pages. Thus some reference to his theoretical views may tend to clearness. He believes that the "equatorial" perturbations are due to electric currents encircling the Earth near the plane of the magnetic Equator, at a distance above the Earth which is similar to, possibly greater than, the Earth's radius. A current thus situated in a plane perpendicular to the Earth's magnetic axis would naturally give a force which in the equatorial regions would be roughly in the magnetic Meridian—thus affecting H almost exclusively—and the intensity would be greater in the Equator. Unless the height of the current were large, the disturbance would fall off rapidly as we departed from the Equator, and in even low latitudes there would be a large vertical component.

There does not seem to be in the volume any close comparison of the amplitude of the "equatorial" perturbations experienced on the same occasion at different stations; but the numerical data as to the disturbances during individual equatorial perturbations do not show such predominance in the equatorial regions as the definition leads one to expect.

So far as I can judge, a considerable number of the movements discussed in our Chapter IX, including

the "sudden commencements," would be classified by BIRKELAND as "equatorial" perturbations. In their case, however, as will be remembered, the amplitude at Colaba and Mauritius was usually less than that at Kew, and much less than in the synchronous movements seen in the Antarctic.

BIRKELAND believes an "elementary polar"\* storm to be due to what he calls "precipitation" in a comparatively limited Arctic area. By this he apparently means an influx (and efflux) of charged ions. In some calculations in the volume this is treated as equivalent to an electric current, approaching and receding from the Earth in lines which, if produced, would intersect at the Earth's centre. The current is regarded as stopping short of the Earth, then travelling in a straight line to a point equidistant from the surface, and finally receding. In some special cases on p. 103—which seem to be supposed to represent probable actual conditions—the height of the connecting (so-called "horizontal") portion is put at 200 or 300 kms., its length being taken as 1600 kms. and upwards. In the case of the "elementary polar" storms the disturbance at any given instant is large over only a very limited polar area. In temperate latitudes the disturbance is small and diminishes rapidly as the distance from the area of "precipitation" increases. This area usually keeps shifting its position, so that the disturbance travels across the polar regions.

If Prof. BIRKELAND had seen what has been called in Chapter X the "special type of disturbance" he would not unlikely have called it a south polar elementary storm. It seems, however, to present a much greater definiteness of type than BIRKELAND'S "polar" storms, and its duration is usually much less than the two or three hours which BIRKELAND speaks of.

§9. In his volume BIRKELAND does not take the *disturbances* in chronological order when discussing them, but treats first the "equatorial," secondly the "elementary polar," thirdly the "cyclo-median," and finally the "compound." One finds, however, that there are few of the occasions on which BIRKELAND failed to detect at one stage or another the presence of both "polar" and "equatorial" disturbances. I have thus thought it simplest to follow the chronological order, as BIRKELAND himself has done in the case of the 21 plates at the end of his volume. In what follows, the references are to BIRKELAND'S plates unless the contrary is explicitly stated, and the reader is strongly advised to have these plates before him while consulting the details given here.

§10. October 6, 1902 (hours 13½–15½, Plate I).

Of this "cyclo-median" disturbance, BIRKELAND, p. 150, says: "Its chief characteristics are that it is as great in medium as in high latitudes," also "the effect over the district Wilhelmshaven, San Fernando, Stonyhurst, Pola is of about the same magnitude." The difference from the "equatorial" disturbances, which otherwise it closely resembles, is that there appears hardly any movement in Asia or the Tropics. BIRKELAND infers that it must be due to electrical currents at a height "small in proportion to the Earth's dimensions."

The phenomenon, as presented at Kew and the other stations where it was best developed, had for its most prominent feature a sudden change in D, commencing at about 14h. 14m. At Kew, in the course of 5 or 6 minutes, the Declination needle moved about 4'·5 to the west and then returned much more slowly towards its normal position, taking nearly 30 minutes to reach it. H fell as D increased, but the total fall was only about 6γ; the return to the normal position was slow as in the case of D. The curves were exceedingly quiet for some hours before and after this movement. While the amplitude of the movement was very trifling, the isolation of the D movement and its nature are certainly unusual.

Whether there was or was not a corresponding movement in the Antarctic is open to doubt. In the Antarctic, as elsewhere, the day as a whole was exceptionally quiet; but, as was invariably the case in the Antarctic, both the D and the H curves show numerous small oscillations. The V curve was certainly not more disturbed between 14h. 10m. and 14h. 50m. than it was earlier in the day, and decidedly less disturbed than it was a few hours later. The same appears true of the D curve. There was, however—it may be a merely chance coincidence—a distinct bay on the H curve, whose inception was at least very nearly simultaneous with the commencement of the disturbance in Europe. Between 14h. 10m. and 14h. 21m. H fell 9γ, two-thirds of the fall taking place between 14h. 13m. and 14h. 18m. H remained below its previous value until 15h. 23m., the return movement being much the slower.

\* The terms "polar elementary" and "elementary polar" are applied indifferently.

This case is a good example of the uncertainties attending the application of BIRKELAND'S method to the Antarctic curves, even under the most favourable conditions. From inspection of the adjacent portions of trace one would conclude that D and V were normal, but H distinctly below the normal value from 14h. 13m. to 15h. 0m. If, however, we compare the values of the elements at 14h. 53m. (otherwise 2 a.m., L.T., on October 7) with the means for the same hour from the four nearest days, this is what we find:—

	D.	H.	V.
October 7 (2 a.m., L.T.) . . .	153 3·6	·06743	·7258
Adjacent days (2 a.m., L.T.) . . .	152 54·9	·06739	·7261

These figures point to exactly the opposite conclusion to that suggested by the form of the curves themselves.

§11. October 11–12, 1902 (hours 12–2, Plate II).

This "compound" perturbation is regarded by BIRKELAND, p. 251, as divisible into three so-called "sections," (i) from 11h. to 17h. 20m., and (ii) from 17h. 20m. to 18h. 30m. on October 11, (iii) from the last-mentioned hour to 0h. 30m. on the 12th.

The disturbance in section (i) is regarded as "mainly a positive equatorial perturbation," accompanied, however, from 12h. 25m. to 13h. 15m. by a "considerable polar perturbation." "The farther we go," BIRKELAND says, p. 252, "from the (N.) polar regions, the less perceptible does this brief polar perturbation become . . . . At Zi-ka-wei and Dehra Dun it is distinctly noticed, at Batavia it is almost imperceptible. At Christchurch, on the other hand, there is a rather violent perturbation . . . . (which) cannot have been produced by the same system . . . . for the effect of the latter is imperceptible (?) even at Honolulu and Batavia. The explanation of this seems to be that simultaneously with the descent (of ions or corpuscles) in the north, a similar phenomenon appears near the South Pole, and it is the effects of the latter that we observe at Christchurch."

This quotation has been given at length because it constitutes one of the very few references which I have observed to the possible existence of disturbance centres near the S-pole. The "explanation" was presumably purely a hypothesis on BIRKELAND'S part, as he had no records from south of Christchurch.

Section (ii), 17h. 20m. to 18h. 30m., was characterised by "violent storms in the Arctic," especially at Matotchkin Schar, but "the effect of the equatorial storm is still perceptible."

Section (iii), 18h. 30m. to 0h. 30m., "is characterised by a long polar storm," in the course of which, however, there appeared three short "intermediate" polar storms, the first with maximum about 18h. 34m., the second lasting from 20h. 45m. to 21h. 20m., the third from 23h. 10m. to 0h. 25m.

At Kew and all the other non-polar stations whose curves appear in Plate II there was a fairly sudden commencing movement, which does not seem to be mentioned by BIRKELAND. The H movement at Kew commenced about 12h. 18m., a fall of  $2\gamma$  and a rise of  $10\gamma$  occurring in about 6 minutes. A peak, representing a movement of about  $1'$  to the west, appeared also in the Kew D curve at about 12h. 24m., *i.e.* simultaneously with the maximum in H. Plate II shows this commencing movement *distinctly* at Colaba, Batavia, and Christchurch. It forms in fact the commencement of the movement at Christchurch, which BIRKELAND suggests may be due to currents near the S-pole.

At Kew and the other non-polar stations the disturbance consists mainly of bays in the H and D curves, with two or three small but fairly sharp peaks, the greatest departures from the normal appearing between 17h. and 22h. Christchurch differs a little from the other non-polar stations in that there is a bay on the H curve between 12h. 18m. and 14h. 10m., which commences less suddenly, but is larger than those encountered elsewhere; the later movements at Christchurch, on the other hand, are exceptionally small. The division into three sections seems somewhat arbitrary, especially the line of demarcation drawn at 18h. 30m. between Sections (ii) and (iii). This comes in the middle of a very rapid rise



in H at Matotchkin Schar, which according to Plate II extended from about 18h. 10m. to 18h. 35m., and which was *immediately* followed by a movement in the opposite direction, of so closely similar a character as to suggest its being an essential part of the same phenomenon. The significance of this will appear presently.

The Antarctic curves were fairly quiet, according to the Antarctic standard, until about 17h., but the H curve shows a prominent bay from about 12h. 13m. to 13h. 57m., the element being depressed and the minimum coming at about 13h. 18m. The fall and rise were each about 60 $\gamma$ .

During part of the time covered by the H bay there was also a bay on the D curve, a rise of 58' being followed by a fall of 45', and the maximum coming at about 12h. 53m.

As I' in D represents a force of about 1.9 $\gamma$ , the D movement was really the larger as well as the more rapid, but owing to the high sensitiveness of the H magnetograph the H movement appeals more to the eye. During the occurrence of the bays on the D and H curves the V trace shows numerous small oscillations of an irregular character, bearing no obvious relationship to the D and H changes, and not so suggestive of the "special type of disturbance" as the H trace is.

These D and H movements are synchronous with the "polar" storm of Section (i). Also, whilst there is no conspicuously rapid initial movement, the time of commencement is at least very approximately the same as that of the small sudden movement seen at Kew and elsewhere.

After 17h. the Antarctic curves certainly deserve to be called disturbed. The H trace showed the following changes, superposed on which were the usual short-period smaller oscillations:—

17h. 11m. to 17h. 16m.	fall 28 $\gamma$ ,
17h. 16m. ,, 17h. 20m.	rise 23 $\gamma$ ,
17h. 20m. ,, 17h. 31m.	fall 40 $\gamma$ ,
17h. 31m. ,, 17h. 42m.	rise 45 $\gamma$ ,
17h. 42m. ,, 17h. 53m.	fall 41 $\gamma$ .

D showed a number of small oscillations, but none conspicuously large; it increased, however, 90' between 16h. 53m. and 18h. 3m., going off the sheet at 18h. 3m. for a few minutes. During this time V rose and fell only about 10 $\gamma$ , though there were numerous small oscillations. The above movements seem to be associated. They are synchronous with the earlier part of BIRKELAND'S Section (ii), but also with the end of his Section (i). They are followed by a larger H movement.

Commencing to rise at about 18h. 21m., H, after increasing 74 $\gamma$ , got off the sheet at 18h. 27m. Re-appearing at 18h. 31m., in the next 29 minutes it fell 108 $\gamma$ , going beyond the limit of registration on the negative side. D commenced to fall at 18h. 21m., when H began to rise, and in the course of 26 minutes fell 61' and rose 70'. During this time V oscillations, though numerous, were small. The form of the Antarctic curves suggests that the phenomena from 18h. 21m. to 19h. 0m. were associated together, and the most natural inference seems to be that they form part of the disturbance which BIRKELAND regards as the first "intermediate" storm of his Section (iii). This was the time, it may be added, of one of the most prominent movements seen at BIRKELAND'S co-operating stations.

The next movements in the Antarctic worth mentioning were fairly synchronous with BIRKELAND'S second "intermediate" storm (20h. 45m. to 21h. 20m.) They are somewhat imperfectly shown, owing to lack of trace. Between 20h. 40m. and 21h. 3m. H fell 45 $\gamma$  and rose 50 $\gamma$  (possibly more, as the trace is very faint and part may be invisible). The D trace, which had gradually got off the sheet on the positive side, suddenly re-appeared at 20h. 51m. and fell 58' in 6 minutes. After a minor oscillation it began to rise rapidly at 21h. 6m., rising 55' before it again went off the sheet at 21h. 15m. During this time there were some very rapid movements in V; the total range between 20h. 46m. and 21h. 3m. was 22 $\gamma$ .

There was no Antarctic trace from 23h. 20m. to 23h. 45m. on the 11th. Between 23h. 48m. and 0h. 31m. on the 12th a bay appeared in the V trace, the maximum depression being about 12 $\gamma$ . There is a synchronous bay in the D curve, a fall of 43' being followed by a rise of 33'. The H trace was off the sheet practically all the time. The above D and V movements occur simultaneously with BIRKELAND'S third "intermediate" storm. They are by no means of an outstanding character and do not appeal much to the eye. They are followed, however, by a relatively quiet time.

§12. October 23-24, 1902 (hours 17-5, Plate III).

This is described, p. 76, as "a positive equatorial perturbation. It commences suddenly at 19h. 11m., simultaneously all over the Earth." It is added, however, "About  $1\frac{1}{2}$  hours later, a polar storm . . . characteristic, simple, and well defined, appears around the Norwegian (*i.e.* Arctic) stations . . . especially distinct at Matotchkin Schar." The date was not in BIRKELAND'S list, so he obtained curves from only a few stations, including, however, Bombay and Dehra Dun.

The sudden commencement is shown clearly at all the stations, including the Arctic ones. At Toronto, and at Axelöen in the D curve, the commencing movement appears distinctly double, the principal movement being preceded by a smaller movement in the opposite direction. At Kew there is only a suggestion of an initial fall in H, but nothing certain prior to a sudden rise, amounting to  $17\gamma$  in the course of 3 or 4 minutes. After the summit was reached at 19h. 14m., there was a gradual return to an undisturbed value at about 19h. 35m. Simultaneously with the change in H there was a very small change in D, westerly Declination rising and falling about  $0\cdot7$ .

In the Antarctic the curves had been unusually quiet for some hours when there suddenly began, at 19h. 10m., an exceedingly rapid rise in H. The movement is too rapid to be distinctly shown, but the trace seems to have gone off the sheet, remained off for 2 minutes, and returned to near its original position in 5 or 6 minutes. How much the oscillation exceeded that shown,  $+40\gamma$ , then  $-35\gamma$ , it is of course impossible to say. After slackening for a minute or two about 19h. 16m., H continued moving in the same direction as before, to a peak at about 19h. 22m. The fall in H since the curve came on the sheet was  $77\gamma$ . Simultaneously with the commencing movement in H there was an oscillation in D, a fall and rise each of  $15'$  taking place in about 4 minutes; this was followed by a second smaller oscillation.

The V trace, which had been exceedingly quiet, showed also a marked commencing movement, consisting of a rise of  $6\gamma$  in 3 or 4 minutes to a sharp peak at about 19h. 14m., followed by a fall of  $26\gamma$ , occupying about 8 minutes. Halfway during the fall there was a nearly stationary position during about 2 minutes.

The natural conclusion unquestionably is that these large sudden movements in the Antarctic correspond to the smaller commencing movements which appeared simultaneously elsewhere.

The principal disturbance in the Arctic occurs between 21h. and 23h., the maximum coming about 22h. 20m., but the Axelöen curves appear considerably disturbed until 3 a.m. on the 24th. The non-polar curves in Plate III show only very trifling disturbances, the largest, between 21h. and 23h. on the 23rd, being only of the same order as the sudden commencement at 19h. 11m.

In the Antarctic the conditions remained highly disturbed from 19h. 10m. until the traces got on the clamp at about 23h. 6m. The D and H traces show incessant large oscillations. The largest movements recorded in H were a rise of  $84\gamma$  between 19h. 56m. and 20h. 13m., and a rise and fall each of  $67\gamma$  between 22h. 51m. and 23h. 0m. The curve came on the sheet at 22h. 51m. and went off 9 minutes later. Coming on again immediately, H rose  $44\gamma$  in a few minutes, the trace coming on to the clamp and so being lost.

In D there was a rise of  $94'$  between 22h. 18m. and 22h. 25m., followed by a fall of  $100'$  during the next 10 minutes. Between 22h. 51m. and 23h., synchronous with the large changes in H, there was a fall of  $54'$  and a rise of  $87'$ , the latter immediately followed by a rapid fall of  $135'$ , the trace coming on to the clamp before the movement was completed.

Amongst the larger V movements were a fall of  $26\gamma$  and a rise of  $22\gamma$  between 19h. 54m. and 20h. 26m., a fall of  $20\gamma$  between 22h. 26m. and 22h. 33m., and a rise of  $51\gamma$  between 22h. 33m. and 22h. 53m. Between 22h. 53m. and 23h. 6m., when the trace got on the clamp, V fell  $24\gamma$ , rose  $37\gamma$ , and fell  $27\gamma$ .

The larger D and V movements, it will be noticed, occurred during the time when the Arctic stations were most disturbed; but the disturbance in the Antarctic was continuously large between 19h. 10m. and 23h.

The conditions in the Antarctic had become distinctly quieter by 0h. 11m. on the 24th, when the next sheet was put on, but might fairly be described as disturbed until 3h. 30m.

There was a small bay from 0h. 17m. to 0h. 53m., the changes in the three elements being at least approximately simultaneous. D rose  $25'$  and fell  $51'$ , just going off the sheet on the positive side; while V rose  $16\gamma$  and fell  $13\gamma$ . The H trace was off the sheet on the positive side for 10 minutes and the rise,

21 $\gamma$ , and fall, 14 $\gamma$ , actually shown were probably a good deal exceeded. After 0h. 53m. the oscillatory movements in the V curve were much reduced. The D trace, however, showed two moderate bays. During the first—from 0h. 53m. to 1h. 16m.—D rose 33' and fell 69'. During the second—from 1h. 16m. to 3h. 23m.—D rose 42' and fell 70'. Between 1h. 39m. and 2h. 17m. H fell and rose 39 $\gamma$ . The trace went off the sheet at 2h. 17m. and did not reappear until 3h. 27m. It went off and came on steeply, so there may have been a considerable movement in the interval.

§13. October 27–28, 1902 (hours 14–1, Plate IV).

This "compound" disturbance is divided by BIRKELAND, p. 209, into two sections. The first section, from 14h. to 20h. 30m., is regarded as composed of a long storm, largest on the whole in the Equator, during which there is an "intermediate" storm, most powerful in the Arctic, especially at Axelöen and Matotchkin Schar, which lasted from about 15h. 30m. to 16h. 45m.

At Kew, which was fairly representative of non-Arctic Europe, the most prominent phenomenon of Section (i) was a bay in the D curve from about 15h. 30m. to 16h. 55m., the element being depressed. The greatest departure from the normal value was about 7' and occurred about 16h. 20m. The corresponding H movement was a fall of 22 $\gamma$  from 15h. 15m. to 16h. 5m., interrupted by two small recoveries, and a rise of 19 $\gamma$  from 16h. 5m. to 16h. 30m., followed by a smaller fall.

BIRKELAND'S Section (ii), from 21h. 40m. to about midnight, consisted of a "polar" storm, largest at Axelöen. A table on p. 212 gives particulars of its beginning and end and also as to the time of occurrence and the value  $P_1$  of the largest disturbance in the horizontal plane. The commencement is about 21h. 40m. and the hour of maximum about 22h. 50m. at most stations; the end varies from 23h. 20m. on the 27th to 0h. 20m. on the 28th.  $P_1$  varies from 265 $\gamma$  at Axelöen to 4 $\gamma$  at Dehra Dun, the value at Kew, 29 $\gamma$ , being slightly above the average for non-Arctic European stations.

The general nature of the disturbance during Section (ii) outside the Arctic is fairly represented by the phenomena observed at Kew. D there was distinctly depressed from 21h. 40m. on the 27th until about 0h. 10m. on the 28th. The most rapid change was a fall of 3' between 22h. 20m. and 22h. 45m. H, on the other hand, was distinctly above the normal value from 21h. 40m. to 23h. 20m. The maximum occurred about 22h. 54m., and the most rapid change was a fall of 20 $\gamma$  between that hour and 23h. 34m.

The Antarctic curves during the time covered by Plate IV show a moderate amount of disturbance, but nothing, perhaps, that would naturally attract attention. During the "intermediate" storm of BIRKELAND'S Section (i) there was a bay on the D curve between 15h. 29m. and 16h. 53m., the element rising 47' and falling 33'. The V trace showed numerous oscillations, but the largest only 3 $\gamma$  or 4 $\gamma$  in amplitude. The H trace was beyond the limit of registration in the negative direction from 15h. 43m. to 16h. 53m., and may of course have been considerably disturbed.

The largest movements recorded during Section (i) took place later, between 18h. 53m. and 19h. 53m. During this hour D rose and fell 66', H rose 99 $\gamma$ , while V fell 14 $\gamma$  and rose 35 $\gamma$ .

The D trace was off the sheet on the positive side for some time after 21h. and there was no trace from 22h. 16m. to 22h. 36m. There is thus rather a lack of information as to what was happening during BIRKELAND'S Section (ii). After 22h. 36m., when registration was resumed, there was no really striking D movement. There was, however, a small bay between 23h. 16m. and 23h. 56m., the value rising 18' and falling 30'. The H trace, which had just got off the sheet on the positive side at 22h. 46m., came on again at 22h. 47m., and between that hour and 23h. 33m. H fell 53 $\gamma$ . After 23h. 33m. H rose gradually with minor oscillations until 0h. 53m. on the 28th, when the trace again went off the sheet on the positive side and remained off for two hours.

V fell 32 $\gamma$  between 22h. 36m. and 23h. 17m., and rose 40 $\gamma$  between 23h. 17m. and 23h. 43m. After a slight halt it continued to rise, but much more slowly, until 0h. 17m. on the 28th. Between 0h. 17m. and 0h. 45m. it fell 19 $\gamma$ . Thereafter the V trace was relatively quiet for some hours.

§14. October 28–29, 1902 (hours 14–1, Plate V).

This was another "compound" storm, which resembled that of the previous day in containing two "intermediate" elementary polar storms. The interval between these was, however, much less than on the previous day, and there was, according to BIRKELAND, p. 222, in lower latitudes, "no trace on the 28th of the long storm that occurred on the 27th, and was especially powerful at the Equator." According to BIRKELAND'S

table, p. 222, the first "intermediate" storm commenced about 18h. 10m. and ended about 19h. 30m. at most European stations, the maximum coming about 18h. 45m. The value of  $P_1$ —the maximum horizontal disturbing force—varied from  $248\gamma$  at Axelöen to  $3\gamma$  at Toronto, the value at Kew,  $16\gamma$ , being slightly under the average for non-polar European stations.

The time of commencement of the second "intermediate" storm is given as about 21h. 30m. at most stations, but somewhat earlier in the Arctic. The end is given as usually somewhat after 23h. The maximum is said to have occurred about 22h. 10m., the value of  $P_1$  varying from  $266\gamma$  at Axelöen to  $2\cdot5\gamma$  at Batavia. The value given for Kew,  $16\cdot5\gamma$ , is again slightly below the mean for non-Arctic Europe.

The disturbances outside the Arctic were really very trifling. The most notable change at Kew was a rise of  $20\gamma$  in H between 21h. 30m. and 21h. 48m.

In the Antarctic there was no loss of V-trace during the time covered by Plate V, except from 22h. 43m. to 23h. 13m., when there was no sheet on the drum, and the H trace was off the sheet only for a short time before the end. The D trace, however, was off the sheet a good deal between 20h. and 22h. 43m.

The largest D movements recorded took place between 19h. 10m. and 19h. 58m., and so synchronise with or overlap the latter part of BIRKELAND'S first "intermediate" storm. During this time D rose  $41'$ , fell  $28'$ , rose  $45' +$  (going off the sheet), fell  $52' +$ , and rose  $50'$ .

Some rather notable oscillations also occurred in H. The element rose  $37\gamma$  and fell  $53\gamma$  between 18h. 38m. and 19h. 0m., the turning point (a maximum) being at 18h. 50m. and so practically simultaneous with the maximum in BIRKELAND'S first "intermediate" storm. Another considerable oscillation took place between 19h. 40m. and 20h. 10m., H first rising  $55\gamma$  and then falling  $52\gamma$ . The V trace showed numerous small oscillations. There was one rather sharp oscillation between 20h. 5m. and 20h. 16m., a fall of  $19\gamma$  being followed by a rise of  $18\gamma$ . The intervening minimum occurred at 20h. 9m. Between this hour and 21h. 20m. there was a total rise of  $36\gamma$  in V, which was followed during the next 20 minutes by a fall of  $27\gamma$ .

The D trace went off the sheet rather steeply at 21h. 45m., and came on rather steeply at 22h. 25m., so there may have been a considerable oscillation in this element during the time of BIRKELAND'S second "intermediate" storm. The H and V traces, however, after 21h. 40m. were quieter than they had been for some hours previously. Thus whilst there was decidedly more than the average amount of disturbance in the Antarctic during BIRKELAND'S first "intermediate" storm, it is at least doubtful whether the same was true of the second "intermediate" storm.

§15. October 29-30, 1902 (hours 16-4, Plate VI).

This "compound" perturbation is said, p. 161, to consist of an "equatorial" perturbation—which commenced suddenly on the 29th at 16h. 52m., and whose most active phase in the southern stations appeared at about 1h. 30m. on the 30th—and of "polar" storms. Whether BIRKELAND supposed the same equatorial perturbation to last continuously all the time is not clear. As to the nature of the coincidence of the equatorial and polar disturbances, p. 161 says: "The positive equatorial perturbations observed by us are *always* accompanied by polar storms. As a rule, the polar storms do not begin until a little while after the equatorial; but on this occasion they begin almost simultaneously. . . ."

In discussing his Chart I, which includes results for hours 18h. 52·5m. and 20h. 30m. on the 29th, BIRKELAND concludes, p. 164, that "it is the polar systems that give the field its character," and he puts the "centre" of the polar system near Matotchkin Schar. In discussing Chart II for 1h. 0m. on the 30th, he regards the field as "now mainly conditioned by the equatorial perturbation."

During the major part of the polar storm BIRKELAND had records from only two polar stations, Axelöen and Matotchkin Schar. The largest movements shown at either occur between 18h. and 21h.

At the non-polar stations there was a distinct sudden commencement—not clearly apparent at the polar stations—whose time of occurrence BIRKELAND puts at 16h. 52m. The original Kew H trace shows a small fall, about  $1\gamma$ , between 16h. 52m. and 16h. 54m., followed by a rise of about  $4\gamma$  during the next 4 minutes.

The most noteworthy movement at Kew and the other non-polar stations took place between 1 and

2 a.m. on the 30th, the maximum displacement being that already referred to as occurring about 1h. 30m. The disturbance at this hour appears to have been a good deal larger at Dehra Dun, Batavia, and Christchurch than at the non-polar European stations, BIRKELAND'S estimate of the horizontal disturbing force being  $43\gamma$  at Batavia and  $40\gamma$  at Christchurch, as against  $14\gamma$  at Kew.

In the Antarctic there was an outstandingly rapid rise of H from about 16h. 55m. to 16h. 59m., followed by an equally rapid and larger fall. The trace was very faint near the time of the turning-point, and got beyond the range of registration at 17h. 5m., so that all one can be sure of is that between 16h. 55m. and 17h. 5m. H rose at least  $27\gamma$ , and fell at least  $37\gamma$ . A slow rise in H commenced about 16h. 53m., but this was checked for a few seconds at 16h. 55m., and the movement did not attain its highest rapidity until perhaps 16h. 56m. This H movement occurred at a time when the trace had been rather quieter than usual for an hour or more, and there can be little doubt that it represents the sudden commencement seen at BIRKELAND'S non-polar stations. In the Antarctic, synchronous apparently with the commencing movement in H, there was a sharp oscillation in V, a rise of  $10\gamma$  and fall of  $6\gamma$  taking place in about 6 minutes. D, which had been rising on the whole fairly steadily with minor oscillations, began a more decisive though not conspicuously rapid rise about 16h. 56m. During the next 27 minutes it rose  $73'$  and the trace then got off the sheet. It came on the sheet 3 minutes later, but, after being on for about 18 minutes, got off once more, and thereafter was seen only at rare and short intervals during the remainder of the time covered by Plate VI.

The H trace remained beyond the limits of registration until about 19h. 18m., and was again lost sight of about 19h. 45m. The light in the Antarctic magnetographs evidently became very faint towards the end of the sheet, as even the base lines are but faintly indicated after 21h. The V trace, which suffered less from weak illumination than the D and H traces, had become invisible by this hour. It is thus possible that faintness of light may have been partly responsible for the non-appearance of the D and H traces after 20h.

The persistence, however, of active disturbances until the time when the V trace became invisible may be safely inferred from the following list of observed changes in V :—

From 17h. 6m.	to 17h. 48m.	rise $57\gamma$ ,
„ 17h. 48m.	„ 17h. 54m.	fall $36\gamma$ ,
„ 17h. 54m.	„ 18h. 5m.	rise $33\gamma$ ,
„ 18h. 57m.	„ 19h. 8m.	rise $38\gamma$ ,
„ 19h. 8m.	„ 19h. 30m.	fall $58\gamma$ ,
„ 19h. 30m.	„ 19h. 45m.	rise $33\gamma$ ,
„ 19h. 45m.	„ 20h. 1m.	fall $36\gamma$ ,
„ 20h. 1m.	„ 20h. 8m.	rise $30\gamma$ ,
„ 20h. 8m.	„ 20h. 23m.	fall $35\gamma$ .

The major part of these V disturbances synchronise with BIRKELAND'S "polar" storm, but some precede it. Shortly after the last movement recorded above the trace became invisible.

After the next sheet was put on at 23h. 20m., distinctly disturbed conditions existed until after 3 a.m. on the 30th. The changes in V were especially noteworthy. Between 0h. 0m. and 1h. 4m. on the 30th there was a rise of  $92\gamma$ , between 1h. 4m. and 1h. 46m. a fall of  $74\gamma$ , and between 1h. 46m. and 2h. 46m. a rise of  $93\gamma$ . H rose  $52\gamma$  between 0h. 0m. and 0h. 40m., the trace then going off the sheet on the positive side. After being off for 9 minutes it came on, but 20 minutes later it went off again on the positive side. Coming on once more at 1h. 36m., it showed a fall of  $59\gamma$  between 1h. 36m. and 2h. 17m., and a rise of  $59\gamma$  between 2h. 17m. and 2h. 35m. The trace went off the sheet at the latter hour, and except for a short appearance of about 10 minutes re-appeared no more until after 8h.

During the above changes in V and H the chief movements in D were a fall of  $129'$  between 1h. 10m. and 1h. 43m., and a rise—interrupted for 25 minutes by minor oscillations—of  $87'$  between 1h. 43m. and 2h. 45m. After 3h. 30m. the D and V traces were specially quiet during the next 5 hours. The H trace being off the sheet, one cannot be certain that it was equally quiet.

It will doubtless have been noticed that the largest movements recorded in the Antarctic occurred

during the time when BIRKELAND'S "polar" storm was largest, and during the time of his largest "equatorial" disturbance. There is, however, no sign of intermission in the disturbance, though the evidence is not complete owing to failure of the trace.

Later in the 30th, it may be added, after the time covered by Plate VI, there was a very prominent bay in the Antarctic D curve, extending from about 8h. 20m. to 9h. 33m. It included a fall of 142' and rise of 115'. This disturbance was at least an approach to the "special type," V oscillating about a mean position during the fall of D, and rising about 30γ during the rise of D. There was a synchronous bay on the H curve, but details are lacking, as the trace was off the sheet most of the time.

§16. October 31 to November 1, 1902 (hours 6-2, Plate VII).

Of this "compound" storm BIRKELAND says, p. 230, "It appears at the poles with tremendous violence, although perhaps its strength is even more unusual at the equatorial stations. Considering its long duration and its universal distribution, we may say that it is the greatest storm that has been observed by us." He regards the disturbance as consisting of a long storm lasting from about 9h. on the 31st to 3h. on Nov. 1, with two, if not more, "intermediate" storms.

Referring to his first eight charts, which answer to times from 9h. 0m. to 12h. 30m. on October 31, he says, p. 232, that the equatorial stations show "powerful perturbing forces directed southwards," the forces at Dehra Dun and Batavia being almost double those in central and southern Europe. During this time BIRKELAND'S Arctic stations showed no very large disturbances, but Sitka was highly disturbed.

Charts IX, X, and XI, for 13h. 30m., 13h. 42m., and 14h. 0m., represent the conditions during the "first powerful intermediate storm," whose maximum is put at 13h. 42m. This includes the time of largest movements at the polar and equatorial stations. There are also movements at all the non-polar European stations, but these are on the whole smaller than the movements later in the day.

After 14h. 0m. conditions were everywhere less disturbed for some hours. But from 17h. 45m. to 1h. 0m. on Nov. 1 there were further large disturbances in the Arctic and the European stations, which are dealt with in BIRKELAND'S Charts XII to XIX.

The second "intermediate" storm is regarded as extending from 23h. 12m. to 0h. 42m. on Nov. 1, with maximum about 23h. 45m., and after its conclusion the conditions became much quieter.

As usual, Kew seems to be fairly representative of non-polar European stations. It is very difficult there to assign even an approximate time for the commencement of the disturbance. One has to go back to 20h. on the 30th to get a time really free from the small undulatory movements which represent the disturbance up to noon on the 31st. The end of the disturbance between 3 and 4 a.m. on Nov. 1 is more definite. The Kew D curve shows two slow wave-like movements in immediate sequence, extending from 7h. 30m. to 10h. 0m. on the 31st, the rise and fall in each being from 1' to 2'. From 11h. 40m. to 14h. 30m. there was another group of movements of a more irregular character, which included a fall of 4' and rise of 3' between 13h. 20m. and 13h. 50m. This corresponds to BIRKELAND'S first "intermediate" storm.

From 17h. on the 31st to 2h. on Nov. 1 there was considerably more disturbance at Kew than earlier. Between 17h. 0m. and 17h. 48m. D fell and rose 3', reaching a sharp peak at the latter hour. After 17h. 48m. D continued to fall generally, with minor oscillations, until 22h. 10m., the fall in this time amounting to 13'. D then rose 4'·3 in two steps to a rounded peak at 23h. 10m. Between this hour and 0h. 45m. on Nov. 1 it fell 6' and rose 7'; the turning-point, which was the minimum during the disturbance, was at about 23h. 42m.

In the Kew H curve the most rapid changes were a fall of 26γ and rise of 23γ between 13h. 15m. and 13h. 42m.—corresponding to BIRKELAND'S first "intermediate" storm—and a fall of 25γ between 17h. 45m. and 17h. 53m. There was a comparatively quiet time from 14h. 40m. to 17h. 45m. After the latter hour there was no cessation of disturbance until about 2h. on Nov. 1.

In the Antarctic a highly disturbed state of matters existed from about 8h. 50m. to 14h. 0m. on the 31st. The phenomena resembled four disturbances of the "special type," following one after the other without any interlude; but D and V were not quite in phase, and most of the turning-points on the H trace were beyond the limits of registration, so one can only see that this element was *approximately* in phase with V.

We may regard the V movements during this time as composed of four "waves," whose times and amplitudes were as follows (+ denotes a rise, - a fall):—

Wave	From	To	Change (in $\gamma$ ).
1	h. m. P 8 51	h. m. 8 51 9 23	P + 26
	2	9 23 10 13	10 13 10 59
3		10 59 11 50	11 50 12 30
	4	12 30 13 33	13 33 14 1

Each "wave" except the third left V enhanced, so that the final value exceeded the original by 60 $\gamma$ . There were four "waves" in D roughly corresponding to those in V.

During the first D fell 75' and rose 72'.  
 " " second " " 102' " " 133'.  
 " " third " " 81' " " 195'.  
 " " fourth " " 173' " " 80'.

H fell 108 $\gamma$  between 9h. 32m. and 10h. 23m., rose 56 $\gamma$  between 10h. 23m. and 11h. 5m., and fell 57 $\gamma$  between 11h. 5m. and 11h. 30m. The trace went off the sheet on the negative side at 11h. 30m., remaining off until 12h. 46m. It came on again, but only for a few minutes, showing a double peak at 12h. 50m., and was thereafter no more seen until 20h. 53m.

The last of the four waves above mentioned in the Antarctic synchronises with BIRKELAND'S first "intermediate" polar storm. But it seems impossible to draw any line of demarcation, such as BIRKELAND draws, between it and what precedes. The four waves are of the same type and follow in immediate sequence, and it is difficult to believe that the first three can be due to "equatorial" perturbation if the last is due to "polar." The storm in the Antarctic probably existed for some hours before 8h. 51m., as the D trace contains two bays similar to, though smaller than, the four we have described. The H trace, however, was off the sheet after 1h. 20m., and the V magnetograph not working until nearly 8h. 51m., so our information is very limited before this hour.

After 14h. 1m. there was probably an absence of large rapid movements in the Antarctic until nearly 21h. The H trace was off the sheet, and the D trace also after 17h. 40m., but the V trace remained on until the sheet was taken off at 22h. 7m., and its course was unbroken by any oscillations at all comparable with the four we have described. There was, however, a persistent fall in V, as if the cumulative effect of the four waves were gradually disappearing. The total fall between 14h. 1m. and 20h. 41m. amounted to fully 70 $\gamma$ .

After 20h. 50m. there were some more wave-like movements in the V trace, though not so large as the earlier ones. The two principal consisted, the first of a fall of 21 $\gamma$  and rise of 12 $\gamma$  between 20h. 50m. and 21h. 28m., the second of a fall of 30 $\gamma$  and rise of 16 $\gamma$  between 21h. 28m. and 22h. 9m.

The H trace, after having been beyond the limits of registration on the negative side for nearly 8 hours, came on the sheet at 20h. 58m., and H rose 89 $\gamma$  between that hour and 21h. 30m. Rising further, with minor oscillations, it got off the sheet on the positive side at 22h. 2m., having risen 110 $\gamma$  since 20h. 58m.

There was no record from 22h. 7m. to 23h. 46m., which covers half the time of BIRKELAND'S second "intermediate" storm. When the next sheet was put on at 23h. 46m., the H trace was off the sheet on the positive side, and it remained off until 4h. 30m. on November 1. The D and V traces on the second sheet show, however, no signs of *special* disturbance. The largest movements in the V trace are two bays, the first, from 1h. 33m. to 2h. 45m., having a rise and fall of only 16 $\gamma$ , the second, from 2h. 45m. to 3h. 56m., showing a rise of 43 $\gamma$  and fall of 27 $\gamma$ .

§17. November 23-24, 1902 (hours 15-7, Plate VIII).

This "compound" storm, divided by BIRKELAND into three sections, is said, p. 272, to be the most powerful of a series which developed daily in the Arctic from the 19th to the 26th of November.

Section (i), from 15h. 20m. to about 16h. 0m., is described, p. 273, as a "typical positive equatorial storm," "strongest at the equatorial stations in the South of Asia." BIRKELAND speaks of a sudden rise occurring in H at 15h. 30m., except at the American stations, where the rise is slow. The time is not, I think, intended to be exact. For at Kew H begins to rise at about 15h. 22m., rising  $10\gamma$  to a rounded maximum at about 15h. 32m., and then diminishing about  $6\gamma$  during the next 7 minutes. There was a corresponding small movement in D, whose maximum was, however, a few minutes later. These trifling movements—which can, however, be recognised at Axelöen, Kaafjord, and all the European and Southern stations—constitute the largest disturbance of Section (i).

During Section (ii), from 16h. to about 22h., the disturbing forces are generally small, but from 17h. 30m. to 18h. 20m. the disturbance is somewhat greater, "especially in southern latitudes."

In the Arctic BIRKELAND sees indications of a "polar" storm of minor intensity. During this time the most noteworthy feature at the non-polar European stations is a bay on the D curve, extending from about 17h. 0m. to 18h. 30m. at Kew, where the element fell and rose about 3'. The most prominent H changes at Kew were a fall of  $12\gamma$  between 17h. 23m. and 17h. 35m., and a fall of  $11\gamma$  between 19h. 52m. and 20h. 3m.

BIRKELAND'S discussion of his Section (iii), 22h. to 7h., appears involved. He attempted apparently to recognise a series of "elementary polar" storms in it, but was unable to disentangle them. Speaking generally, the Arctic curves show numerous rapid oscillatory movements going on pretty continuously all the time.

At the non-polar stations the most disturbed time was from 22h. on the 23rd to 3h. on the 24th. The movements during this time were really of some size. At Kew, for instance, D fell 10' between 22h. 5m. and 22h. 42m., rose 5' between 0h. 30m. and 0h. 50m., fell  $6\cdot8$  between 0h. 50m. and 1h. 20m., rose  $10\cdot4$  between 1h. 20m. and 2h. 10m., fell 9' between 2h. 10m. and 2h. 43m., and rose 7' between 2h. 43m. and 3h. 12m. H fell  $37\gamma$  in three steps between 21h. 48m. and 23h. 1m., rose  $35\gamma$  in two steps between 23h. 1m. and 23h. 42m., fell  $29\gamma$  in two steps between 23h. 42m. on the 23rd and 1h. 35m. on the 24th, rose  $42\gamma$  between 2h. 2m. and 2h. 24m., and fell  $30\gamma$  between 2h. 48m. and 3h. 52m.

The conditions existing at the southern stations during the early morning of the 24th will be best realised by consulting the Christchurch H curve given in Plate XV of the present volume.

In the Antarctic there were some very rapid oscillatory movements synchronous with the commencing movements seen at Kew and elsewhere which BIRKELAND characterised as "equatorial." The D movements were so rapid that the turning-points are not very clearly shown, and the following measurements may be slightly under-estimates. Commencing suddenly, during a fairly quiet time, we have between 15h. 21m. and 15h. 37m. a rise of 81', a fall of 78', a second rise of 60' and a second fall of 85', with minor oscillations during the larger movements. There were presumably corresponding movements in H, as the curve which had been off the sheet for some time on the negative side came on for a couple of minutes about 15h. 24m., forming a very sharp peak (maximum). During the second oscillatory movement in D there was a marked depression and recovery in V, of amplitude  $44\gamma$ . After this commencement the Antarctic curves remained highly disturbed until 10h. on the 24th. They are reproduced from 0h. 18m. to 10h. 31m. (or 11.25 a.m. to 9.38 p.m., L.T.) in Plate XXV of the present volume. The most conspicuous movements prior to the time covered by this plate were as follows:—

D after falling 226', with numerous oscillations, between 15h. 28m. and 16h. 25m., rose again, oscillating vigorously, about 197' between 16h. 25m. and 18h. 8m., and then fell 127' between 18h. 8m. and 18h. 58m. A specially rapid movement about 19h. 19m. is referred to presently in conjunction with a corresponding H change. Between 19h. 19m. and 21h. 3m. D rose, oscillating largely, 208', and the trace went off the sheet on the positive side for a few minutes at the latter hour. After coming on the sheet, the D trace in the course of about half an hour fell 97', rose 72', fell 75', and rose 100', going off the sheet again about 21h. 40m. Its reappearance a few minutes later is not very clearly shown, and at 22h. 8m. it disappeared, to be seen no more before the sheet was removed at 23h. 13m.



The movements just recorded extend over BIRKELAND'S Sections (i) and (ii) and show no interlude.

Until 21h. the H trace was mostly off the sheet on the negative side, appearing at intervals for a few minutes at a time. The most striking movement seen during this time answered to a peak at about 19h. 19m. The trace was visible for about 8 minutes, during which H rose and fell 68 $\gamma$ . This happened synchronously with an exceedingly rapid oscillation in D, that element in the course of 11 minutes falling 97' and rising 88'.

Later the H trace was more in evidence. Between 20h. 53m. and 21h. 8m. H rose 66 $\gamma$  and fell 49 $\gamma$  with minor oscillations. Between 21h. 8m. and 21h. 20m. it rose 140 $\gamma$ , the trace then going off the sheet on the positive side and remaining off for 20 minutes.

On reappearing at 21h. 40m. the H trace fell 136 $\gamma$  in 7 minutes, then rose 54 $\gamma$  and fell 70 $\gamma$  in the course of the next 11 minutes, and went off the sheet on the negative side about 21h. 58m. It was not again seen, except for a few minutes, until about 22h. 37m., when it appeared and rose 103 $\gamma$  during the next 10 minutes.

There were numerous minor oscillations all this time in the V trace, the most striking being a fall of 65 $\gamma$  and rise of 50 $\gamma$  between 19h. 17m. and 19h. 28m., a time during which there were also rapid oscillations in D and H. But perhaps the most outstanding feature is the continuous downward tendency of the curve from 16h. 15m. to 21h. 40m., the total fall during this time being about 300 $\gamma$ . After some small oscillations V then commenced to rise rapidly, the rise between 21h. 57m. and 22h. 42m. representing 182 $\gamma$ .

From 23h. 13m. on the 23rd to 0h. 19m. on the 24th there was no paper on the drum, and though substantial alterations took place in the values of the elements during this interval it may have been quieter than the times before or after. But there is no direct evidence of any marked lull from the commencement, about 15h. 20m. on the 23rd, until 10h. on the 24th. No subdivision into sections nor difference in source is at all suggested by the Antarctic D and H curves.

The case of V is rather different, as that element, on the whole, rose between 15h. 35m. and 16h. 15m., and again between 21h. 40m. and 22h. 42m., while it fell during the intervening time.

In the Antarctic there can be no question that the disturbance of October 31 to November 1 was smaller than that of November 23-24. The range of the elements appears greater at Kew on the former occasion, but that is due to the fact that the period was longer and included the ordinary hours of the daily maximum and minimum. The appearance of the Kew curves would indicate that the later disturbance was the more intense, and this is really borne out by BIRKELAND'S figures on pp. 240 and 280 for the amplitude of the disturbing force.

§18. December 9, 1902 (hours 5-18, Plate IX).

This is entered amongst the "equatorial" storms. When discussing it on p. 70 BIRKELAND describes the disturbance as illustrating at its commencement "all the properties that characterise the positive equatorial perturbations. It commences quite suddenly, simultaneously all over the Earth, at 5h. 40.6m." This movement is seen in the Arctic as well as the non-polar regions. It is, however, by no means large at most stations. At Kew, for instance, the initial rise in H was only about 5 $\gamma$  and it was not very rapid. BIRKELAND regards "equatorial" conditions as persisting until nearly 15h. During this time there are no large movements even in the Arctic.

"Between 15h. and 18h., the character of the perturbation conditions is essentially changed. It is this feature that we continually find repeated, namely, that when the equatorial storm has lasted for some hours, polar systems appear." p. 70. During the time stated there was a disturbance of some size at all the Arctic stations, and even at the non-polar stations there were appreciable bays on both the H and D curves. Thus at Kew the H trace shows a bay from 16h. 25m. to 17h. 40m., the greatest depression representing about 15 $\gamma$ ; corresponding to this was a hump on the D curve, the maximum representing a rise of about 2'.5.

In the Antarctic there were of course numerous movements larger than any at Kew, but there is no very decided trace of disturbance until towards the end of the period covered by Plate IX. On this occasion it is very doubtful whether there is anything in the Antarctic curves corresponding to the sudden movement seen elsewhere about 5h. 41m. There is, it is true, apparently at this exact time a trifling but sharp peak in the V trace—which previously was very quiet—representing a very rapid rise and fall of

1 $\gamma$  or 2 $\gamma$ , and this is followed by a rise of about 7 $\gamma$  in the course of the next 6 or 7 minutes. There were peaks on the D curve at 5h. 41m. and 5h. 45m. Between these two times D rose 7', and during the next 9 minutes it fell 14'. There was also a peak on the H trace at about 5h. 41m., the next turning-point being about 5h. 51m.; in the interval H rose 20 $\gamma$ . These movements in the D and H curves are, however, not conspicuously different either in size or rapidity from a good many others, and the apparent coincidence in time may be accidental.

One would hardly describe the Antarctic curves as disturbed until after 16h. From then until 23h. the disturbance was continuous and very considerable. During the time covered by Plate IX the largest movements recorded in D were a fall of 156' between 16h. 44m. and 17h. 13m., followed by a rise of 213' between 17h. 13m. and 17h. 33m. The H trace was mostly off the sheet after 15h. V, however, showed some considerable movements, rising 79 $\gamma$  between 17h. 10m. and 17h. 35m., falling 62 $\gamma$  between 17h. 37m. and 17h. 46m., then rising 38 $\gamma$  between 17h. 46m. and 17h. 57m., and falling 80 $\gamma$  between 17h. 57m. and 18h. 17m. This last movement, however, extends beyond BIRKELAND'S period.

The Antarctic movements after 16h. 47m. are shown in the right-hand figure of our Plate XL. In it 4 a.m., December 10, answers to 16h. 53m., G.M.T., on the 9th. This figure shows the Antarctic disturbance for more than an hour subsequent to the time covered by BIRKELAND'S Plate IX. The movements which it shows, though large, are if anything inferior in size to some recorded between hours 20 and 22, G.M.T., *i.e.* about two hours later. The disturbed conditions continued until nearly 23h. One might thus be inclined to infer that the Antarctic storm, while so far synchronous with that observed in the Arctic and elsewhere after 16h., continued long after the disturbance elsewhere had ceased. The D and H Kew curves show, however, between 19h. and 22h., some movements which, though less than those between 16h. and 18h., are larger than those occurring between 5h. and 7h. It would be of interest to know what was happening in the Arctic between 18h. and 22h.

§19. December 14–15, 1902 (hours 23–5, Chart X).

This "elementary polar" storm is described by BIRKELAND, p. 87, as appearing "upon an otherwise very calm day . . . without any preceding equatorial perturbation," and as consisting of "a great storm in the north, about Dyrafjord and Axelöen . . . accompanied by a perturbation, small indeed, but well defined, . . . observed in Northern America and Europe."

The effect is described as "just perceptible" at Dehra Dun, but not visible at Batavia. At Dyrafjord, where the movement was largest, the storm is said to have lasted from 0h. 10m. to 3h. 15m., the maximum value of the disturbing force, 386 $\gamma$ , being met with about 1h. 8m. At Axelöen, where the maximum disturbing force was about half that at Dyrafjord, the times were somewhat later, the maximum not appearing until 1h. 46m. In temperate Europe the disturbance is said to begin "rather suddenly at 0h. 45m." and to last about 3 hours. BIRKELAND adds, "This perturbation . . . has its origin in the northern regions. Its sphere of action . . . is concentrated about the neighbourhood of Dyrafjord and Axelöen. The shortness of its duration, as also the comparatively calm character of the curves . . . seems to indicate that this is a polar elementary storm of the most typical nature; it appears to be produced by a coherent impulse, which increases to a certain size, and then again decreases to 0 . . . At the same time, as the perturbation does not make its appearance at all places simultaneously, the perturbing cause must be supposed to move with a somewhat continuous motion," p. 87. This remark has been quoted at length, because in several respects it is so suggestive of the Antarctic "special type" of disturbance, the principal difference being that the value of V in the Antarctic usually remained elevated for some time after the apparent end of the disturbance in D and H.

In Europe, as BIRKELAND says, the disturbance was small outside the Arctic. At Kew, for instance, H rose about 10 $\gamma$  between 0h. 45m. and 1h. 5m. and then fell very gradually until about 2h. 40m., the total fall being about 15 $\gamma$ . D rose about 2'·9 between 0h. 45m. and 1h. 5m. and then fell about 3'·5 to a badly defined minimum about 2h. 5m.

In the Antarctic there were some rather striking movements about three hours before the earliest time on Plate X, and one would put the commencement of the disturbances there at about 18h. 30m. on the 14th. There were, however, very sudden movements commencing about 23h. 5m. in both D and H, consisting of a rise and fall occupying in all some six minutes. H rose 22 $\gamma$  and fell 34 $\gamma$ . The D oscillation

was apparently larger, but owing to its rapidity the trace is too faint to follow to the turning-point. Simultaneously there was a very sudden rise of  $20\gamma$  in V, which was preceded and followed by slower movements in the opposite direction. On examining Plate X one observes a small sudden movement at least approximately synchronous with these Antarctic movements at Matotchkin Schar, Dyrafjord, and the American stations, but it cannot be identified with certainty in the Kew curves. There was no record obtained in the Antarctic from 23h. 56m. on the 14th until 0h. 19m. on the 15th. After the latter hour, however, there was a deep bay on the D curve, the element rising 99' between 0h. 33m. and 1h. 11m., and falling 106' between 1h. 11m. and 2h. 12m. H rose  $48\gamma$  between 0h. 53m. and 1h. 23m.; the trace then went off the sheet on the positive side, remaining off until 2h. 33m. After coming on for a few minutes, it was again off until 3h. V rose  $65\gamma$  between 0h. 47m. and 1h. 23m., and then fell  $36\gamma$  between 1h. 23m. and 2h. 8m.

These movements, it will be observed, occur about the time of the principal movements in BIRKELAND'S Arctic stations. On their conclusion the Antarctic curves were relatively quiet during the next 12 hours.

§20. December 24-25, 1902 (hours 23-5, Plate XI).

This disturbance is included amongst the "compound." In temperate Europe BIRKELAND says, p. 165, "the conditions are slightly disturbed from 23h. on the 24th to 5h. on the 25th. There are especially distinct perturbations about midnight, and from 2h. 30m. to 4h." In Toronto and at Baldwin and Cheltenham, U.S., the perturbation is practically confined, BIRKELAND says, to the short interval 3h. 14m. to 3h. 57m. on the 25th, with maximum at 3h. 21m. At Dehra Dun, Batavia, and Christchurch 3h. to 4h. is also decidedly the most disturbed time. The Arctic stations are as much disturbed between 23h. on the 24th and 0h. 15m. on the 25th as they were later, while temperate European stations are also sensibly disturbed at the earlier hour. BIRKELAND concludes, p. 165, that in Europe, as a whole, the conditions "are in the main connected with the polar storms at the Norwegian (*i.e.* Arctic) stations."

The disturbance at the non-polar European and Asiatic stations was really very trifling. At Kew the only changes in D at all conspicuous were a rise of 1'2 between 23h. 5m. and 23h. 18m., followed by a fall of 1'6 between 23h. 24m. and 23h. 35m. on the 24th, and a rise of 2'6 between 3h. 14m. and 3h. 21m., followed by a fall of 2' ending about 4h. 5m. on the 25th. In H there was a rise of  $9\gamma$  between 3h. 34m. and 3h. 55m. on the 25th. The other changes hardly catch the eye.

In the Antarctic it was rather quieter than usual for 2 or 3 hours prior to 23h. on the 24th. There then ensued a decidedly more disturbed time, extending from about 23h. 15m. on the 24th to 0h. 13m. on the 25th. Between 23h. 15m. and 23h. 54m. D rose 28', fell 84' and rose 57'. H, during this time, had a total range of only  $45\gamma$ , but there was rather a prominent double oscillation composed of a rise of  $38\gamma$  in 4 minutes, a fall of  $45\gamma$  in 6 minutes, a rise of  $42\gamma$  in 9 minutes, and a fall of  $24\gamma$  in 8 minutes. Between 23h. 19m. and 23h. 56m. V fell  $40\gamma$  and rose  $53\gamma$ . Owing to the trace coming on, the clamp, there was no Antarctic record from 0h. 18m. until the new sheet was put on at 0h. 55m. on the 25th. Conditions were distinctly quiet for over an hour after this. The H trace was off the sheet on the positive side from 2h. 23m. to 4h. 48m., so there may have been high values in that element. Between 2h. 15m. and 4h. 19m. D fell gradually 130', but a very appreciable fraction of this must be ascribed to the regular diurnal variation. The fall was interrupted as usual by a good many minor oscillations, the largest retrograde movement being a rise of 26' between 3h. 12m. and 3h. 21m. The V trace showed no large oscillations, but there were a number of minor oscillations between 3h. 20m. and 4h. 35m.

The Antarctic movements are synchronous with and larger than those seen at the American and non-polar European stations.

The reader should, however, be warned that one would not naturally regard any portion of the time covered by Plate XI as more than usually disturbed in the Antarctic, with the exception of the last hour of the 24th. At the same time, the end of Plate XI answers to the early afternoon in the Antarctic, and the diurnal changes at Midsummer were then so rapid that irregular disturbances appeal less to the eye than at most hours of the day.

§21. December 26-27, 1902 (hours 18-2, Plate XII).

This is included amongst the "polar elementary" storms. From the discussion on p. 137 we learn that it comprised two distinct "elementary" storms, the first especially powerful at Matotchkin Schar, having

a maximum at about 20h. 45m. to 21h., the second especially powerful at Dyralfjord, being most developed between 22h. 30m. and 24h. There is also a somewhat vague reference to a "more lengthy perturbation" as covering the time of the two polar storms, and to the possibility of "cyclo-median" perturbations being felt in lower latitudes.

At the time of the first "polar elementary" storm the most prominent feature at Kew was a bay on the D curve. The element fell 4'·2 between 20h. 36m. and 20h. 46m., and then rose gradually to about its original value at about 21h. 45m., the rate of recovery slackening after 21h. 10m. H rose about 7 $\gamma$  between 20h. 45m. and 20h. 57m., having been falling slowly for some time previously.

At the time of the second "polar elementary" storm the most prominent feature at Kew was a bay on the H curve, the value of the element rising and falling about 14 $\gamma$  between 23h. 8m. and 23h. 48m. In D there was a rise of about 1'·5 between 23h. 0m. and 23h. 15m., followed by an equal fall and a further small rise. After midnight on the 26th one would ordinarily describe the curves as very quiet. The conditions at Kew appear fairly representative of the European non-polar stations.

The Antarctic curves were unmistakably disturbed after 19h. on the 26th until the sheet was removed at 23h. 31m. The disturbance commenced apparently with a very rapid rise in D, the value increasing 141' in 6 minutes from 18h. 59m. to 19h. 5m. After some small rapid oscillations D continued to rise until 19h. 15m., the total rise since 18h. 59m. being 158'. This was followed by a fall of 196' between 19h. 15m. and 19h. 53m., and a second rise of 224' between 19h. 53m. and 20h. 55m., the trace then going off the sheet on the positive side for a few minutes.

H commenced to fall at 18h. 59m., when D began to rise, and fell 79 $\gamma$  in about 9 minutes, shortly thereafter getting beyond the limits of registration on the negative side. The largest change shown in H was between 20h. 27m. and 21h. 53m., when the element rose 160 $\gamma$  in several steps interrupted by minor oscillations.

The V trace during this time showed numerous oscillations, including the following (+ denotes a rise, - a fall):—

	h.	m.	to	h.	m.	$\gamma$ .
From	18	59	to	19	4	+22,
"	19	4	"	19	16	-68,
"	19	16	"	19	24	+40,
"	19	24	"	19	31	-65,
"	19	31	"	19	36	+36,
"	19	36	"	19	46	-29,
"	20	7	"	20	33	+47,
"	20	33	"	20	48	-33,
"	20	57	"	21	13	-49.

After 21h. 45m. there were further considerable movements in the Antarctic, the most notable being on two occasions when the traces from the three elements show deep bays, occurring synchronously or very nearly so. On the first occasion, lasting from about 21h. 55m. to 22h. 30m.,

D	fell 136'	and rose 130',
H	" 89 $\gamma$	" 69 $\gamma$ ,
V	" 120 $\gamma$	" 112 $\gamma$ .

The turning-points (minima) occurred within a few minutes of one another.

On the second occasion the oscillation was apparently not quite completed when the paper was changed. So far as recorded, it lasted from about 22h. 56m. to 23h. 31m. During it

D	rose 33'	and fell 39',
H	" 52 $\gamma$	" 66 $\gamma$ ,
V	" 23 $\gamma$	" 37 $\gamma$ .

The second movement is comparatively small, and is mentioned chiefly because the three elements appear approximately in phase and the time synchronises with that of BIRKELAND'S second "polar elementary" storm.

For some time after 23h. 50m. on the 26th, when the next sheet was put on, there were some fair movements, notably some rapid nearly synchronous oscillations in the traces of the three elements between 0h. 20m. and 1h. 0m. on the 27th. After this the conditions became distinctly quieter.

The temperature trace was lacking or imperfectly visible during most of the time, and the V changes recorded for times prior to 21h. 30m. are not corrected for temperature. The oscillations were, however, so rapid that the uncertainty thus arising is small.

§22. December 28, 1902 (hours 3-8, Plate XIII).

This date was not given in Prof. BIRKELAND'S circular, and he had few data for it from non-polar regions except from America. He has classified the storm, p. 169, as "compound," though the phenomena at Dyrafiord, where it was largest, suggested a "polar elementary" storm, whose centre was originally somewhere to the south of Greenland, and which moved to the westward. The classification seems to have been partly determined by the fact that the time of the chief disturbance—from 4h. 40m. to 6h.—was an unusual one for the occurrence of "elementary polar" storms.

The curves reproduced from the European co-operating stations include only D and H from San Fernando and D from Stonyhurst. The Kew D curves between 4h. 30m. and 6h. 30m. showed two wave-like movements; in each a rise of about 1'5 was followed by a more gradual fall, the crests coming at about 4h. 50m. and 6h. 0m. The H curve also showed two waves, H falling about 6 $\gamma$  between 4h. 30m. and 4h. 50m., and rising 7 $\gamma$  between 4h. 50m. and 5h. 15m., then falling 5 $\gamma$  between 5h. 15m. and 5h. 30m., and rising very slowly about 5 $\gamma$  to a maximum near 6h. 20m.

There was a somewhat larger disturbance at Kew about midnight on the 27th, but it precedes the time covered by Plate XIII. The movements lasted from about 21h. on the 27th to 0h. 30m. on the 28th.

In the Antarctic the most notable phenomenon was a deep bay on the D trace, of the same character as appeared during the "special type" of disturbance. The element began to fall suddenly about 5h. 13m. and in 13 minutes fell 90', going off the sheet on the negative side and remaining off for 11 minutes. During the next 12 minutes it was off and on the sheet once or twice, and then continued to rise with minor oscillations. The rise was not so rapid as the fall, and owing to the minor oscillations it is difficult to assign a definite time for the conclusion. D had, however, returned to its original value by about 6h. 20m.

H was off the sheet on the positive side from 3h. 35m. to 6h. 25m., and so far as that element was concerned the disturbance might have been of the "special type." The V trace, however, was not of that type. There was a rapid fall of 18 $\gamma$  between 5h. 14m. and 5h. 19m., followed by a rise of 29 $\gamma$  between 5h. 19m. and 5h. 37m. But during the rise there were numerous small oscillations which continued until 6h. 20m.

The Antarctic curves, it may be added, were somewhat highly disturbed on the 27th, from 16h. 15m. until 23h. 55m., when the sheet was taken off.

§23. January 26, 1903 (hours 7-15, Plate XIV).

During this time the Antarctic magnetographs were not in action.

§24. January 26-27, 1903 (hours 18-7, Plate XV).

This "compound" storm appears in Europe outside the Arctic as "a long perturbation . . . lasting from about 18h. 0m. on the 26th . . . to 7h. 0m. on the 27th . . . We have . . . three . . . sharply defined intermediate storms," p. 287. These "intermediate" storms are said to coincide, on the whole, in time with three storms recorded in the Arctic, especially powerful at Axelöen.

The last, however, of these three "intermediate" storms attained its maximum about 0h. 35m. on the 27th, and the Antarctic records do not commence until 1h. 5m. By this time there was comparatively little disturbance except in the Arctic, and even there it was much reduced.

In the Antarctic after 1h. 5m. there was a fall in progress in D until 4h. 8m., when the curve got off the sheet for a few minutes. A fall is what we should expect in the ordinary course of events, but the fall shown between the hours mentioned, 198', is notably in excess of the average. The fall in D was interrupted as usual by minor oscillations. The most conspicuous of the retrograde movements, one of 57', took place between 2h. 23m. and 2h. 46m. The D trace was off the sheet between 5h. 25m. and 6h. 0m., and the form of the curve when going off and coming on is not inconsistent with the existence of a bay of considerable depth.

On the H trace there were some fairly large oscillations, but only partly shown. H rose  $56\gamma$  between 1h. 13m. and 1h. 26m.; the trace was then off the sheet for 21 minutes on the positive side. Between 1h. 47m. and 2h. 31m. H fell and rose  $53\gamma$ , the trace again going off the sheet. Between 4h. 16m. and 5h. 13m. H rose  $105\gamma$ .

The V trace was, on the whole, quiet. It contained, however, a small bay from about 1h. 13m. to 1h. 48m., V rising and falling about  $19\gamma$ .

§25. February 8, 1903 (hours 8–12, Plate XVI; and hours 13–24, Plate XVII).

Before discussing this disturbance BIRKELAND mentions, p. 187, that conditions in the Arctic had been on the whole very quiet since the end of November, 1902, until February 7, 1903. On that day, he says, a fairly powerful storm was experienced in the Arctic from 21h. 5m. on the 7th until about 1h. on the 28th. There was, I may add, also marked disturbance in the Antarctic at the same time, but it commenced earlier, about 19h. 30m. on the 7th.

The disturbance of February 8 is classed amongst the "compound." It is regarded as divisible into three sections, the first of which covers the time to which Plate XVI refers. As this section is allowed a separate plate, and there is a gap of an hour between the times represented by the two plates, I shall treat the two parts separately. During his Section (i) BIRKELAND remarks, p. 187, that "The perturbation is particularly powerful at Sitka, and is (there) especially violent from 9h. to 9h. 35m." It continued to be considerable at Sitka until 11h., but ran a rather irregular course there and at the Arctic stations. BIRKELAND adds, p. 188, "The simple conditions found between San Fernando in the west and Zi-ka-wei in the east, and between Kew in the north and Batavia in the south, form a strong contrast . . . the perturbation is throughout chiefly in H. It is well defined, and, as far as we can determine, commences everywhere simultaneously at about 8h. 35m. . . . It terminates simultaneously at about 10h. 50m." The time of maximum at the co-operating stations outside North America is given as from 10h. 0m. to 10h. 10m.

BIRKELAND, p. 189, considers that the phenomena at the American stations suggest "a polar elementary storm, at first not very far north-east of Sitka," but this could not, he says, account for the phenomena "over the district between Kew and Batavia," which suggest a "negative equatorial storm," *i.e.* a disturbance due "to a current round the Earth from east to west . . . at a distance from the Earth of at least a magnitude equal to the radius of the Earth." If I rightly follow him, the view he finally inclines to, p. 189, is "that at first the perturbation partakes most of the nature of a cyclo-median storm, and subsequently changes into a more purely polar one."

At the non-polar European stations the phenomena were similar to those at Kew. There H fell gradually about  $40\gamma$  between 8h. 35m. and 10h. 0m., and then rose  $30\gamma$  between 10h. 0m. and 10h. 50m. For some reason which I do not understand, BIRKELAND, p. 188, regards this as the end of the storm at Kew, and elsewhere, during his Section (i). But as a matter of fact the Kew H curve began to fall again slightly immediately after 10h. 50m., and between 11h. 20m. and 11h. 50m. it rose  $17\gamma$ , falling  $14\gamma$  during the next 30 minutes. The trace was quieter for a short time after 12h. 20m. The D trace at Kew showed a rise of from 2' to 2'·5 above the normal between 9h. 30m. and 10h. 40m. D was, if anything, falling at 10h. 50m., the normal change at that hour being a rise. Decidedly the most conspicuous movement was a rise of 4'·8 between 11h. 35m. and 11h. 55m. There was a fall of 3'·5 between 12h. 0m. and 12h. 40m.

In the Antarctic the working of the V magnet appears doubtful. The H trace was off the sheet on the positive side, except during a few minutes, until 8h. 56m. Between 9h. 38m. and 10h. 39m. the trace shows a prominent to-and-fro movement—a fall followed by a rise—strongly suggestive of the special type of disturbance. The full extent of the movement is not shown, as the trace was beyond the limits of registration on the negative side for some 15 minutes, but the amplitude exceeded  $68\gamma$ . The turning-point, a minimum, must have occurred within a few minutes of 10h. 0m. The D trace was off the sheet at this time on the negative side, having been off since about 8h. 10m., and did not appear until 10h. 53m. It went off and came on steeply, suggesting a deep bay or bays.

Between 10h. 53m. and 11h. 33m. D rose 82'. Between 11h. 33m. and 12h. 25m. it executed a to-and-fro movement, somewhat suggestive of the special type of disturbance, a fall exceeding 82' being followed by a rise of over 105'. The trace was off the sheet only for a minute or two, the turning-point coming at

about 11h. 50m. The H trace shows a bay synchronous with that on the D trace, H rising as D fell and conversely, but the H movements were relatively small, the rise being  $17\gamma$ , the fall  $25\gamma$ .

It will be noticed that the large bay in the H curve occurs during the time of the first movements at Kew and elsewhere, while the bay in the D curve synchronises closely with the disturbance recorded at Kew near noon.

BIRKELAND, p. 190, says that his Section (ii) extends from 14h. to 18h., but Plate XVII begins at 13h., and the disturbance is said to commence at more than one place at 13h. 45m. The conclusion drawn, p. 191, is that the perturbations represent "a series of short, principally polar impulses with somewhat changing centre."

The disturbances in the Arctic are not very striking, but there is a considerable movement at Sitka, Kaafjord, and Matotchkin Schar with a maximum about 14h. 40m. This is also about the time when the departure from the normal is largest at the non-polar stations. At Kew H fell  $17\gamma$  between 14h. 28m. and 14h. 44m., and then returned gradually to the original value at about 15h. 50m.

BIRKELAND'S Section (iii), 18h. to 23h., had for its principal feature in the Arctic a "violent storm . . . at all the . . . stations simultaneously, most powerful at Axelöen and Matotchkin Schar," p. 192. The time of commencement of this powerful storm is said to vary from 18h. 33m. at Dyrafjord to 19h. 7m. at Axelöen, the time of ending being about 22h. 30m. The intensity appeared to be greatest between 19h. 15m. and 20h. 15m.

At the non-polar stations the disturbance was mainly from 19h. 5m. to 20h. 30m., the maximum being placed by BIRKELAND at 19h. 18m. At Kew the range between 19h. and 20h. was  $48\gamma$  in H and  $14' \cdot 5$  in D; the most prominent movements were a rise of  $44\gamma$  in H from 19h. 18m. to 19h. 30m., and a fall of  $14'$  in D from 19h. 5m. to 19h. 24m.

In the Antarctic it does not seem possible to draw any line corresponding to BIRKELAND'S division into Sections (ii) and (iii). There was a comparatively quiet time for about half an hour prior to 13h., but thereafter there was a constant succession of large movements until after the time included in Plate XVII. The largest of several considerable oscillations in D during BIRKELAND'S Section (ii) consisted of a fall and rise each about  $84'$  between 13h. 33m. and 14h. 28m. During BIRKELAND'S Section (iii) there were larger, but not more rapid movements. Between 18h. 47m. and 20h. 40m. there was a sort of bay in the D trace, a rise of  $189'$  being followed by a fall of  $151'$ . The decreasing movement which began about 20h. 5m. was interrupted by a rise of  $78'$  between 20h. 41m. and 21h. 13m. When resumed, it continued until 22h. 21m., the value of D at that hour being  $261'$  below that at 20h. 5m. Between 22h. 37m. and 23h. 34m. D rose  $110'$ .

The H trace was off the sheet on the negative side, most of the time from 14h. 10m. until 21h. 20m. Its longest appearance was from 16h. 28m. to 17h. 42m., when it rose and fell  $68\gamma$ , with numerous minor oscillations. The chief turning-point (a maximum) was at 16h. 53m. After 21h. 20m. the H trace remained on the sheet until the end of the 8th. There was rather a rapid rise of  $52\gamma$  between 21h. 20m. and 21h. 33m., followed by a slower motion in the same direction interrupted by numerous oscillations. The total range in H between 21h. 20m. and 24h. 0m. was  $101\gamma$ .

§26. February 10-11, 1903 (hours 20-3, Plate XVIII).

This is classed amongst the "polar elementary" storms. Of it BIRKELAND says, p. 106, "This magnetic disturbance is brief, and commences without any previous equatorial perturbation on an otherwise very quiet day. First a small disturbance appears rather suddenly at about 21h. 6m. . . . most powerful at the northern stations . . . but is also perceptible in (temperate) Europe and North America. After about 30 minutes, the conditions are once more almost normal . . . The powerful perturbation . . . does not commence until 23h. . . . After about an hour and three-quarters the storm is over . . . At 2h. 30m. on the 11th February another short, slight perturbation appears . . ."

On p. 107 BIRKELAND gives a table containing his estimate of the times of beginning and ending and of the maximum for the principal storm, and also the value of  $P_1$ , the maximum disturbing force in the horizontal plane. At the non-polar stations the beginning is put at about 23h. 0m., the maximum at about 23h. 20m. The end is given for the non-polar European stations as 1h. 0m. on the 11th. In the Arctic the times of beginning and ending are more variable, but do not depart much from those

already given; the maximum appears about half an hour later than elsewhere.  $P_1$  is said to vary from  $373\gamma$  at Matotehkin Schar to less than  $5\gamma$  at Batavia. It is given as  $35.8\gamma$  at Kew, a value similar to that assigned to the other non-polar European stations.

Commenting on the fact that the value of  $P_1$  at Christchurch,  $12\gamma$ , is larger than the values at Honolulu, Zi-ka-wei, and Batavia, BIRKELAND says, p. 108, "This may be explained by the fact that the perturbation in the Arctic regions is often accompanied by simultaneous perturbations in the Antarctic regions, and it is the effect of these latter that is noticed in Christchurch. Our material does not, however, allow of certain conclusions being drawn in this matter."

As BIRKELAND does not seem to have had any records from south of Christchurch, the above is presumably pure surmise.

At Kew the short commencing movement was represented by a fall of  $5\gamma$  in H between times which I make 21h. 8m. and 21h. 16m., and by a bay lasting from 21h. 8m. to 21h. 35m. in the D curve, the element falling  $1.9$  and rising  $1.0$ .

The principal disturbance at Kew was represented in H by a rise of  $29\gamma$  from 23h. 4m. to 23h. 19m., a fall of  $41\gamma$  from 23h. 19m. on the 10th to 0h. 16m. on the 11th, and a rise of  $13\gamma$  from 0h. 16m. to 0h. 45m. In the D curve there was a bay from about 23h. 0m. on the 10th to 0h. 40m. on the 11th, the element being depressed. The maximum depression occurred about 23h. 40m. and amounted to  $5.2$ .

In the Antarctic, after being comparatively undisturbed for over 12 hours, the traces became distinctly disturbed about 18h. 36m. on the 10th, or  $2\frac{1}{2}$  hours before the commencing disturbance noted by BIRKELAND, and the disturbance continued without appreciable intermission until 23h. 0m., when the lamp went out. When registration was resumed at 0h. 11m. on the 11th the disturbance appeared much reduced. The period for which trace is lacking includes unfortunately the major part of BIRKELAND'S principal storm.

The commencing movement in the Antarctic was a rapid fall of  $72\gamma$  in H between 18h. 36m. and 18h. 53m. The most striking movement, however, prior to Plate XVIII, was an oscillation which appeared simultaneously in D, H, and V. The turning-point, a maximum, occurred at about 19h. 46m. In the course of about 14 minutes D rose  $70'$  and fell  $54'$ , H rose and fell  $39\gamma$ , while V rose  $25\gamma$  and fell  $33\gamma$ . There is, however, no distinct movement at this time in the Kew curves.

During the time covered by Plate XVIII the largest Antarctic movements were as follows, + denoting a rise and - a fall in the element :—

D.			H.			V.		
h. m.	h. m.	'	h. m.	h. m.	$\gamma$	h. m.	h. m.	$\gamma$
From 20 47	to 20 56	+ 93	From 20 25	to 20 47	-56	From 19 46	to 19 53	- 33
" 20 56	" 21 26	-112	" 20 56	" 21 6	-59	" 19 53	" 20 29	+ 51
" 21 26	" 22 13	+ 93	" 21 15	" 21 43	+94	" 20 29	" 20 49	- 30
" 22 13	" 22 38	- 72	" 22 10	" 22 36	-77	" 20 49	" 20 55	+ 33
			" 0 11	" 1 1	+67	" 20 55	" 21 5	- 45
						" 21 23	" 21 35	+ 36
						" 22 3	" 22 36	-100

The H trace was off the sheet on the negative side for a few minutes after 21h. 6m., and got off on the positive side at 2h. 28m., remaining off for over  $4\frac{1}{2}$  hours.

After the new sheet was put on at 0h. 11m. on the 11th, the D and V traces appeared no more disturbed than usual.

Owing to the lack of trace our information is mainly confined to the fact that the disturbances near the commencement of Plate XVIII, which BIRKELAND ascribes to equatorial perturbations, were synchronous with large oscillations in the Antarctic, which formed part of a series which commenced about 18h. 36m., and which persisted without intermission until at least 23h. 0m.

§27. February 15, 1903 (hours 13-20, Plate XIX).

This is classified as a "compound" storm on the following grounds, p. 174, . . . "It must thus be assumed that these are in the main polar perturbations; but the conditions are not simple, indicating, as



they do, both in the Arctic regions and in lower latitudes, that there are a number of systems acting to some extent simultaneously."

According to BIRKELAND, one noteworthy peculiarity is that the disturbance at most stations commenced nearly 2 hours later, while ending nearly half an hour earlier in D than in H.

In Europe, outside the Arctic, the H disturbance is given as lasting from about 14h. 15m. to 18h. 15m., and the D disturbance as lasting from about 16h. 10m. to 17h. 45m. The time of the maximum disturbance is given at most stations as near 16h. 40m. The maximum value of the disturbing force in the horizontal plane varied, according to BIRKELAND, from  $392\gamma$  at Axelöen to  $10\cdot6\gamma$  at Honolulu, the value at Kew,  $38\gamma$ , being similar to that at most non-polar European stations.

There were no Christchurch results.

In Europe generally, outside the Arctic, the disturbance consisted of a slight depression in H from about 14h. 15m. to 18h. 15m.—the maximum depression at Kew below the normal being about  $20\gamma$  and occurring about 16h. 30m.—and of a more conspicuous depression in D. At Kew there was a fall of  $6\cdot5$  in D between 16h. 10m. and 16h. 45m., followed by a rise of  $4\cdot8$  between 16h. 45m. and 17h. 20m. After a stoppage of nearly 20 minutes there was a further rise of about  $2'$  going on until nearly 18h. 30m. This final rise, however, is so slow that opinions might well differ as to its duration and significance.

In the Antarctic the curves would hardly be described as disturbed before 16h. Between 13h. 41m. and 14h. 53m., however, D rose  $66'$ , while H fell  $64\gamma$  between 13h. 17m. and 14h. 53m. There were two successive bays on the D curve, the first from 16h. 3m. to 17h. 10m. with a rise of  $51'$  and fall of  $31'$ , the second from 17h. 10m. to 18h. 10m. with a fall of  $52'$  and rise of  $57'$ . The H trace, which had been off the sheet on the negative side for about 45 minutes, came on the sheet at 17h. 23m., and H rose  $63\gamma$  by 17h. 50m. Following this were a number of oscillations of some size, H rising on the whole until 19h. 33m., the total rise since the trace came on the sheet at 17h. 23m. being about  $105\gamma$ . During this time the V trace shows two fairly prominent bays, the first lasting from 15h. 53m. to 17h. 5m., the second from 17h. 5m. to 18h. 13m. The first bay represents a rise and fall of about  $25\gamma$ , the second a rise and fall of about  $48\gamma$ .

Up to 18h. 40m. there were no very rapid movements. Between 18h. 40m. and 18h. 55m., however, there were simultaneous rapid oscillations in D and H; D rose  $52'$  and fell  $48'$ , while H fell  $62\gamma$  and rose  $75\gamma$ . During part of this time, from 18h. 43m. to 18h. 48m., there was a smart rise of  $25\gamma$  in V. This was followed by a larger but slower fall of  $32\gamma$  from 18h. 48m. to 19h. 3m.

Conspicuous movements in D and H were just concluding at 20h. 0m., the hour answering to the end of Plate XIX. D had risen  $42'$  in the course of the previous 11 minutes, whilst H had fallen  $64\gamma$  since 19h. 46m. These movements seem, however, to be related rather to what follows than to what precedes them. For after a small retrograde movement H continued to fall to a very sharp peak at 20h. 3m., the total fall since 19h. 46m. amounting to  $81\gamma$ . The peak at 20h. 3m. answers to a depression (minimum) in V, rather suggesting that the preceding fall answered to the first phase of a disturbance of the "special type." If this view is correct, the second phase is represented by a rise of  $78\gamma$  in H and of  $23\gamma$  in V, which took place between 20h. 3m. and 20h. 16m. This was immediately followed, between 20h. 16m. and 20h. 38m., by another double movement, also suggestive of the "special type" of disturbance. The H change in this second oscillation was a fall of  $72\gamma$  and rise of  $56\gamma$ , the V change a fall of  $36\gamma$  and rise of  $43\gamma$ . This movement was followed by yet a third sharp oscillation in H and V, terminating about 20h. 54m. The range of H, however, in the third oscillation was only  $32\gamma$ , the fall and rise being equal, while the V movements were under  $20\gamma$ . During these three oscillations there were also oscillatory movements of some size in D, the total range in D between 20h. 3m. and 20h. 54m. amounting to  $50'$ . The oscillations in D were, however, much interrupted by minor oscillations, and it is difficult to decide on their exact relationship to the H and V movements.

One would put the commencement of the quiet time in the Antarctic at the end of the third oscillation, *i.e.* at 20h. 54m., and one would unquestionably regard the disturbances from 19h. 46m. to 20h. 54m. as forming part of a common system.

§28. March 22–23, 1903 (hours 12–1, Plate XX).

This is classed amongst the "elementary polar" storms, but BIRKELAND, p. 127, explains that "The

perturbation . . . is in reality . . . composed of two principal phenomena, an equatorial perturbation and a short, well-defined, comparatively powerful elementary polar storm." Of the "equatorial" perturbation he writes: "This . . . begins quite suddenly, at 12h. 58m., with an oscillation that is noticed simultaneously all over the world. In the equatorial regions, this sharp deflection . . . appears principally in H. About the auroral zone the curve oscillates, and the perturbation is noticeable both in D and H." The time at which this commencing disturbance reached a maximum is given as 13h. 4m. BIRKELAND concludes, apparently, that the small enhancement of H caused by the commencing disturbance, or at least a fraction of it, persists in low latitudes right through the subsequent polar storm until midnight. At Dyraford and Axelöen, however, he notes "a peculiar circumstance," p. 128, viz., that the commencing movement is distinctly oscillatory. The H curve, in fact, at the two stations shows a fall, a rise and then a second fall, and possibly a second, but much smaller, rise.

According to BIRKELAND'S table, p. 130, the time of commencement of the "polar" storm varied from 20h. 30m. to 21h. 30m., the time at non-polar European stations being about 21h. 10m. At most stations the termination is put at about 23h. 45m. At most non-polar European stations the maximum occurred about 22h. 10m.; in North America it was about half an hour later. The maximum value of the horizontal disturbing force is given as varying from about  $370\gamma$  at Axelöen to  $12\cdot4\gamma$  at Batavia, the value at Christchurch being too small to measure satisfactorily. The value at Kew,  $44\gamma$ , is about a mean for non-polar Europe.

My examination of the original Kew curves makes the sudden commencement 4 or 5 minutes earlier than the hour, 12h. 58m., given by BIRKELAND. But the movement appears distinctly oscillatory in both H and D, a small fall, lasting 2 or 3 minutes, preceding the rise. In the case of H the fall seems about  $1\gamma$ , the rise about  $13\gamma$ ; while in D the fall is  $1\cdot0$ , the rise  $2\cdot4$ . There are a number of small movements at Kew in both H and D throughout the remainder of the 22nd, but much the most conspicuous phenomenon is a bay on the D curve from about 21h. 6m. to 23h. 50m., the element being depressed in value. The largest value of the depression is about  $8\cdot8$  and it occurred about 22h. 5m.

Looking at the curves in Plate XX, it is easy to recognise in most, if not all, a second movement which somewhat resembles the commencing movement both in size and character, and which occurred about an hour and fifty minutes later. At Kew this second movement occupied some 14 minutes. During it H fell  $4\gamma$  and rose  $10\gamma$ , while D fell  $0\cdot8$  and rose  $1\cdot0$ , the turning-point in each case coming at about 14h. 46m. The reason for mentioning this is because on looking at the Antarctic curves one's eye is caught by two oscillatory D movements larger than their neighbours, occurring during an otherwise somewhat unusually quiet time. So far as I can judge, these movements correspond in time to the commencing movement and the second movement just referred to. The following are the results of the measurement made of the two groups of movement (+ denotes a rise, - a fall):—

	D.				H.				V.						
	From	h. m.	to	h. m.		From	h. m.	to	h. m.		From	h. m.	to	h. m.	$\gamma$
Group I.		12 54		12 57	+20		12 55		13 0	- 5		12 56		12 59	+ 4
	"	12 57	"	13 6	-42	"	13 0	"	13 4	+ 5	"	12 59	"	13 4	- 9
	"	13 6	"	13 13	+15										
Group II.	"	14 42	"	14 46	+38	"	14 46	"	14 52	+16	"	14 45	"	14 49	+10
	"	14 46	"	14 54	-47	"	14 52	"	14 57	-17	"	14 49	"	14 56	-17
	"	14 54	"	15 5	+34										

In each case it is a little doubtful whether the final rise in D forms part of the same system as the preceding rise and fall. The H movements do not stand out very conspicuously, and it is mainly their approximate coincidence in time with the others that has led to their enumeration. The V movements, though small, do stand out.

Unless we assume an accidental coincidence of a truly remarkable kind, the conclusion seems inevitable that the above two groups of movements are due to the same cause as the movements seen at Kew and elsewhere at the same times. If this be so, then the fact that the Antarctic movements represent

disturbing forces much larger than those shown by the curves in equatorial and temperate latitudes is a fact which requires a good deal of explanation on the hypothesis of *equatorial* electric currents.

From 15h. 5m. to 18h. 15m. the Antarctic curves, like those elsewhere, were, on the whole, distinctly quiet. From 18h. 15m. to 18h. 25m. there was a more prominent oscillation in H, a fall of  $14\gamma$  being followed by a rise of  $16\gamma$ , while V rose  $16\gamma$  between 18h. 22m. and 18h. 26m.

Between 19h. 13m. and 19h. 22m. H fell  $20\gamma$  and rose  $24\gamma$ , while between 19h. 32m. and 19h. 35m. it rose  $16\gamma$  and fell  $17\gamma$ , the latter an exceptionally rapid though not large oscillation.

After 20h. 15m. conditions became more disturbed in all the elements. The oscillations, though not really large, were unusually rapid between 20h. 15m. and 22h. 15m.

The D and H traces got rather mixed up and are difficult to distinguish. Amongst the movements in the V trace after 20h. were—

a fall of  $16\gamma$  between 20h. 14m. and 20h. 19m.,  
 a rise of  $24\gamma$  „ 20h. 19m. „ 20h. 24m.,  
 and a fall of  $39\gamma$  „ 20h. 24m. „ 20h. 31m.

After this there were numerous small but rapid oscillations, during whose incidence V rose to a maximum at about 21h. 13m. There then ensued a fall, interrupted by minor oscillations, which continued until about 22h. 40m., in the course of which V fell  $56\gamma$ . This was followed by a rise of  $97\gamma$  in two steps between 22h. 40m. and 23h. 25m., the rise being conspicuously most rapid during the first 20 minutes. From 22h. 20m. to 23h. 3m., simultaneously with the most rapid part of the change in V, there was a prominent bay on the H curve, the element falling  $61\gamma$  and rising  $36\gamma$ .

After 23h. the D and H traces were somewhat uncertain owing to operations connected with the clearing away of snow near the Magnet Hut, and the record was suspended altogether from 23h. 37m. to 1h. 5m. on the 23rd.

It will have been noticed that the large rise in V and the prominent bay on the H curve took place during BIRKELAND'S "elementary polar" storm.

So far as mere amplitude is concerned, the large rise in V after 22h. 40m. is, perhaps, the only phenomenon which merits the title of disturbance as judged by the Antarctic standard. The number, however, of minor oscillations in V and the rapidity of the oscillations in D and H, especially H, are certainly a little outstanding.

§29. March 30-31, 1903 (hours 19-3, Plate XXI).

This is classed amongst the "elementary polar" storms. BIRKELAND explains, however, pp. 115-117, that this "elementary" storm was preceded by an "equatorial" perturbation. He adds, p. 116: "As early as 19h., those little, sudden, very variable perturbations are noticed, which occur simultaneously all over the Earth. . . The ("equatorial") perturbation appears to be over at about 23h. 12m. . ."

The "polar" perturbation is said to be recognisable at Kaafjord about 23h., being earlier there than elsewhere. It did not commence at Dyrafjord until about 0h. 24m. At non-polar stations the commencement was, in general, about 23h. 50m., the end about 2h. 10m. on the 31st. The hour of occurrence of the maximum is given as 0h. 30m. for temperate Europe, but 0h. 58m. for Dyrafjord. The maximum value of the horizontal component of the disturbing force varied from  $546\gamma$  at Dyrafjord to  $10\cdot5\gamma$  at Batavia. The value for Kew,  $41\cdot5\gamma$ , is about a mean for non-Arctic Europe.

The earliest decided movement shown in Plate XXI at non-Arctic stations is a small oscillation apparent in almost all the H traces and in some of the D traces. At Kew the double movement lasts from about 19h. 23m. to 19h. 31m., the turning-point coming about 19h. 27m. There was a rise of  $7\gamma$  and then a fall of  $6\gamma$  in H, while D fell and then rose  $1\cdot3$ .

While examining the original Kew curves I noticed a somewhat conspicuous movement of similar size and character about an hour and fifty minutes earlier. This consisted in the case of H of a rise of  $6\gamma$  between 17h. 32m. and 17h. 36m., followed by a fall of  $9\gamma$  between 17h. 36m. and 17h. 40m. The reason for mentioning this will appear presently.

During the whole time covered by Plate XXI the most conspicuous phenomenon at Kew (and the same is true generally of the other non-polar stations) took place between 0h. 10m. and 1h. 10m. of the 31st, *i.e.* during the "elementary polar" storm. D, which had fallen  $1\cdot8$  between 23h. 45m. and 0h. 10m. on

the 31st, rose 9'·6 between 0h. 10m. and 0h. 32m., and then fell 11'·5 between 0h. 32m. and 1h. 15m. Between 1h. 15m. and 1h. 40m. there was a rise of 2', and a further very gradual rise continued until nearly 4 a.m. H fell 10γ between 23h. 45m. and 0h. 6m. on the 31st, rose 25γ between 0h. 15m. and 0h. 42m., and fell 25γ between 0h. 42m. and 1h. 27m. The only other movements on the Kew curves likely to attract attention occurred shortly after 21h., *i.e.* 2½ hours before the commencement of the "elementary polar" storm. Between 21h. 1m. and 21h. 35m. H rose 5γ and fell 12γ, then rose 19γ in two steps and fell 6γ. The D trace shows only a very small movement about 21h. 3m., consisting of a fall of 0'·8, followed by an equal rise.

The Antarctic curves had been rather quiet for some hours prior to 19h. on the 30th, but they exhibit a somewhat prominent oscillation occurring apparently simultaneously in the D, H, and V curves, all showing a sharp peak at 17h. 35m. The oscillation lasts from about 17h. 31m. to 17h. 39m. In D there is a rise and fall, each 12', in H a rise of 16γ and fall of 12γ, in V a rise and fall, each 7γ. The V movement, though small, is clearly shown, the curve being unusually quiet for some time before and after. The fall in D and H only paused for a minute at 17h. 39m. and then proceeded for some minutes, but at a slower rate. The oscillation is synchronous with the earlier movement at Kew, which occurred prior to the time considered by BIRKELAND.

The next movement in the Antarctic which catches the eye occurs between 19h. 25m. and 19h. 31m., with turning-point at about 19h. 28m. in all the elements. The D movement is small and not very distinct. It consists apparently of a fall of about 2' and a rise of 10'. H falls and rises 18γ, while V falls and rises 6γ. These movements synchronise with the second of the two movements at Kew, *i.e.* with BIRKELAND'S "equatorial" perturbation. One is rather reminded of the occurrence of the two oscillatory movements on March 22; the interval between the two movements is nearly the same on the two occasions. The movements of March 30 do not appeal so much to the eye as those of March 22.

The fact that the disturbances in the Antarctic are again larger than the corresponding ones at stations nearer the Equator will doubtless have been noted.

Though not seriously disturbed, the Antarctic curves all show oscillations of increased amplitude between 19h. 25m. and 21h. 40m. The largest movements during this time consisted of a bay, apparently simultaneous in the three traces, from about 21h. 6m. to 21h. 26m. During it D fell 35' and rose 52', H rose and fell 26γ, while V fell 25γ and rose 38γ. This movement, it should be noticed, occurred at a time when the curves at Kew and the other non-polar stations showed increased activity of disturbance.

From 21h. 40m. to 22h. 25m. there was a relatively quiet time in the Antarctic. There then ensued from 22h. 25m. to 23h. 30m. an interval during which the V trace showed a number of rather sharp oscillations, which were accompanied by more or less simultaneous oscillations in D and H, the H oscillations being of enhanced size. Several of these oscillations rather suggest the "special type" of disturbance, but their period is short and the rises in V do not exceed the falls. The two following cases gave the largest changes in V :—

From 22h. 38m. to 22h. 53m.				From 23h. 5m. to 23h. 18m.			
	D.	H.	V.		D.	H.	V.
Fall . . . . .	24	29	25	Fall . . . . .	20	35	33
Rise . . . . .	15	21	14	Rise . . . . .	20	22	17

The oscillations in V continued for some hours, but with diminished size. In the case of D and H, however, movements of increased size and duration took place.

The chief movements in D were a fall of 99' between 23h. 30m. on the 30th and 0h. 20m. on the 31st, a rise of 120' between 0h. 20m. and 0h. 56m., and a fall of 111' between 0h. 56m. and 1h. 57m. These movements were accompanied by shorter oscillations of comparatively small size.

During this time there was a large bay on the H curve, but its nature is imperfectly shown, as the trace was off the sheet on the positive side from 0h. 16m. until 1h. 7m. Between 23h. 40m., when the bay may

be said to commence, and 0h. 16m., when the trace went off the sheet, H rose  $54\gamma$ ; between 1h. 7m. and 1h. 42m. it fell  $42\gamma$ . Between 1h. 42m. and 2h. 12m. H rose  $42\gamma$ , again going off the sheet, but only for about a minute.

After 2h. 10m. the Antarctic curves were quiet, according to the Antarctic standard.

The large D and H movements observed in the Antarctic after 23h. 30m. on the 30th synchronise with BIRKELAND'S "elementary polar" storm. It is impossible to decide from the form of the curve alone at what instant D was really most remote from the normal, but this would seem to have been at the turning-point at 0h. 56m., when the maximum for the day occurred. This answers practically to noon, L.T., thus rendering possible a comparison with mean results for that hour from adjacent days. Taking a mean from the five previous days we deduce an excess on the 31st of 110', answering to about  $200\gamma$  in force. The simultaneous value of H was also substantially in excess of the normal, but how much it is impossible to say, as the trace was off the sheet and very steep both when going off and coming on. Probably the maximum value of the horizontal component of the disturbing force in the Antarctic, measured after BIRKELAND'S method, was fairly similar to that at Axelöen,  $280\gamma$ , or, say, half that at his most disturbed station, Dyraford. The disturbance of March 30-31, regarded from an Antarctic standpoint, was, of course, by no means a large one.

§30. The intercomparison of the Antarctic curves with BIRKELAND'S records points to the following conclusions:—

1. At the times of the small sudden movements which BIRKELAND assigns to "equatorial perturbations" there seem to be almost always (no certain exception has been noted) corresponding movements in the Antarctic. The Antarctic movements are larger, usually much larger, than those recorded at the equatorial or non-polar stations, and are usually, if not always, oscillatory in type.

2. At the times of BIRKELAND'S "elementary polar" storms in the Arctic, the conditions in the Antarctic are generally more than usually disturbed. The times of the largest movements in the Antarctic usually occur not far from the times of maximum disturbance in the Arctic. Not infrequently, however, the disturbances in the Antarctic continue without any marked subsidence of intensity throughout times which BIRKELAND regards as including two or more elementary polar storms.

3. In the Antarctic, the sudden commencing movements which BIRKELAND assigns to equatorial perturbations are sometimes immediately followed by disturbances which are not separated by any markedly quiet interlude from subsequent disturbances which synchronise with Arctic disturbances which BIRKELAND believes of the "elementary polar" type.

4. The "elementary polar" disturbances of BIRKELAND seem practically all confined to the hours 13 to 2, G.M.T. (or 0 a.m. to 1 p.m., Antarctic L.T.), and so occur at a time when the Antarctic movements are usually of a rapidly oscillatory character, and avoid the hours when the rounded wave-like movements of the "special type" are usually found.

Further, BIRKELAND'S results are limited to the Antarctic Summer, *i.e.* to the season at which few if any disturbances of the "special type" were recorded.

It would clearly be of great interest to know what was the nature of the phenomena in the Arctic during the times of occurrence of the Antarctic "special type" of disturbance; also whether the Arctic stations show a marked diurnal variation in the type of disturbance corresponding to that seen in the Antarctic.

One of the results of the comparison has been to make me realise even more clearly than before the desirability of much reduced sensitiveness in magnetographs intended for use in polar regions. It is clear that most fundamentally important results might be hoped for if simultaneous *complete* records were obtainable from a series of stations in the Arctic and Antarctic regions so situated that the effects of day and night could be adequately brought out. This comparison should extend over a complete year, so as to bring out seasonal effects.

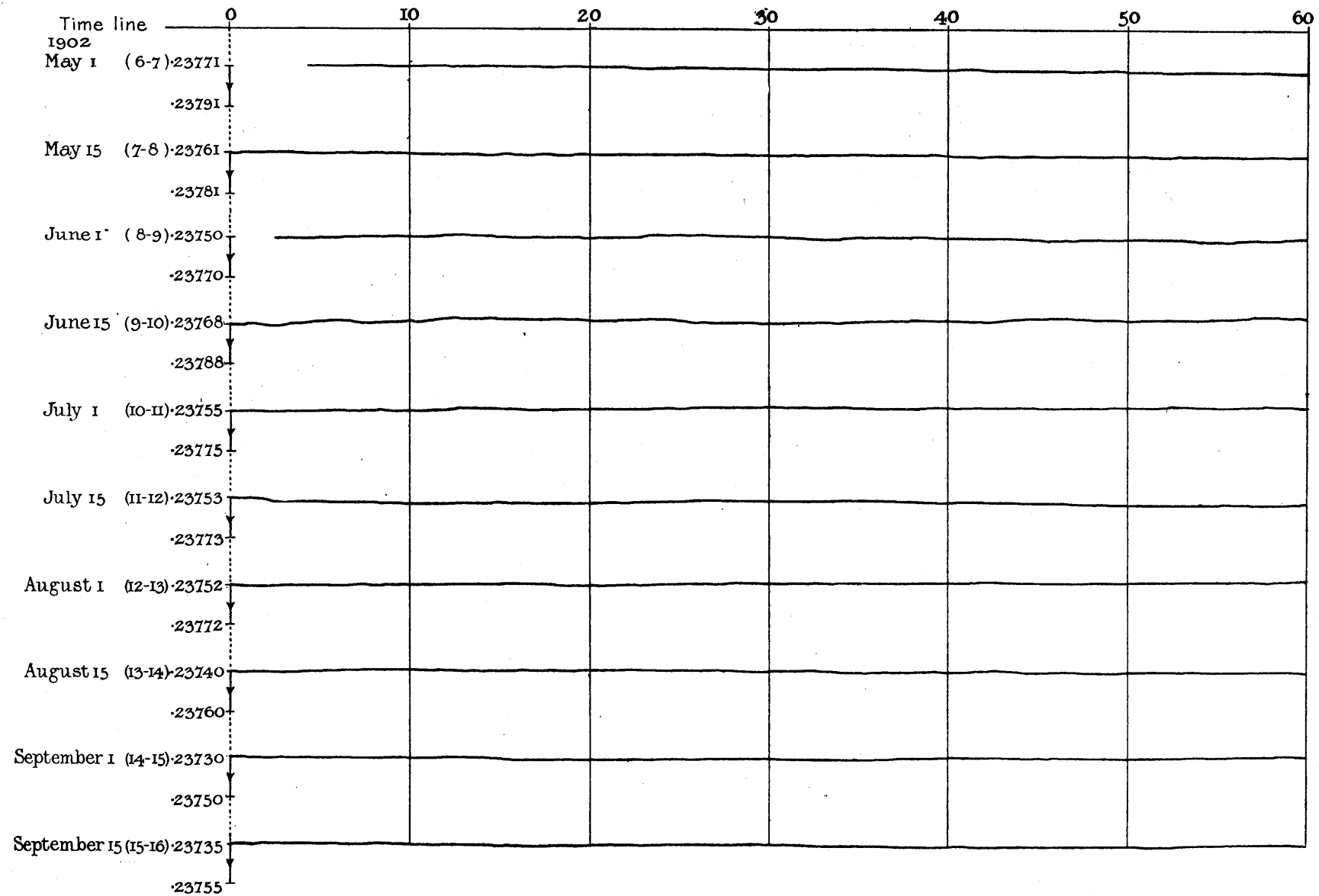

Term Hours, quick run, at Mauritius.



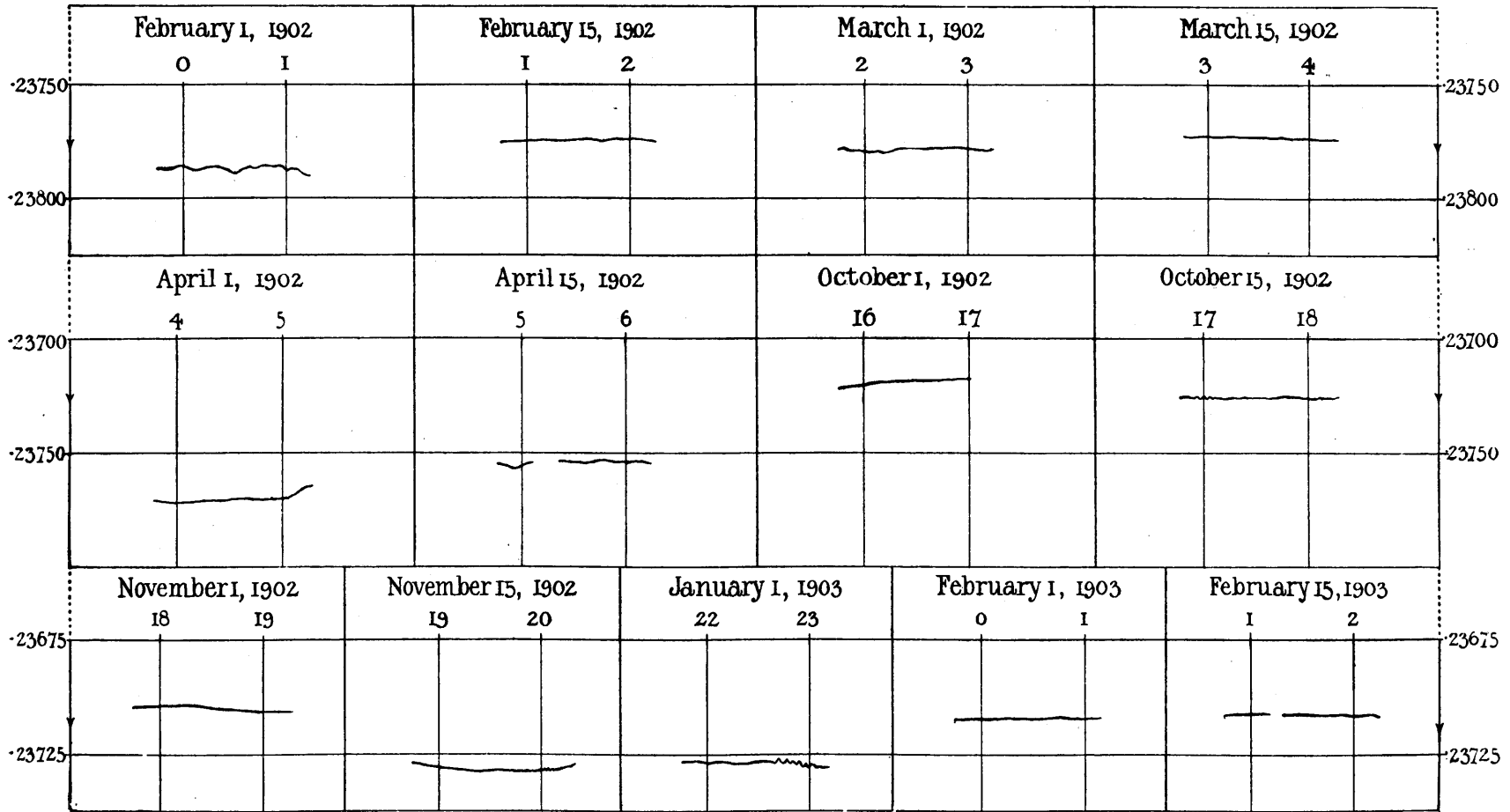

Term Hours, slow run, at Mauritius.





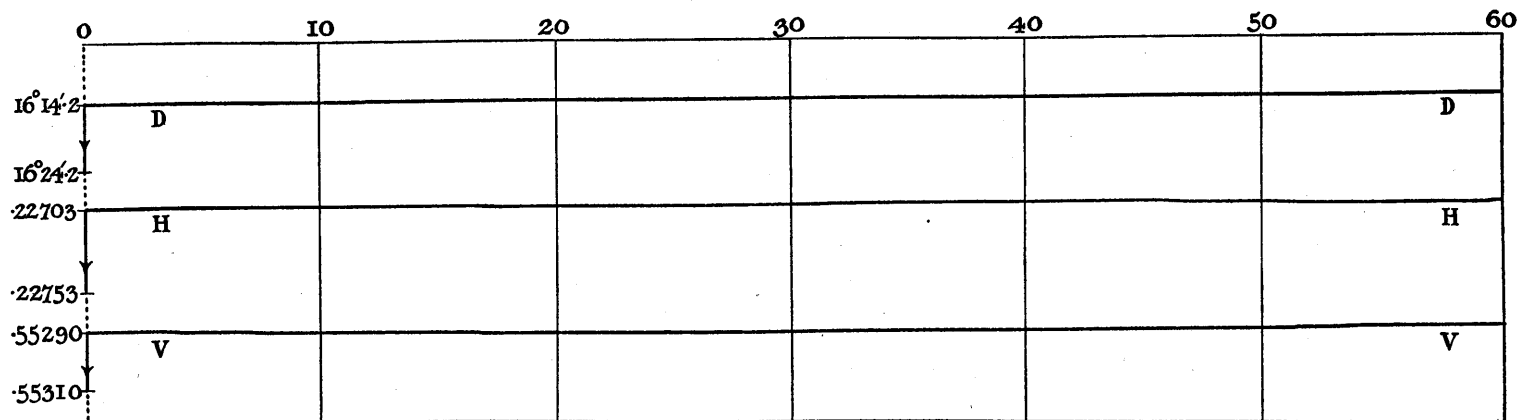

June 15, 1902, 9-10 G.M.T.

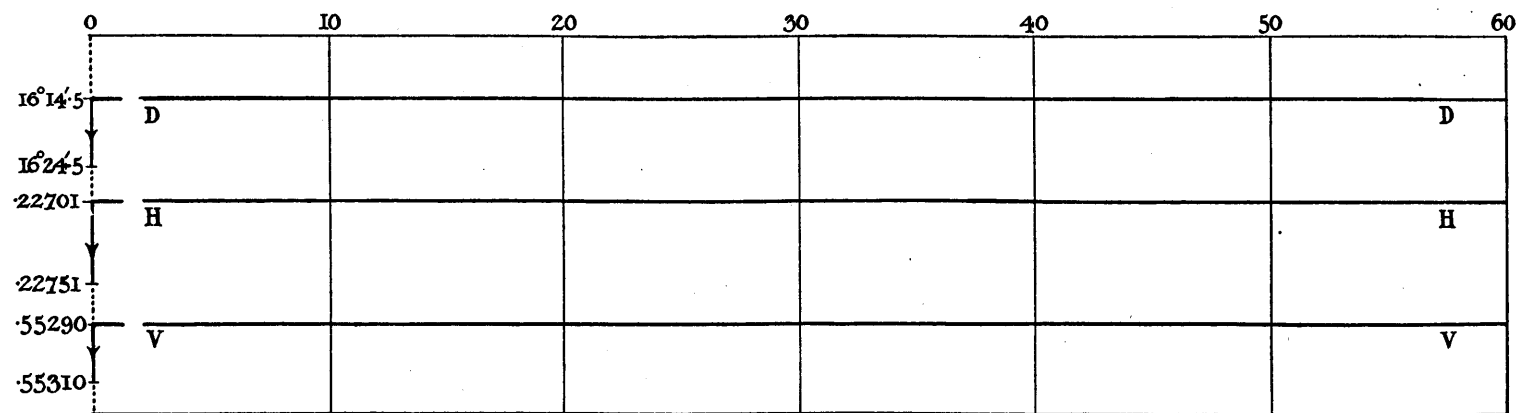

July 1, 1902, 10-11 G.M.T.

Term Hours, June 15, and July 1, 1902, at Christchurch.

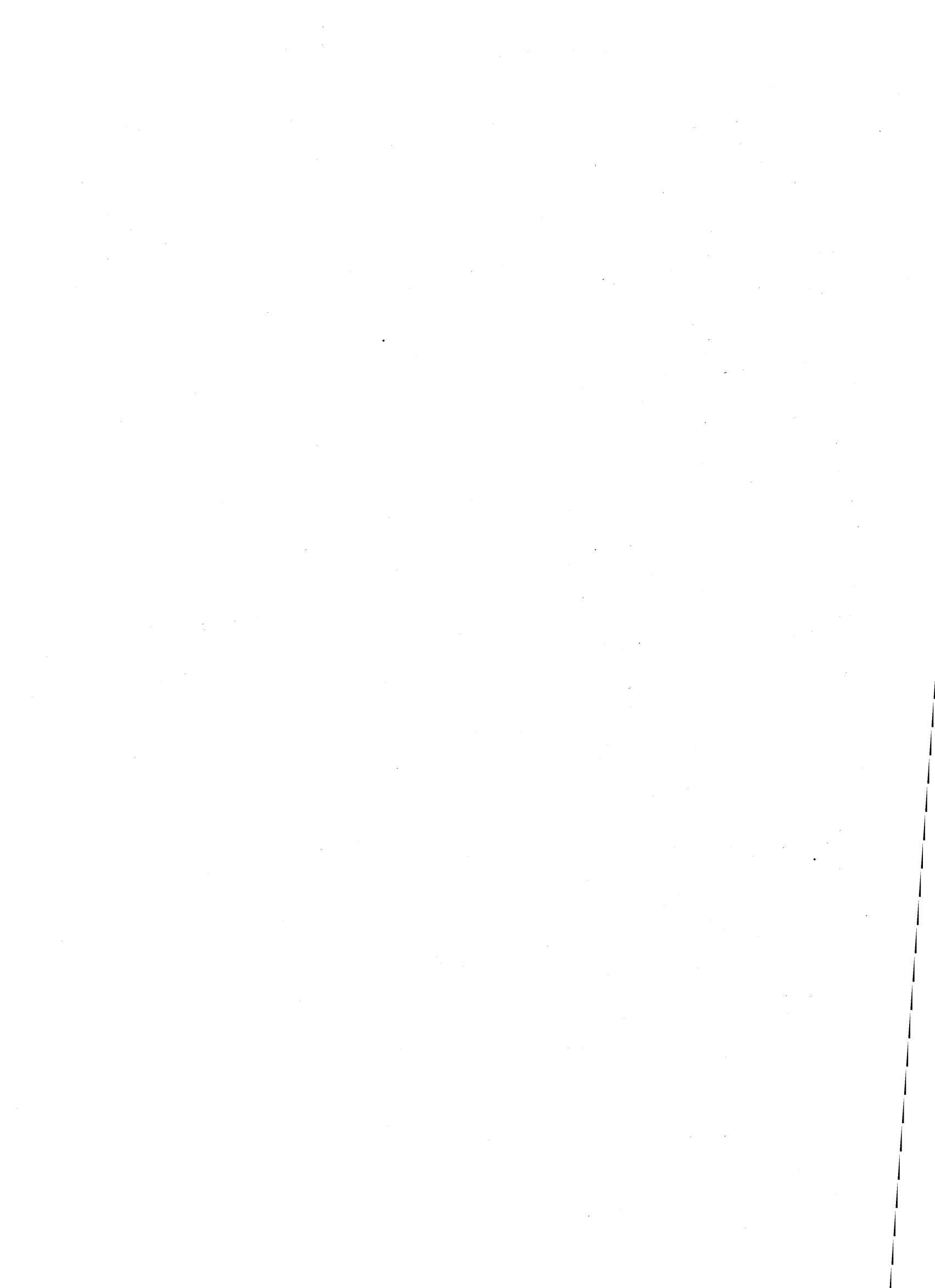

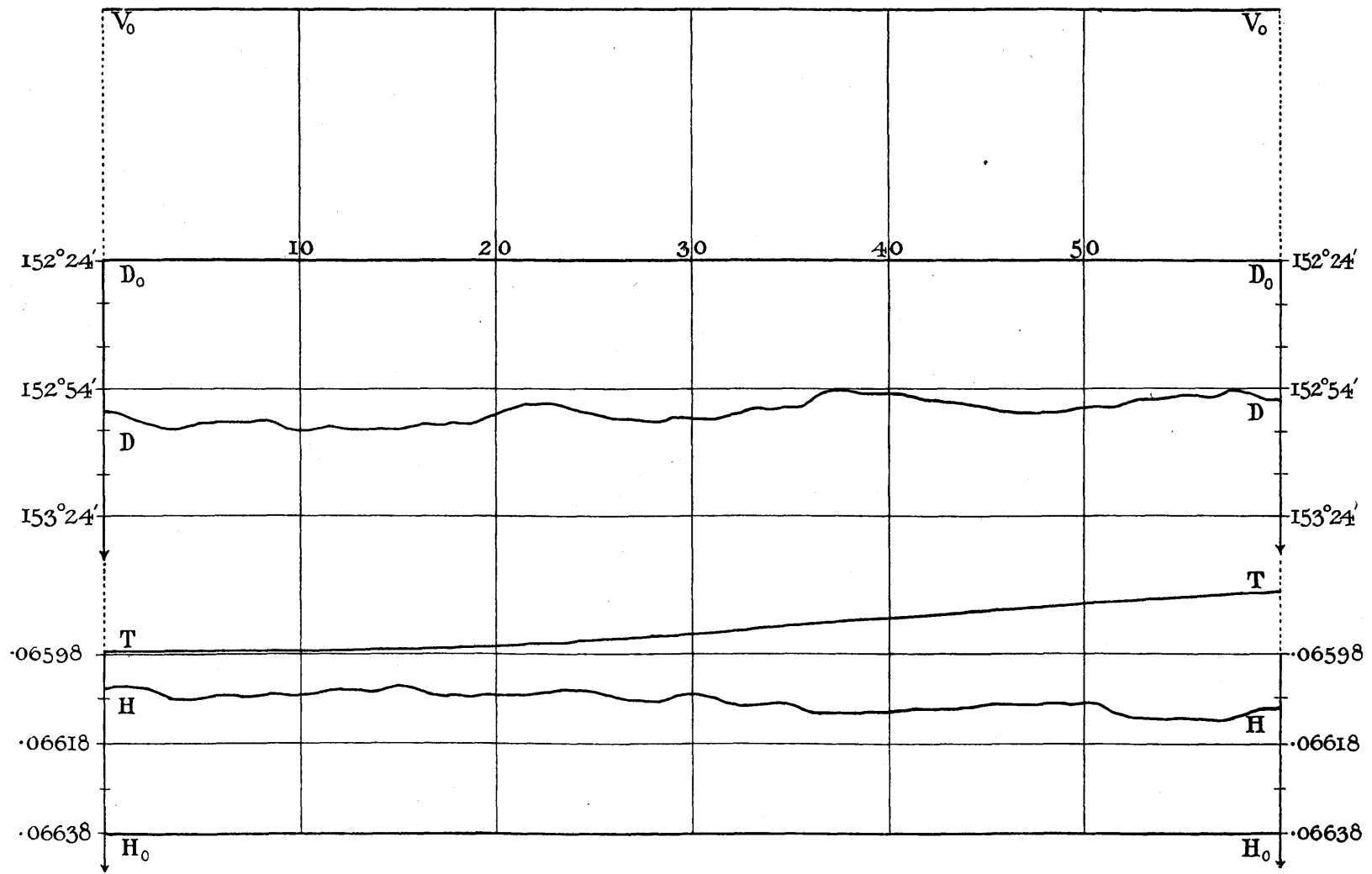

Term Hour, June 15, 1902, at Winter Quarters.



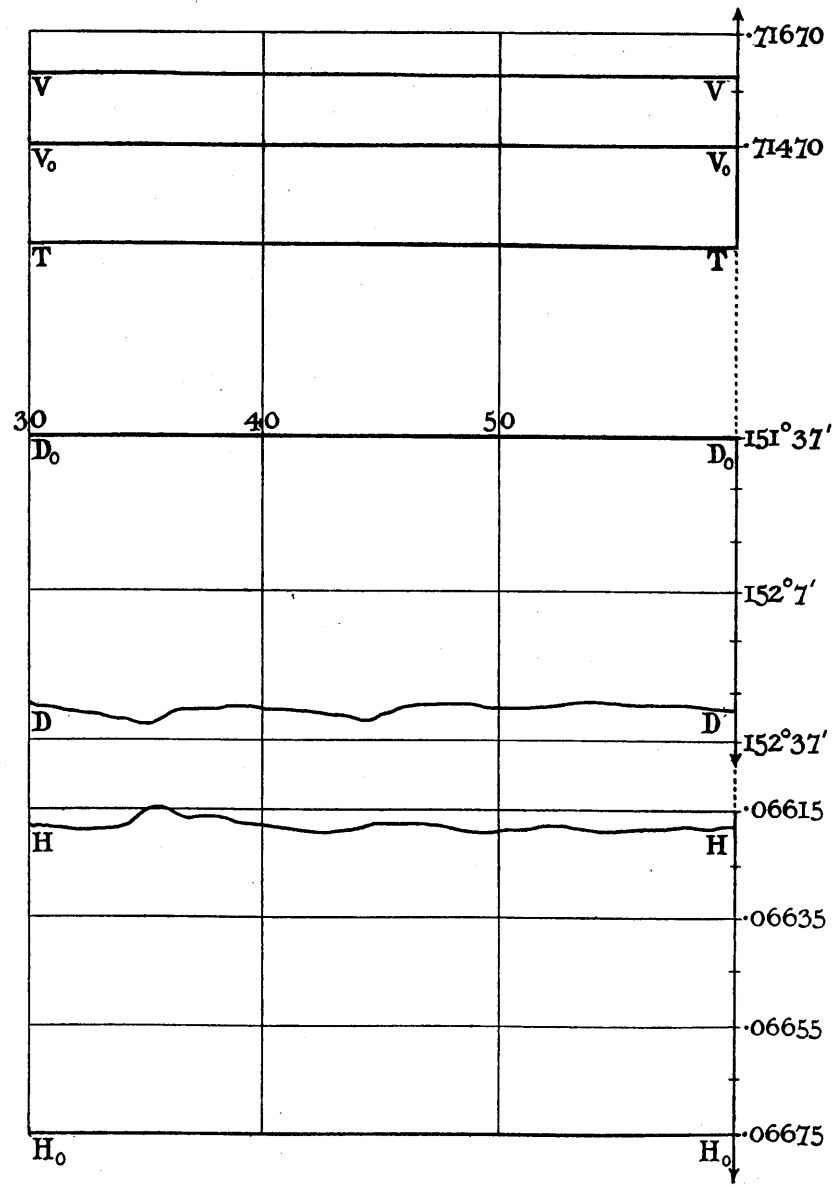
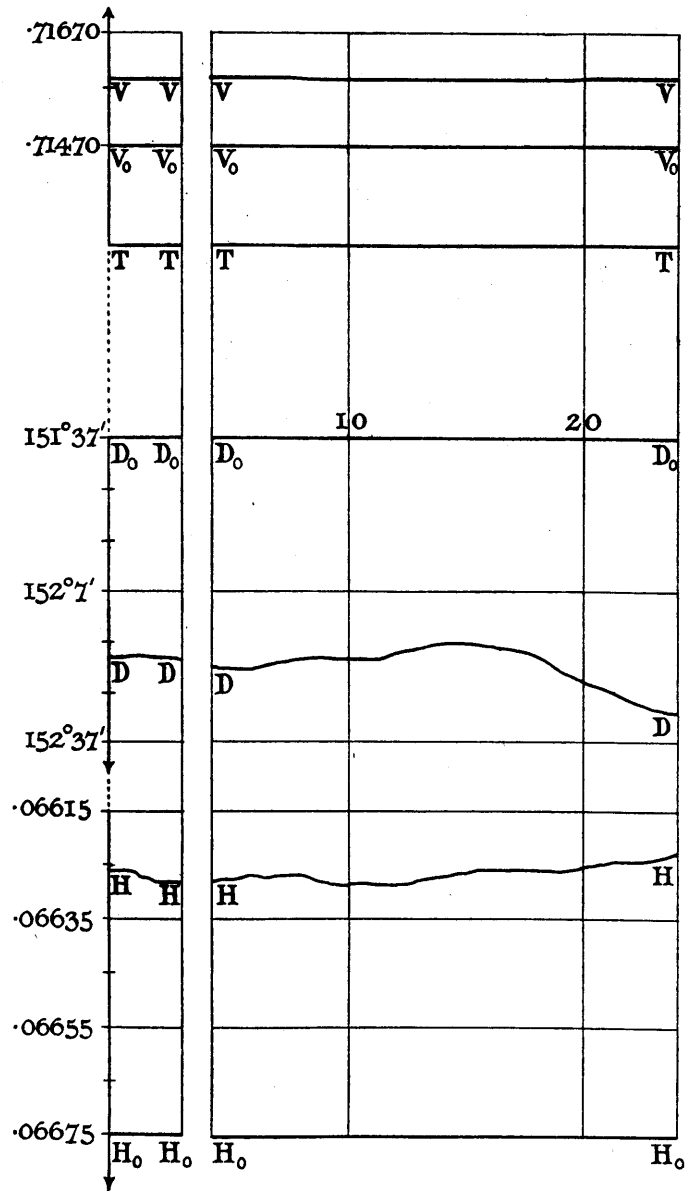

Term Hour, July 1, 1902, at Winter Quarters.



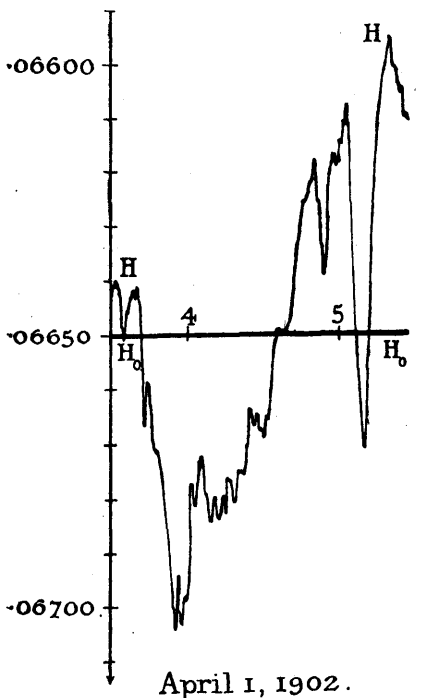
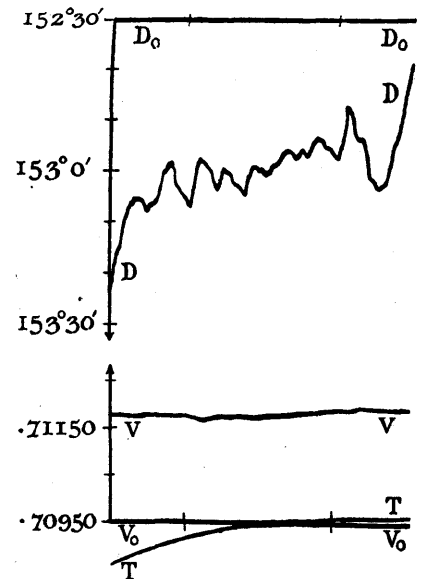

April 1, 1902.

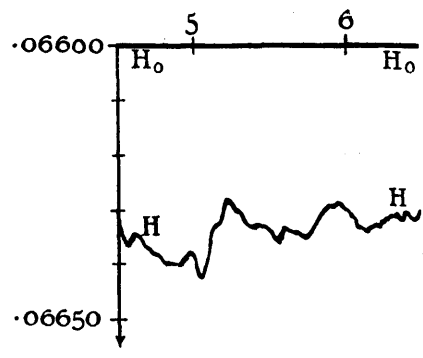
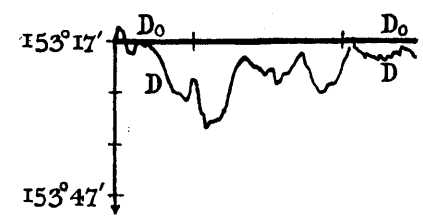
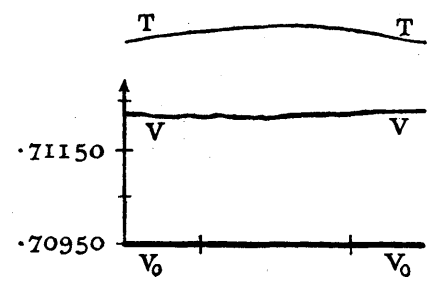

April 15, 1902.

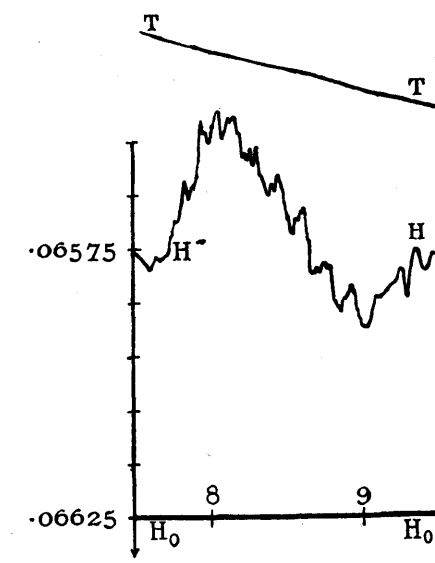
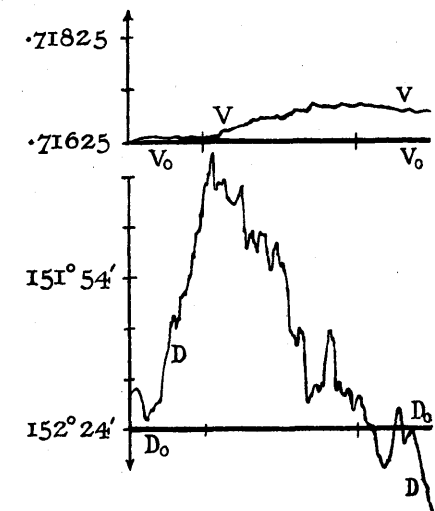

June 1, 1902.

Term Hours, April 1 and 15, and June 1, 1902, at Winter Quarters.





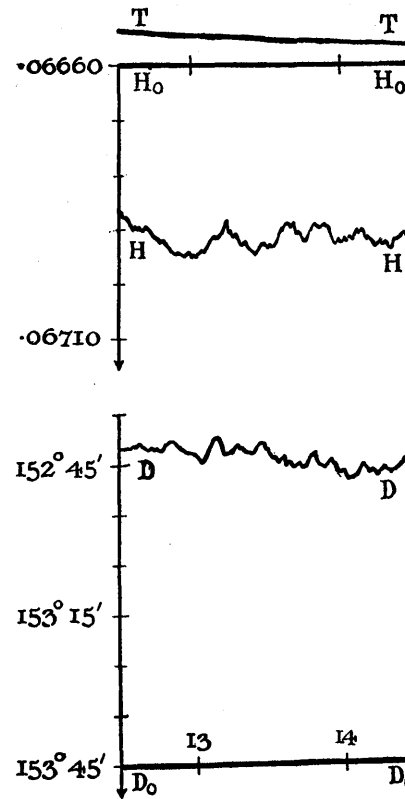
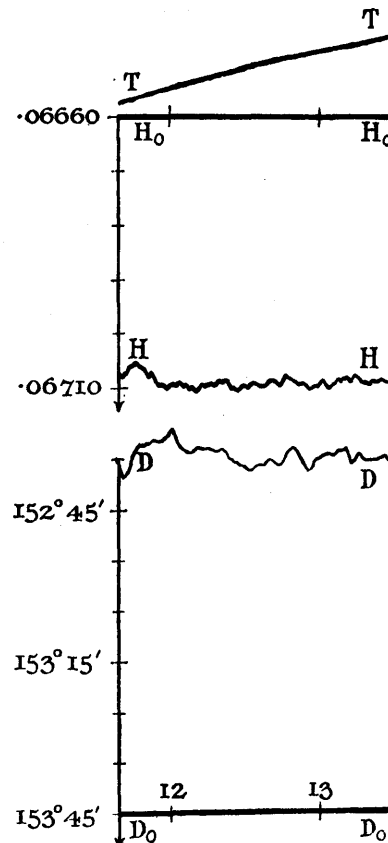
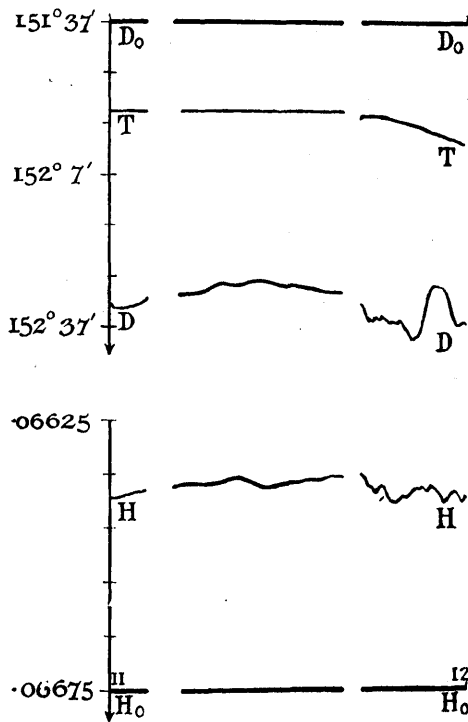
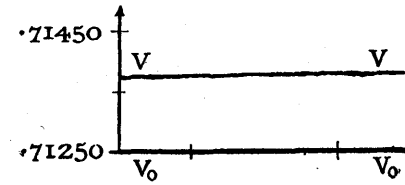
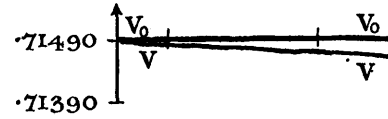
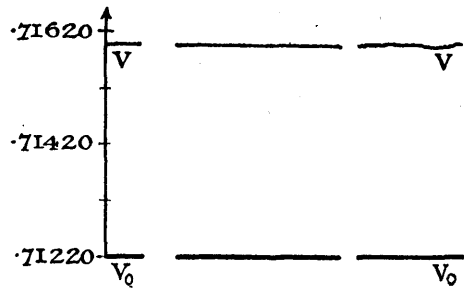

July 15, 1902.

August 1, 1902.

August 15, 1902.

Term Hours, July 15, and August 1 and 15, 1902, at Winter Quarters.

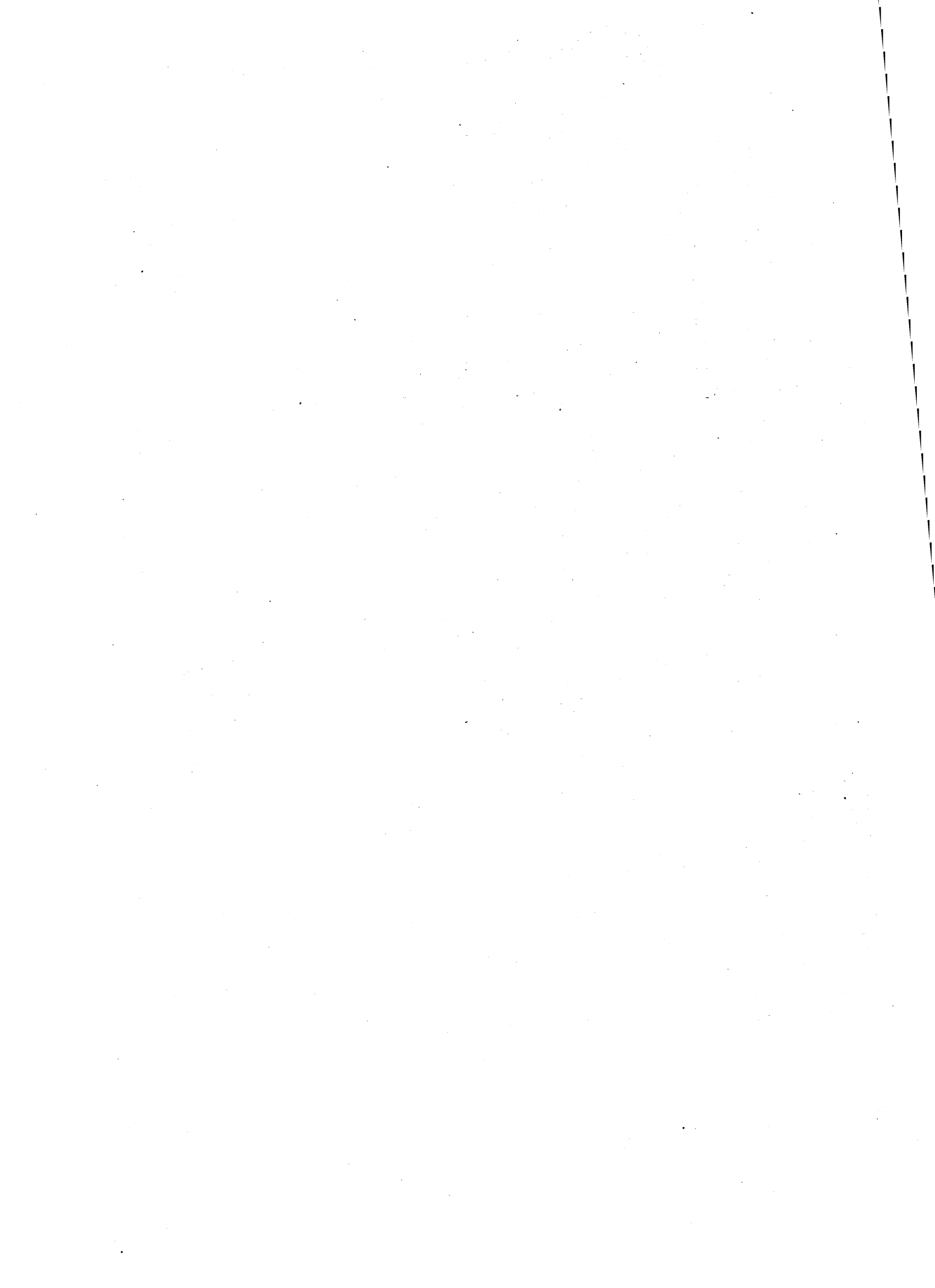

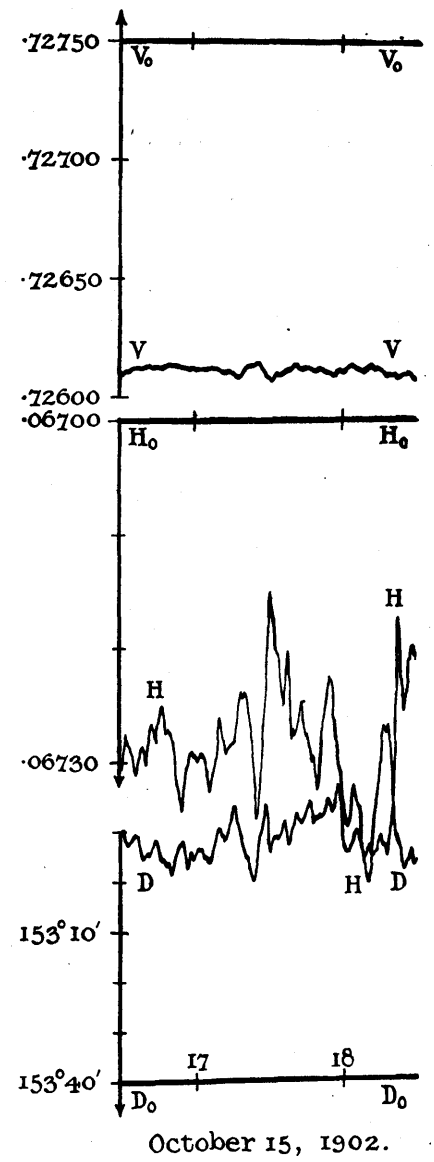
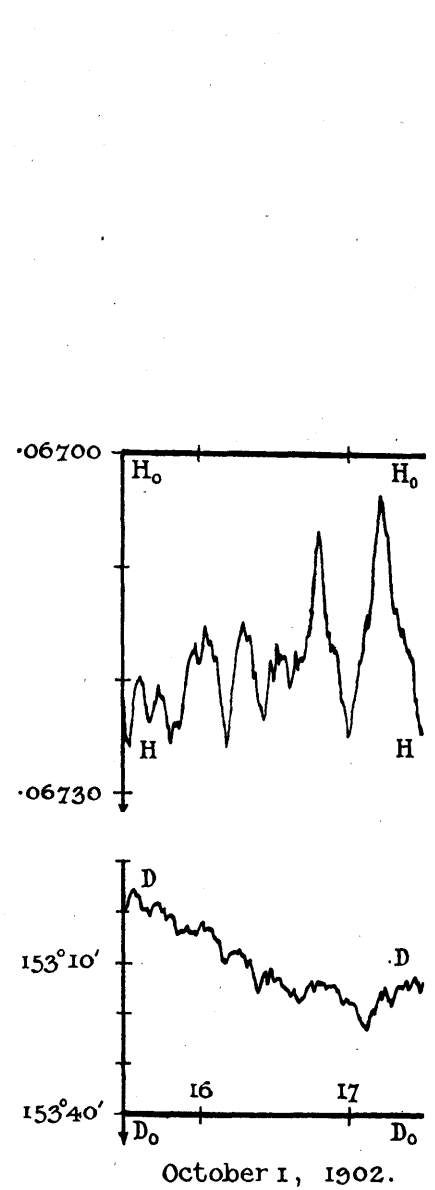
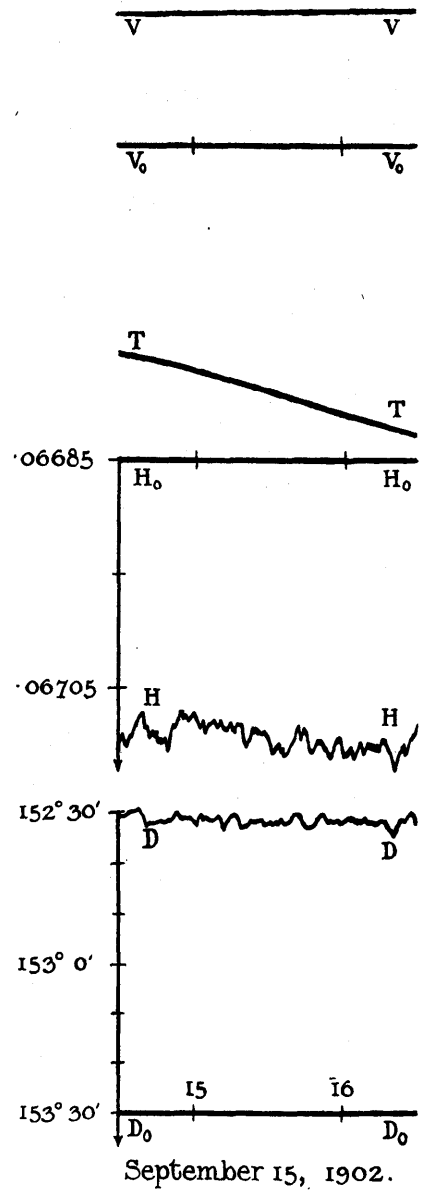
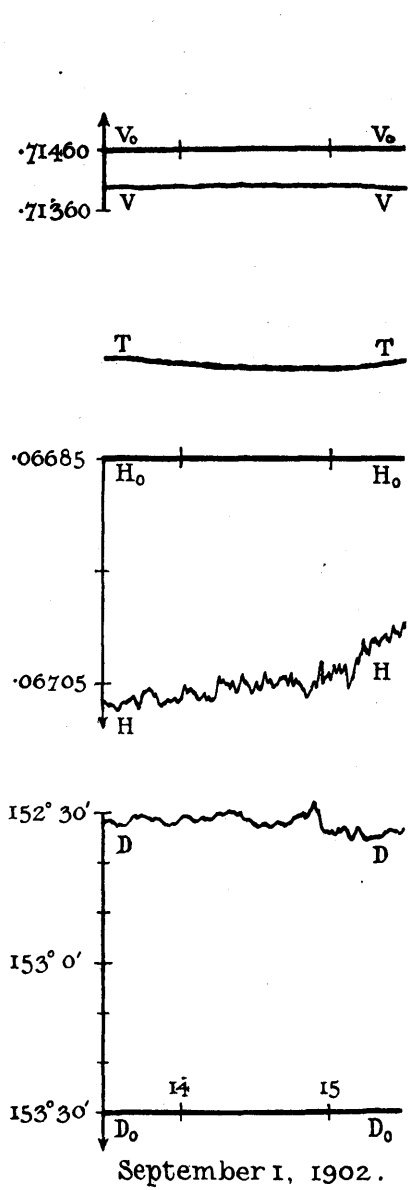

Term Hours, September 1 and 15, and October 1 and 15, 1902, at Winter Quarters.



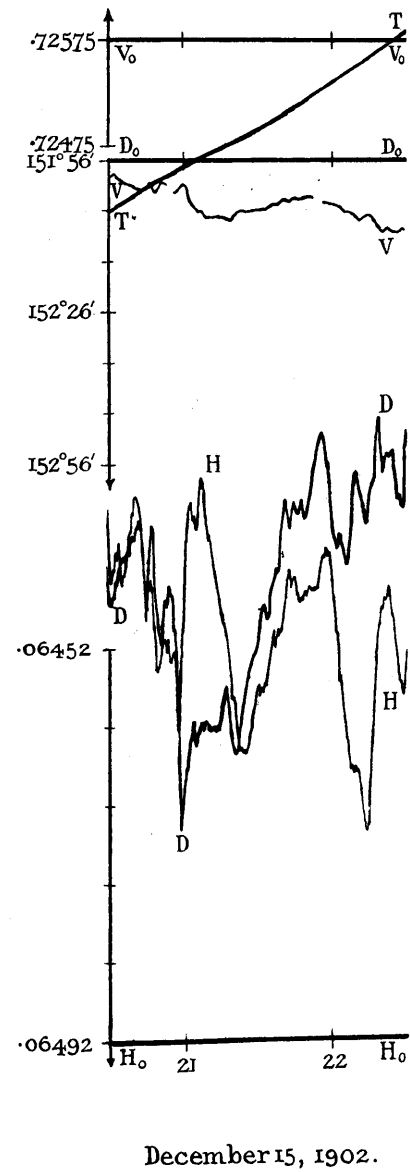
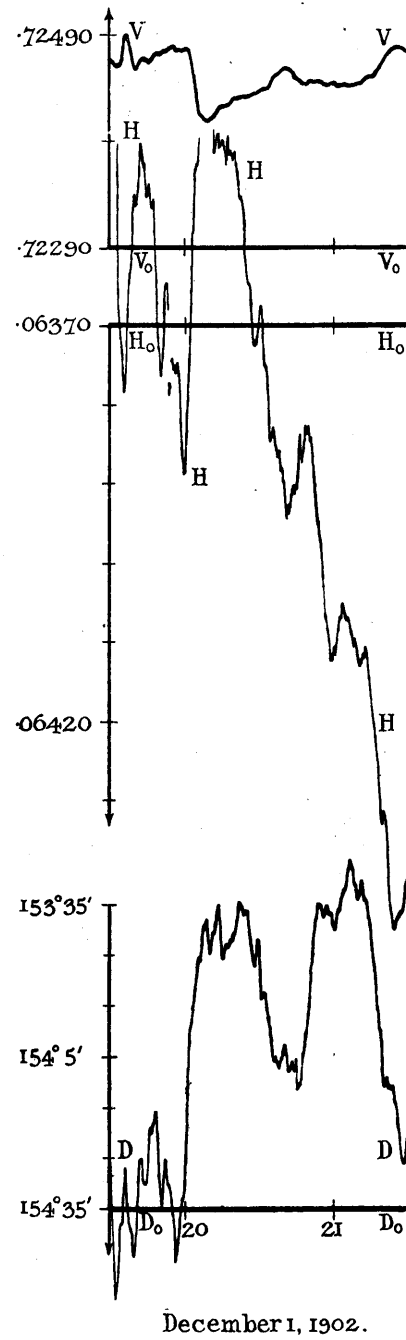
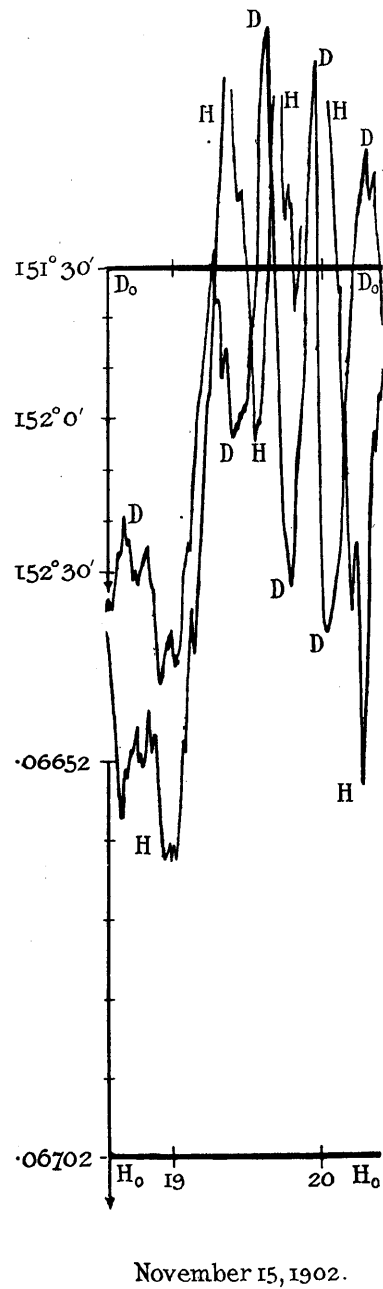
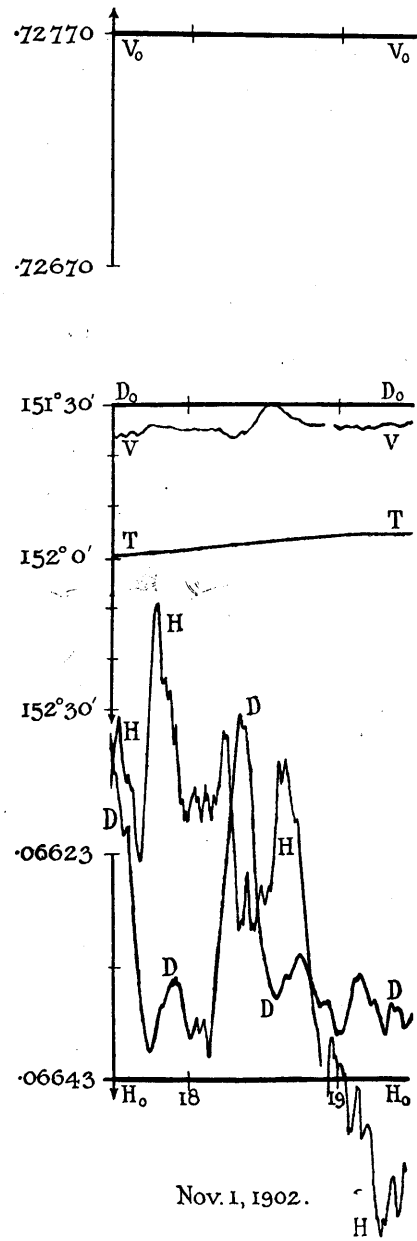

Term Hours, November 1 and 15, and December 1 and 15, 1902, at Winter Quarters.



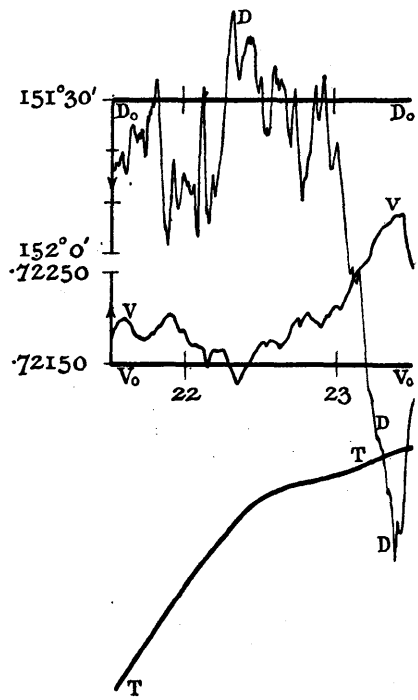

January 1, 1903.

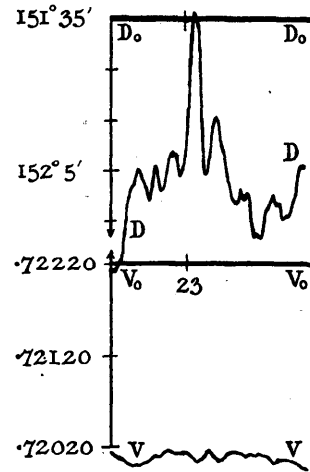

January 15, 1903.

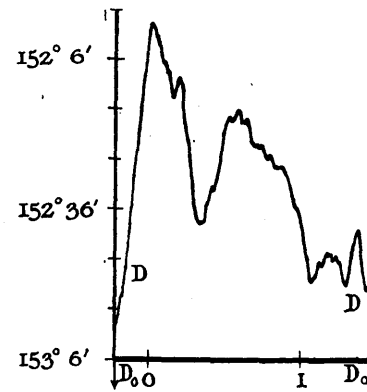
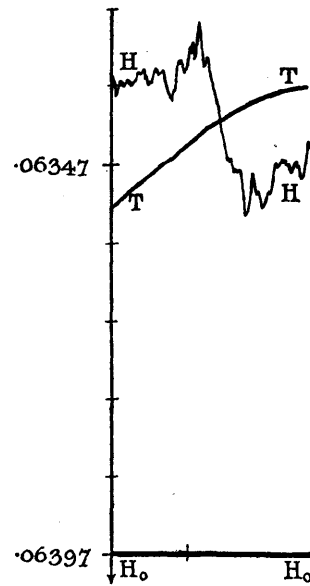

Feb. 1, 1903.

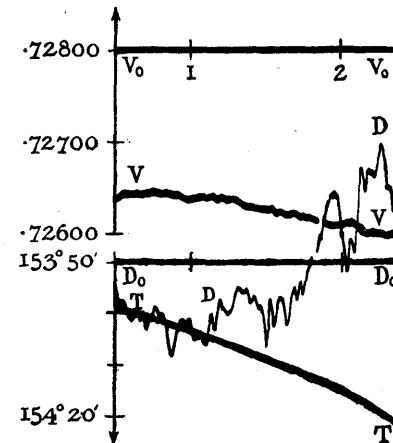
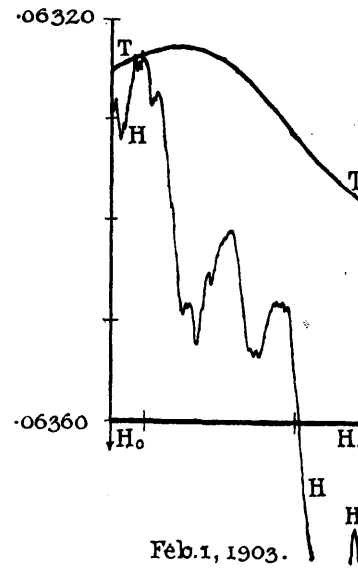

February 15, 1903.

Term Hours, January 1 and 15, and February 1 and 15, 1903, at Winter Quarters.



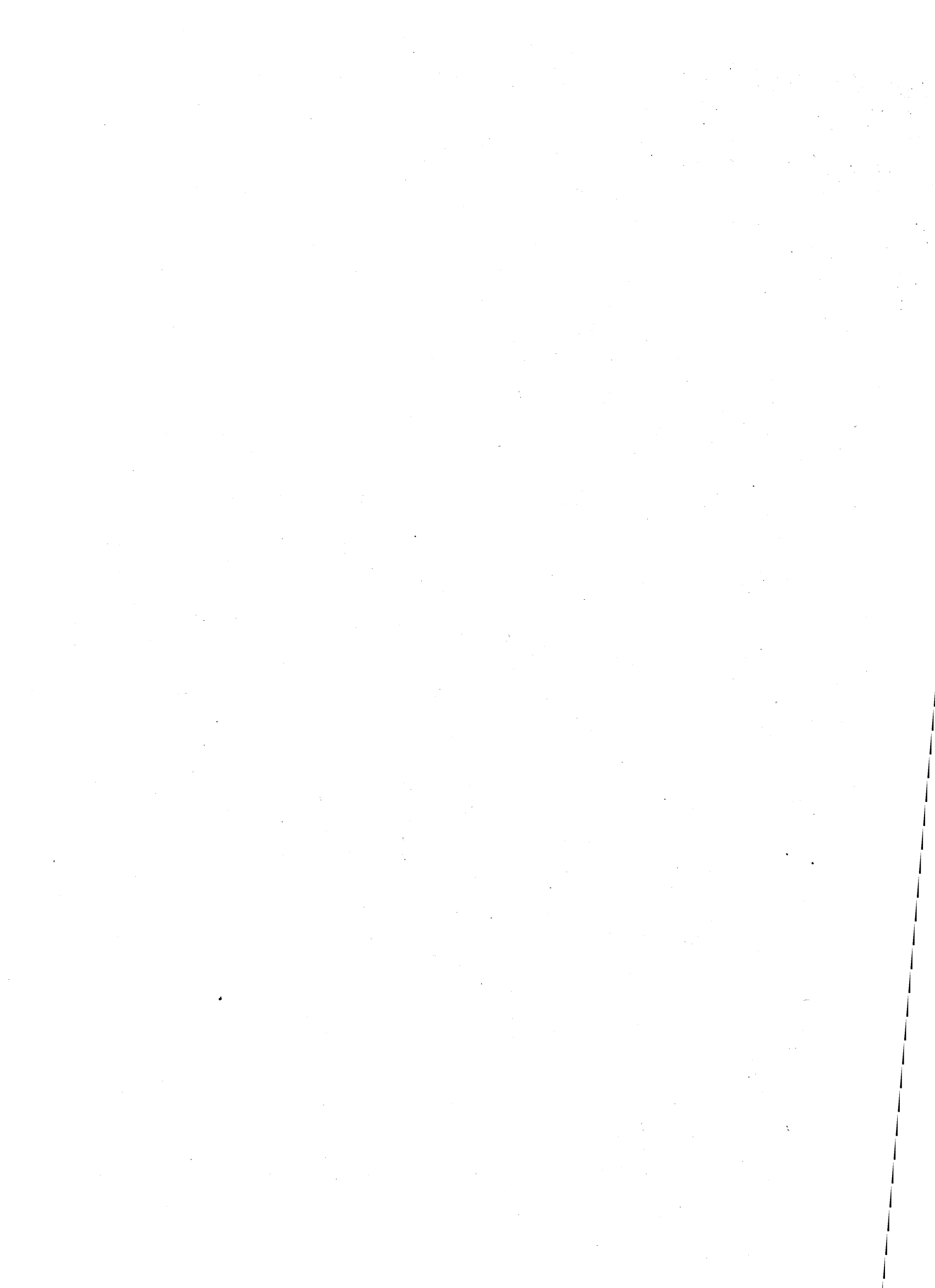

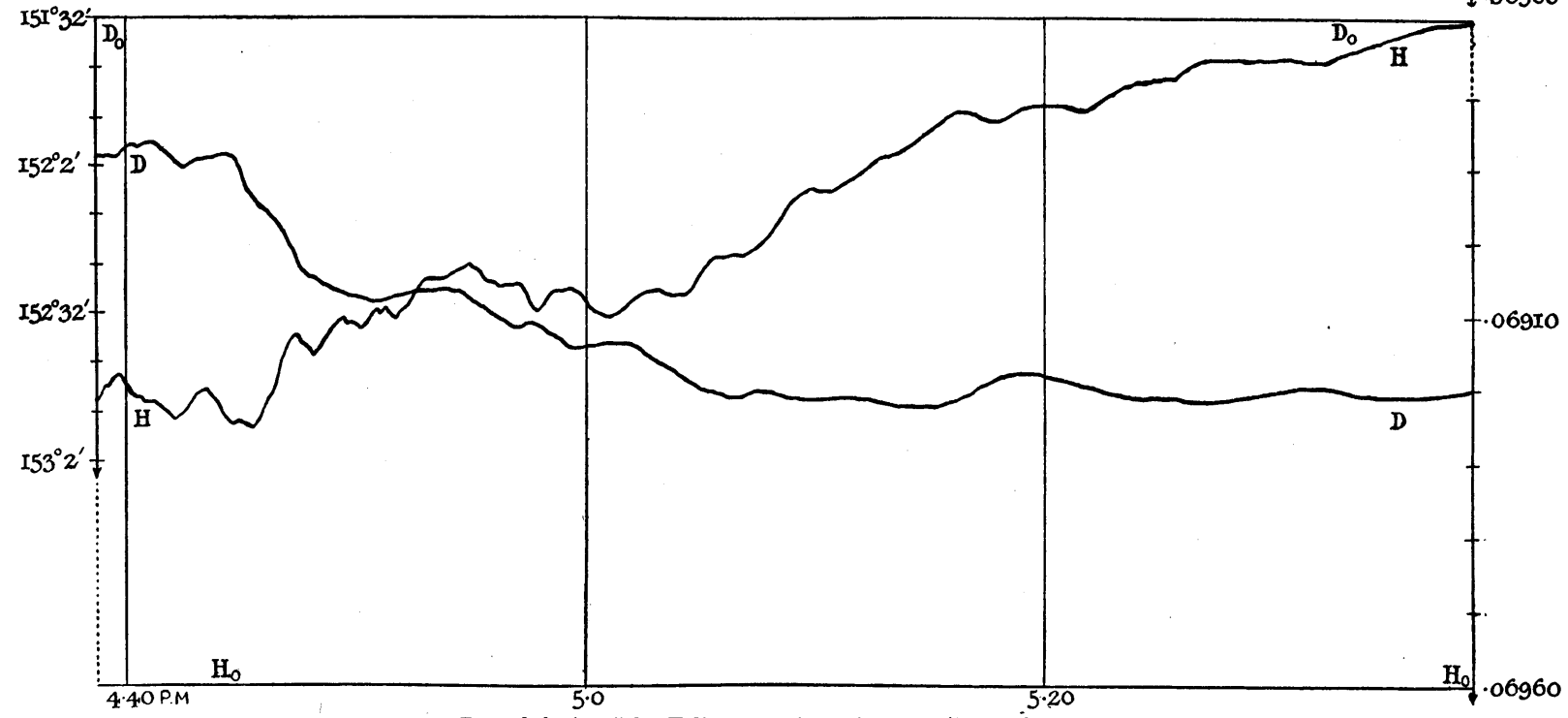
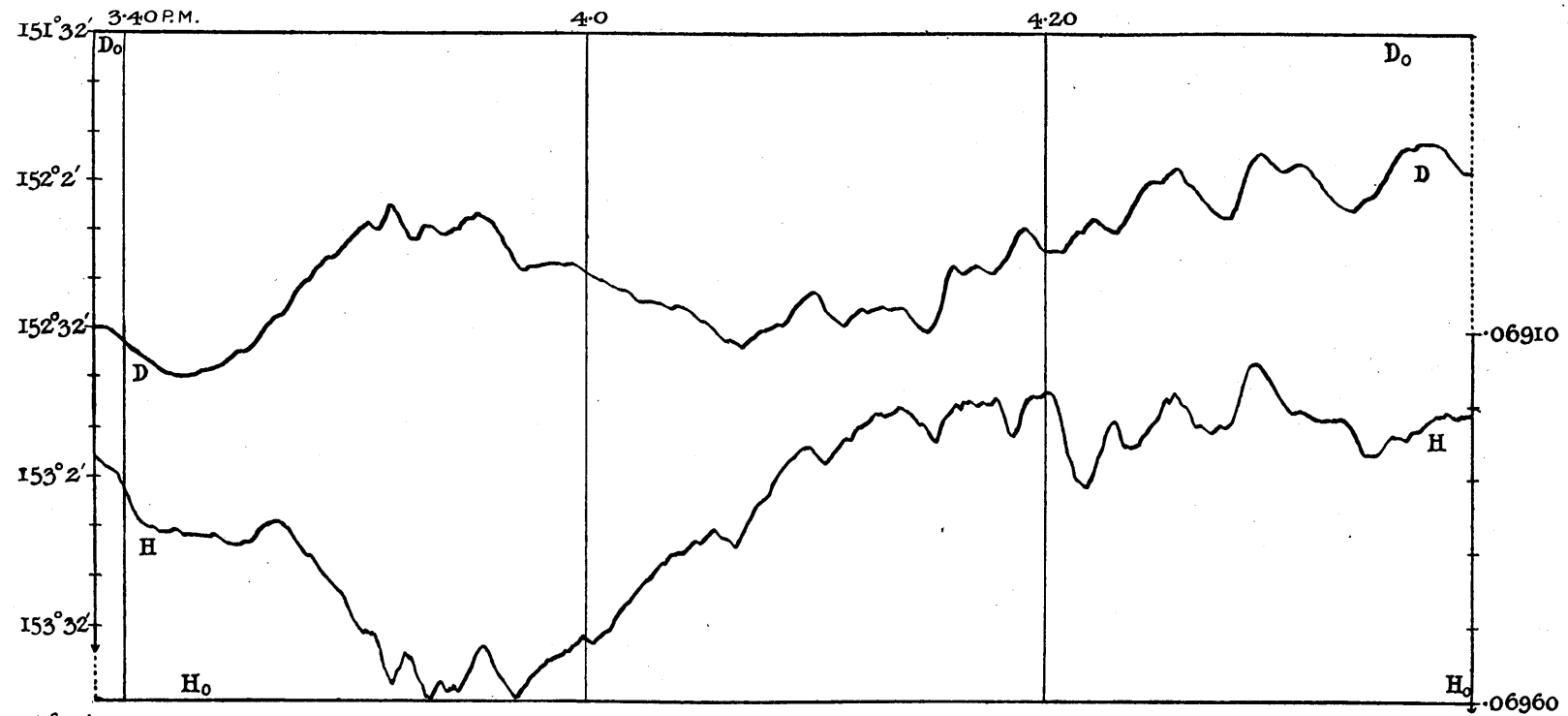

Record during Solar Eclipse at Winter Quarters (September 21, 1903).



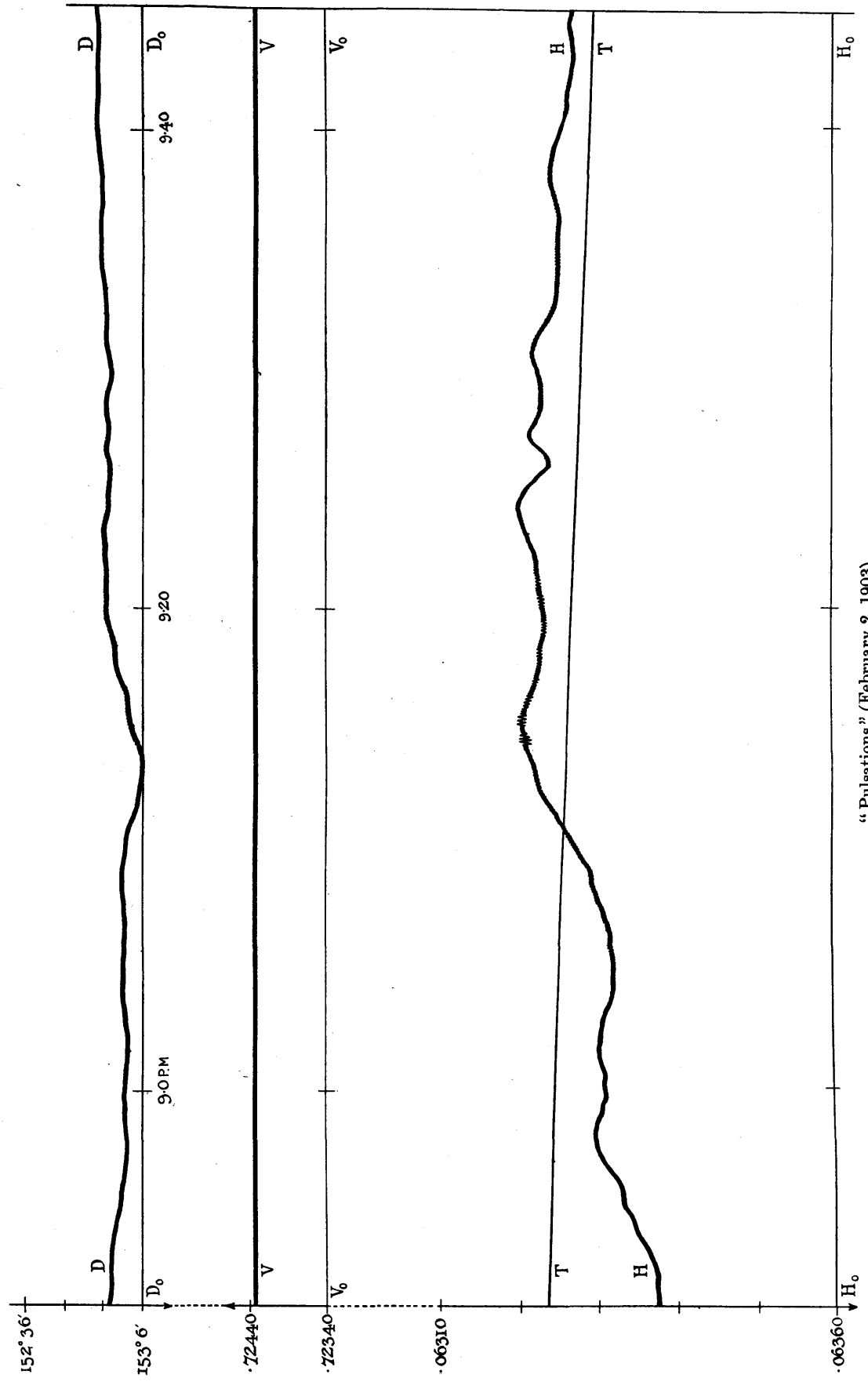

"Pulsations" (February 2, 1903).



June 27-28, 1903.

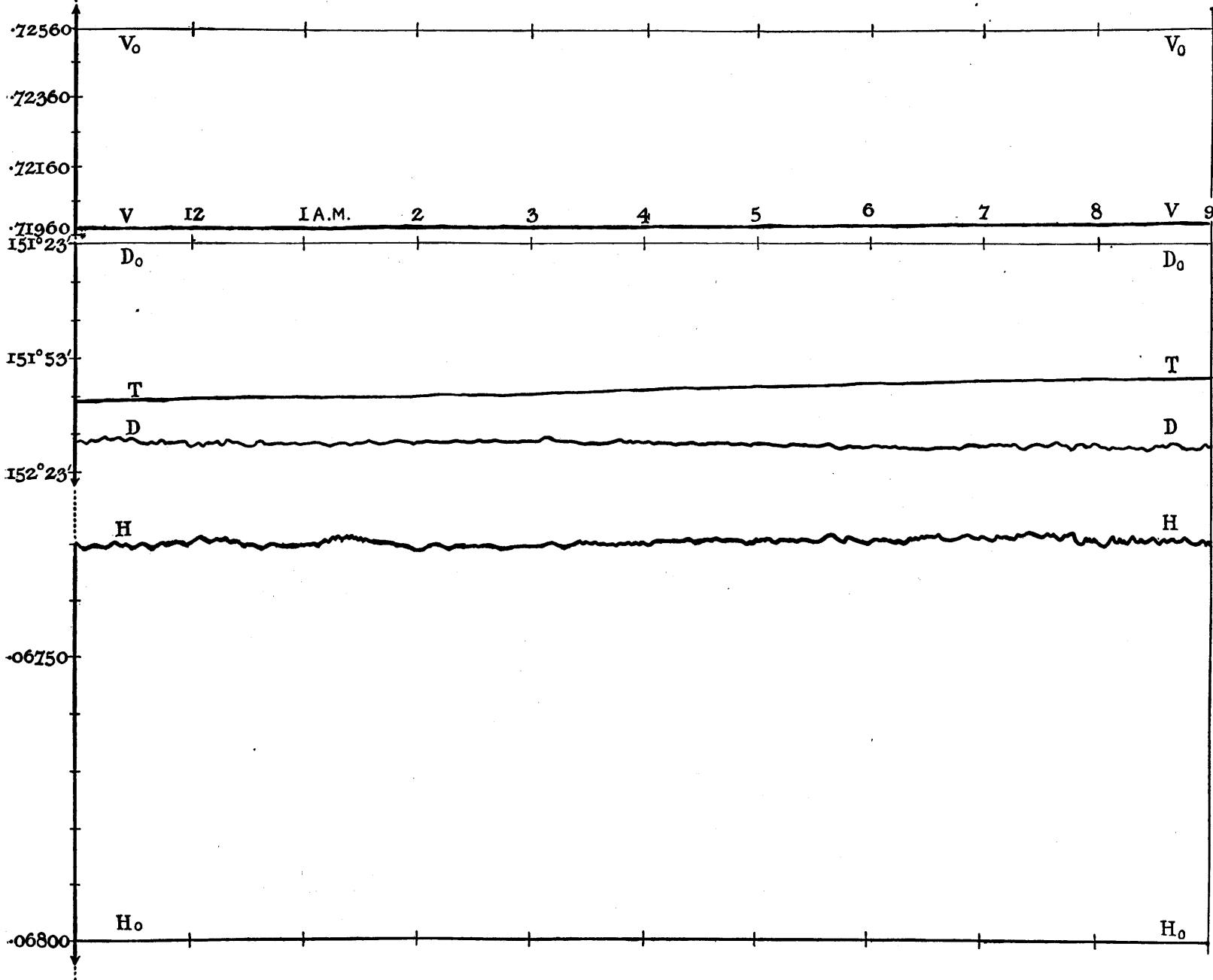

Record during especially Quiet Day (June 27 and 28, 1903).

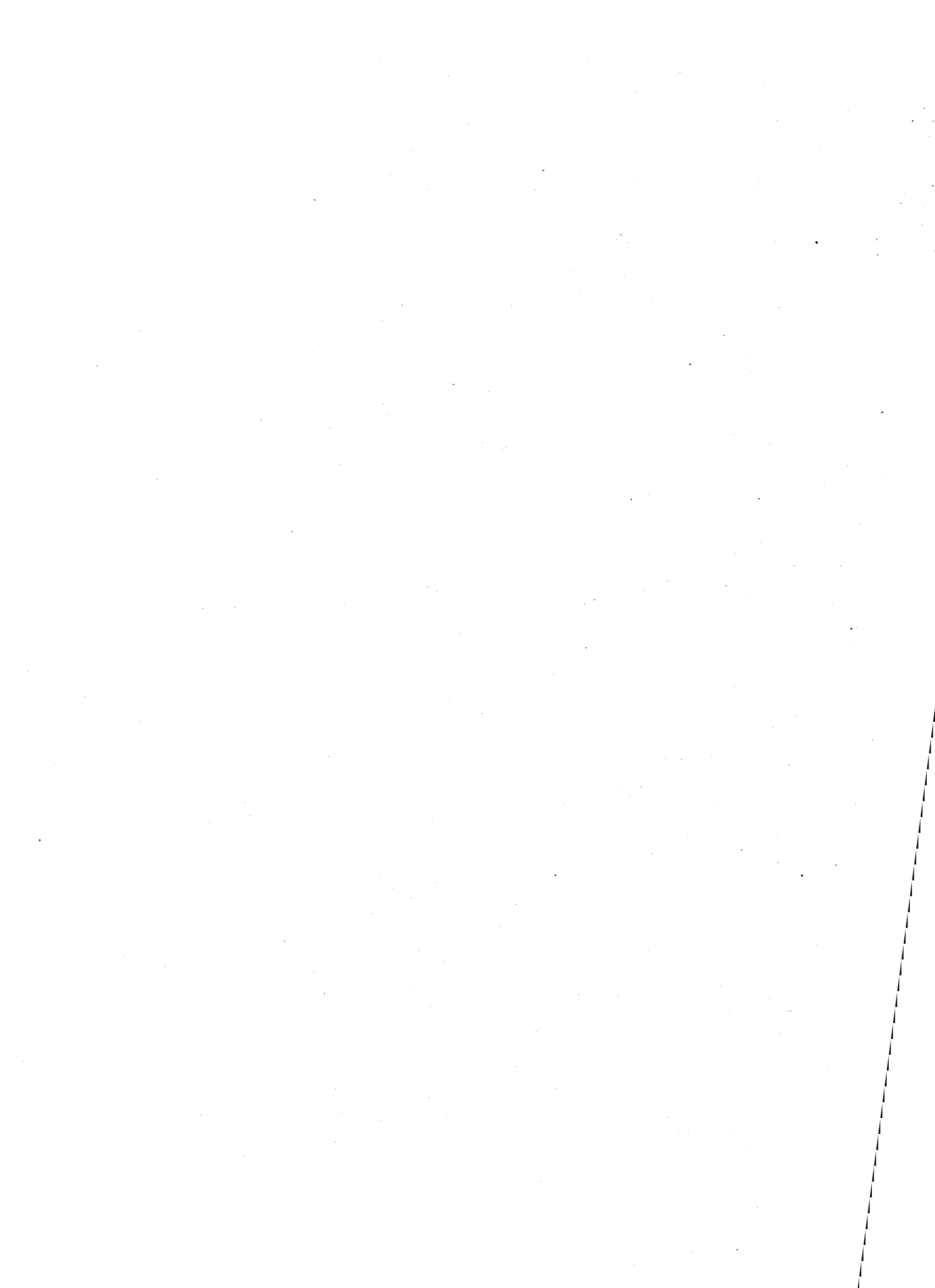

May 8, 1902.

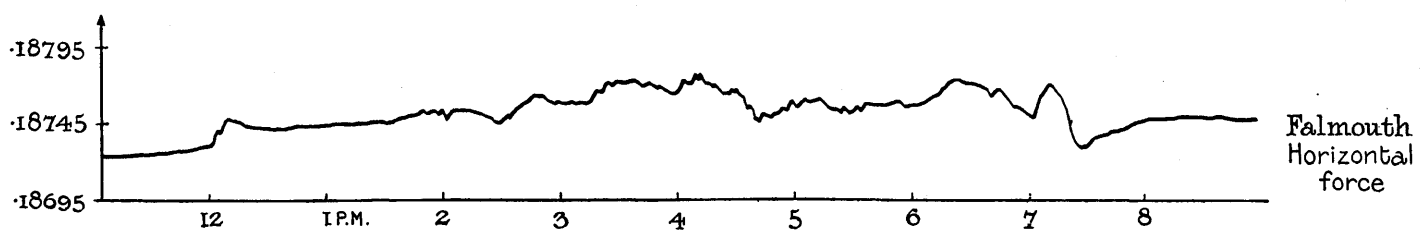
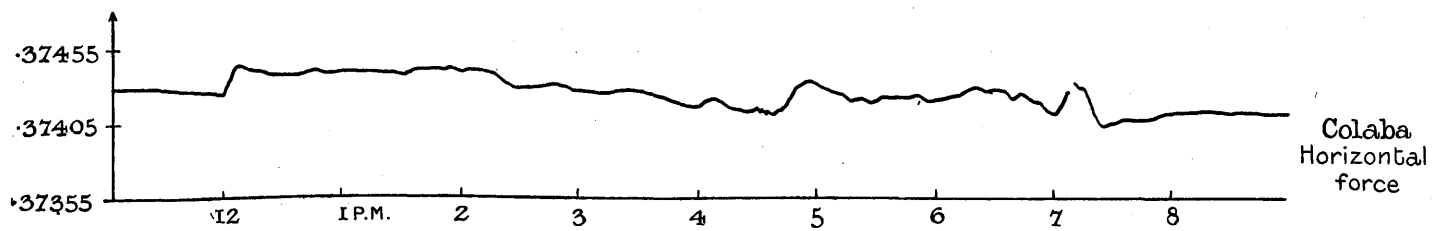
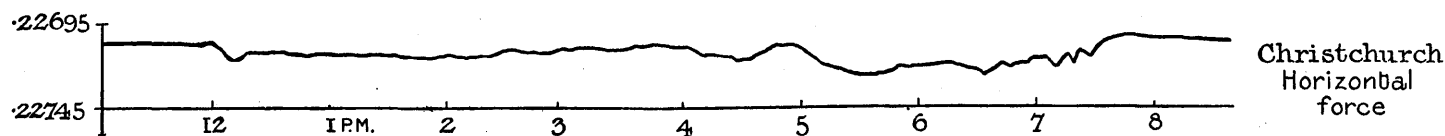
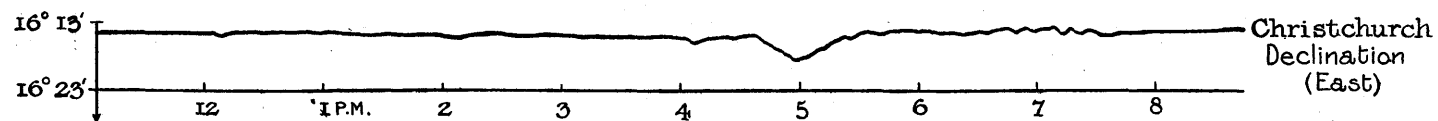

Disturbance of May 8, 1902, at Co-operating Stations.





Horizontal force August 20, 1902.

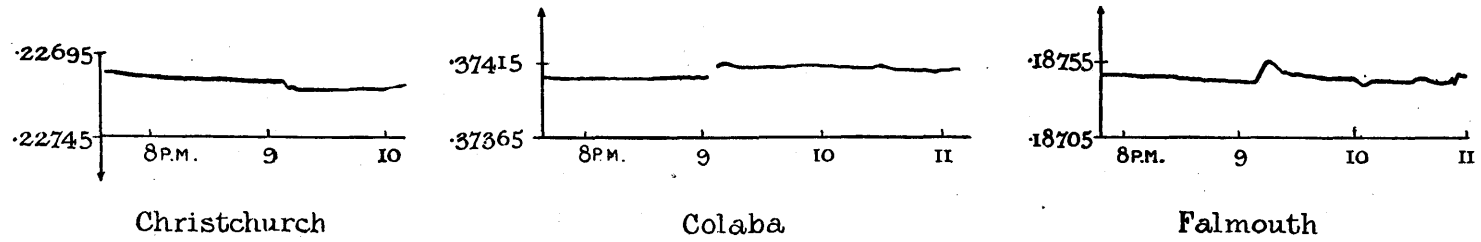

November 6  
1902

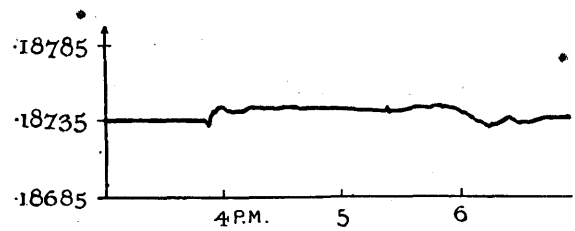

Falmouth  
Horizontal force

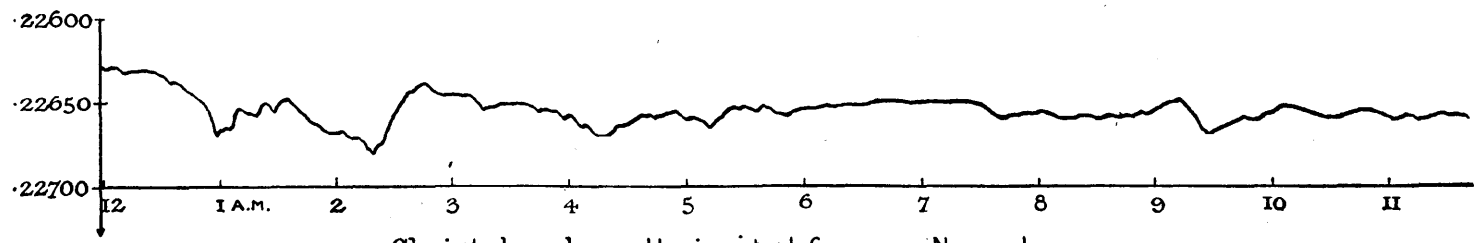

Christchurch Horizontal force November 24, 1902.

Disturbance of August 20, and November 6 and 24, 1902, at Co-operating Stations.



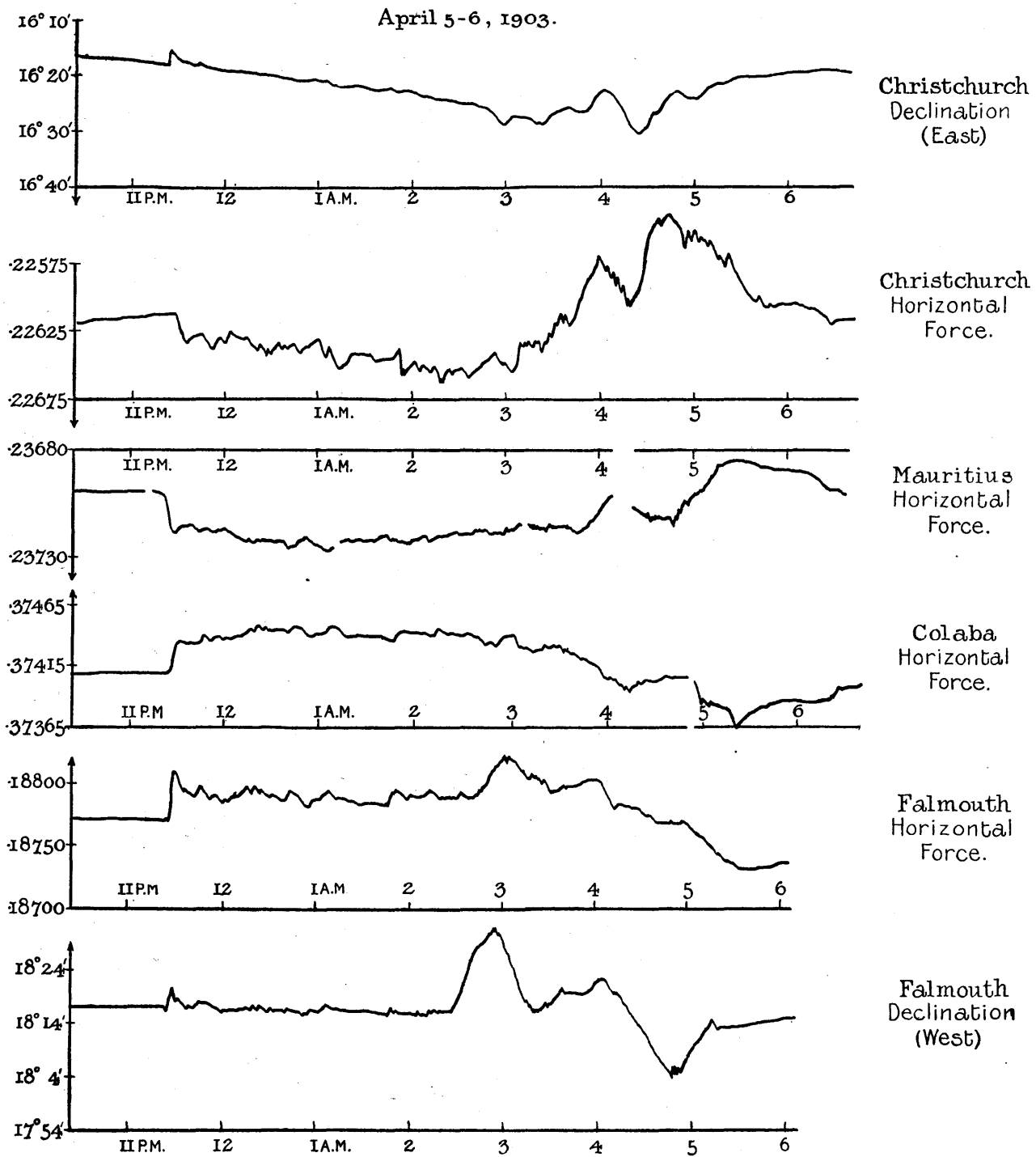

Disturbance of April 5 and 6, 1903, at Co-operating Stations.



Christchurch

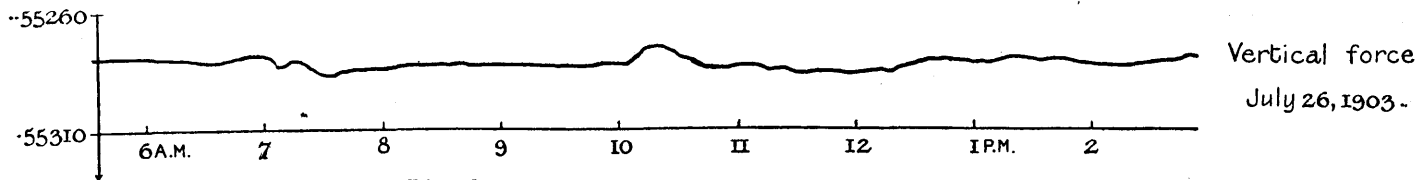
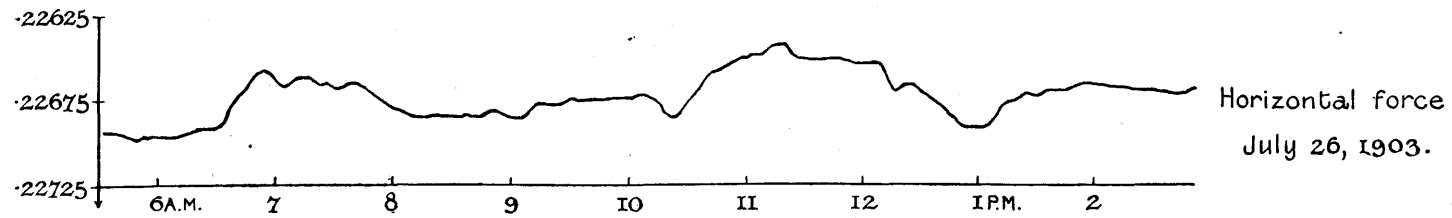
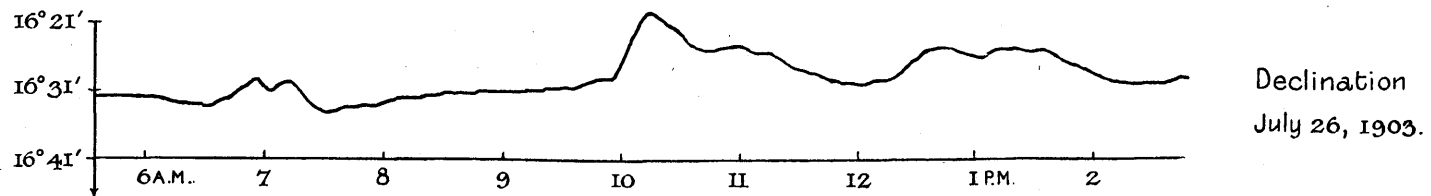
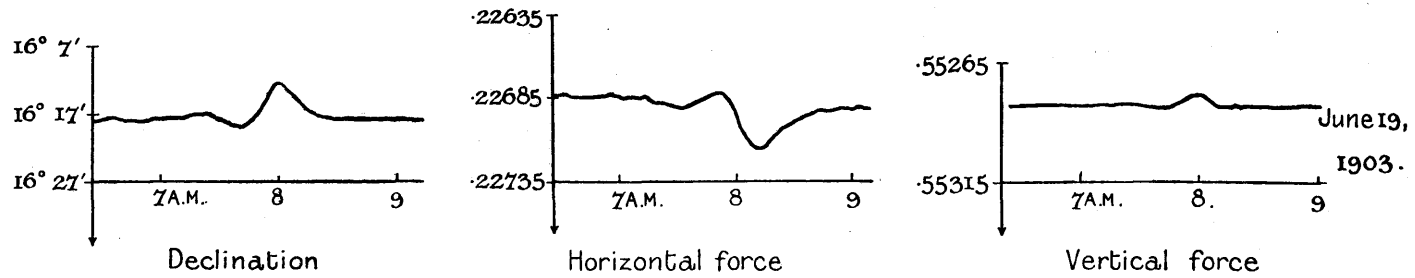

Disturbance of June 19, and July 26, 1903, at Christchurch.



Christchurch . August 22, 1903.

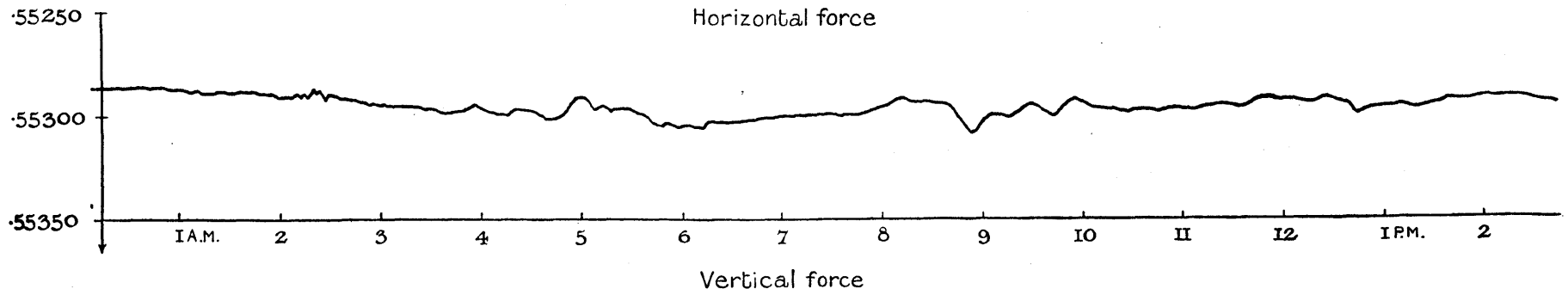
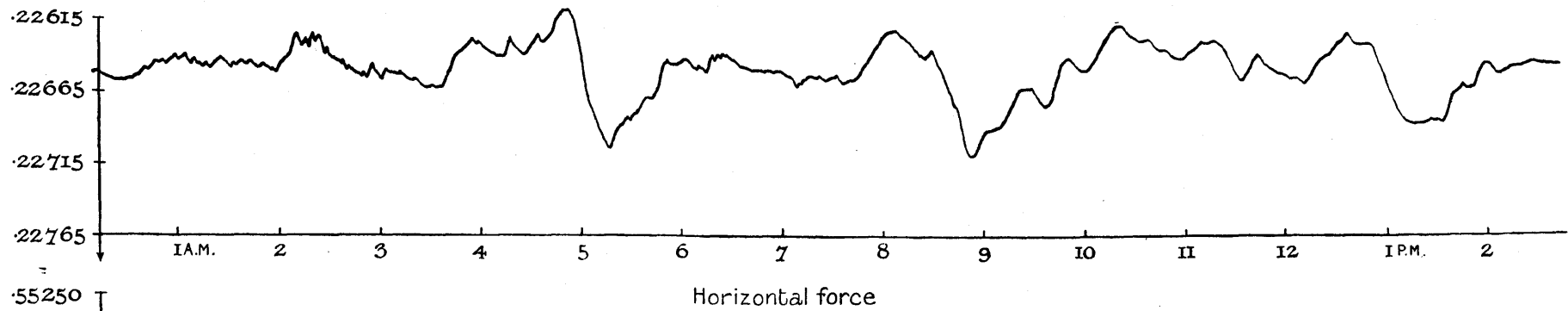
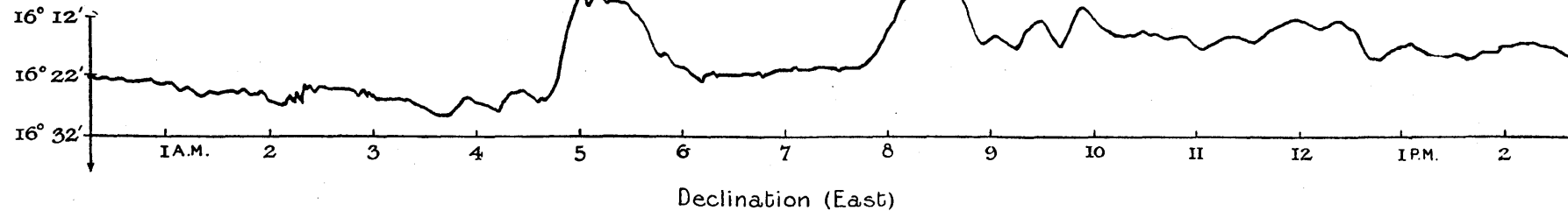

Disturbance of August 22, 1903, at Christchurch.





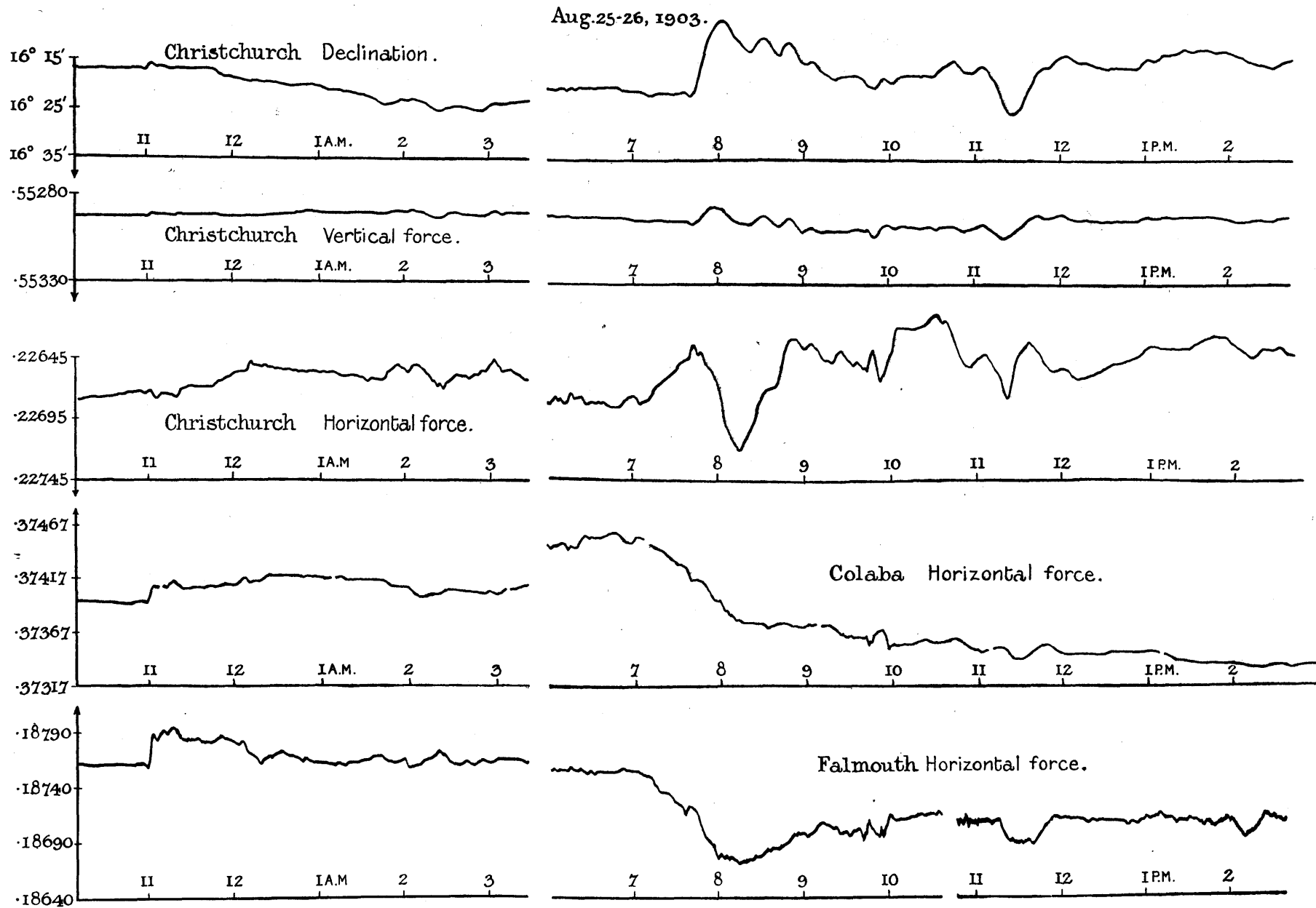

Disturbance of August 25 and 26, 1903, at Co-operating Stations.



Falmouth December 13, 1903.

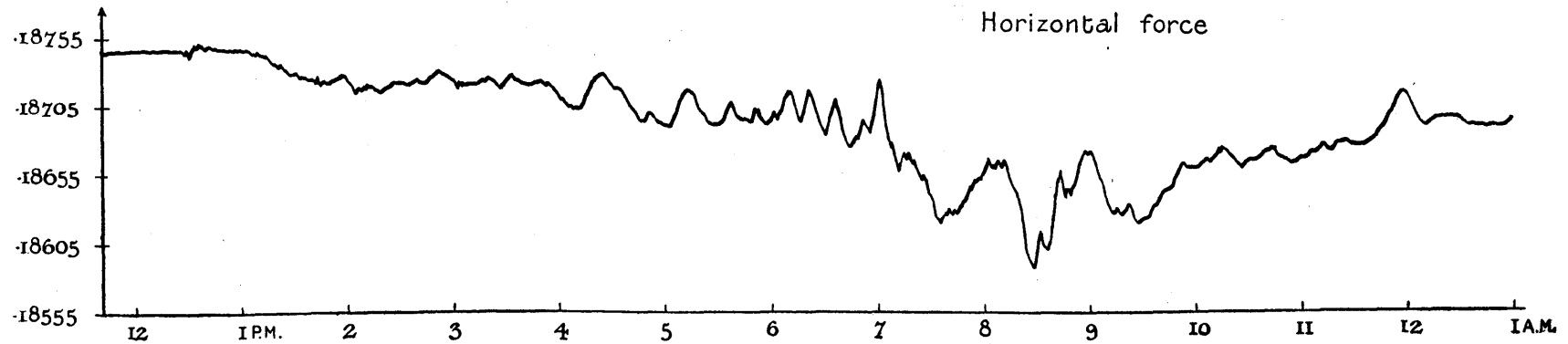
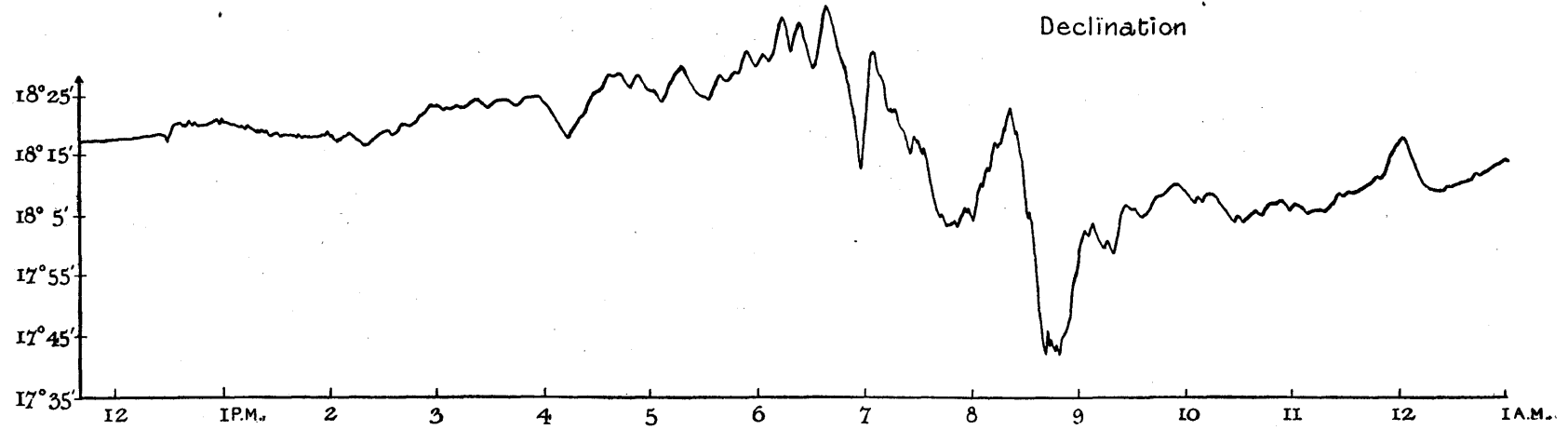

Disturbance of December 13, 1903, at Falmouth.



Horizontal force December 13, 1903.

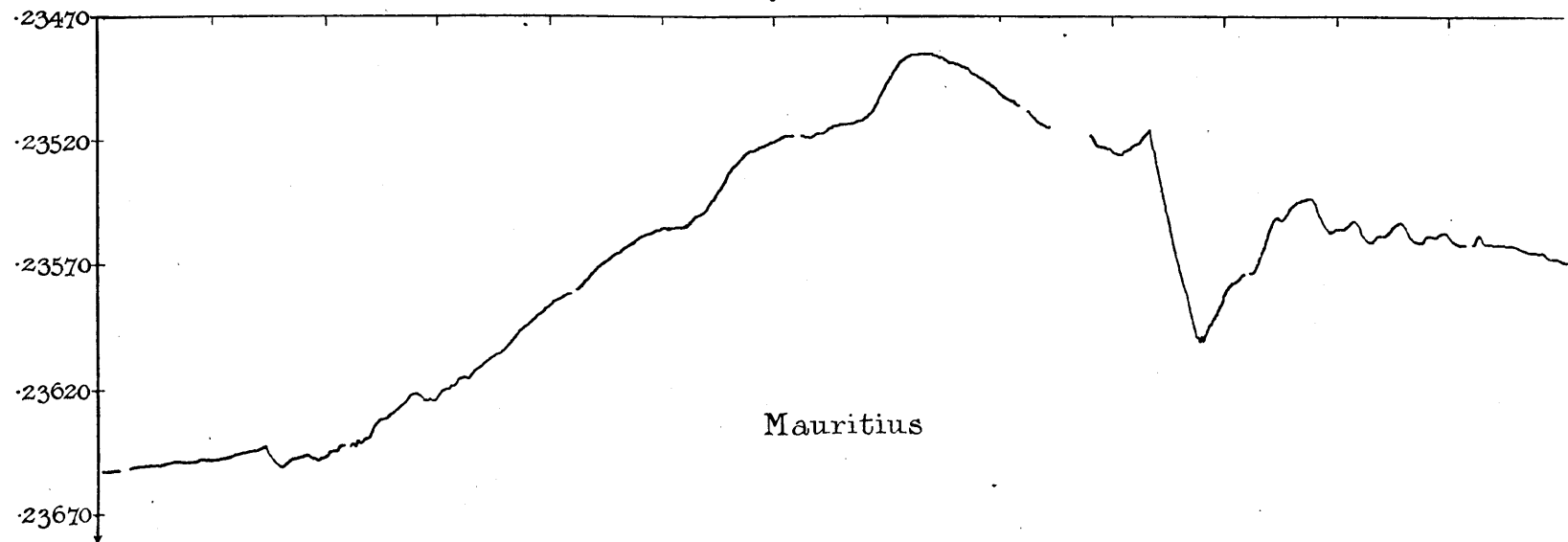
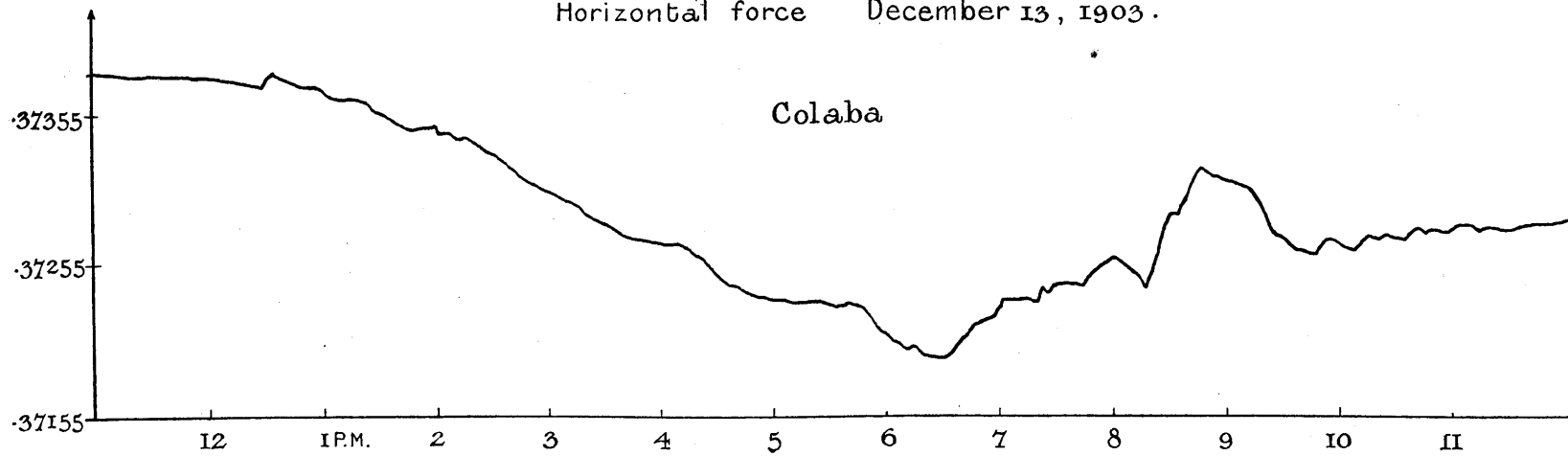

Disturbance of December 13, 1903, at Colaba and Mauritius.



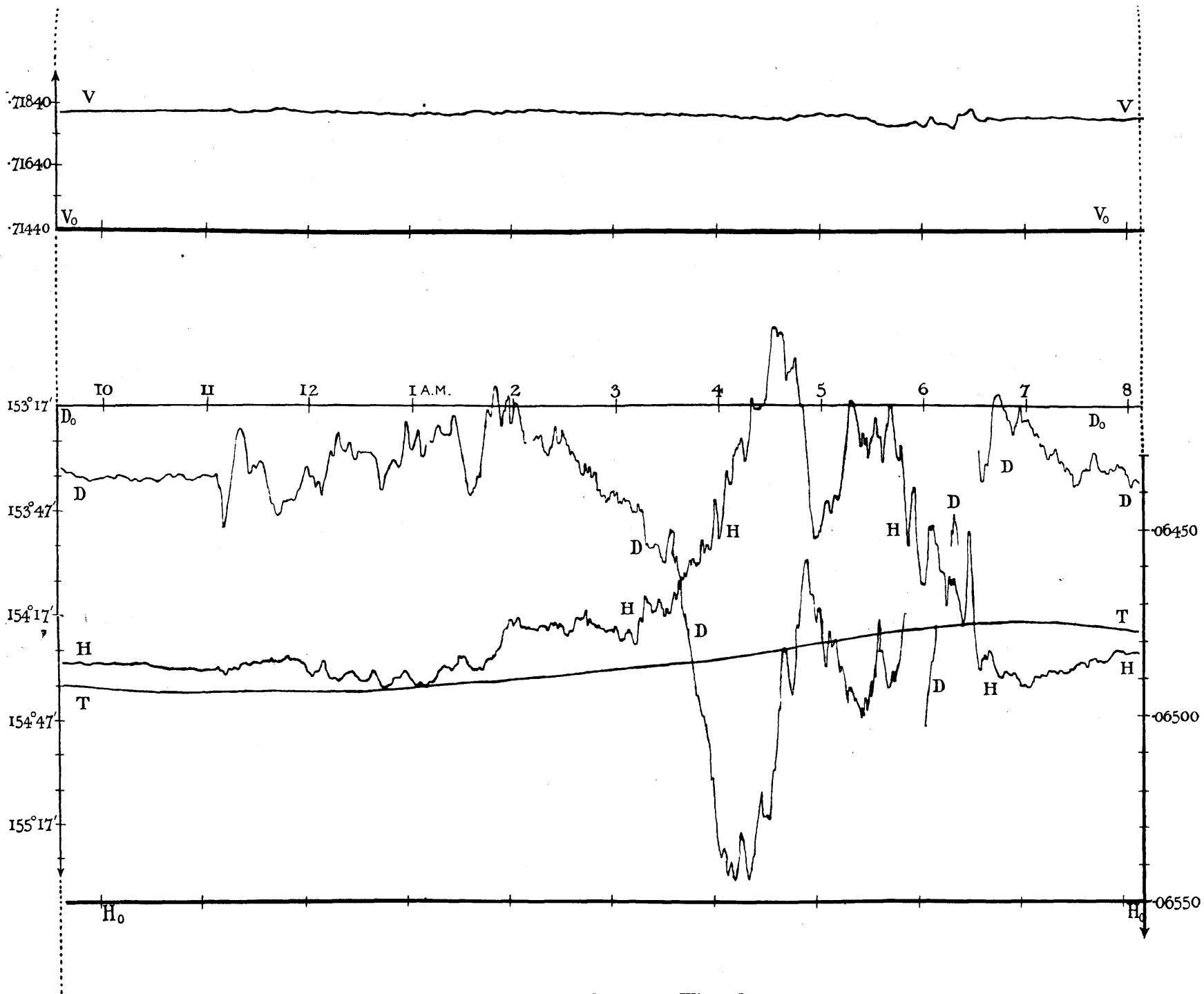

Disturbance of May 8 and 9, 1902, at Winter Quarters.



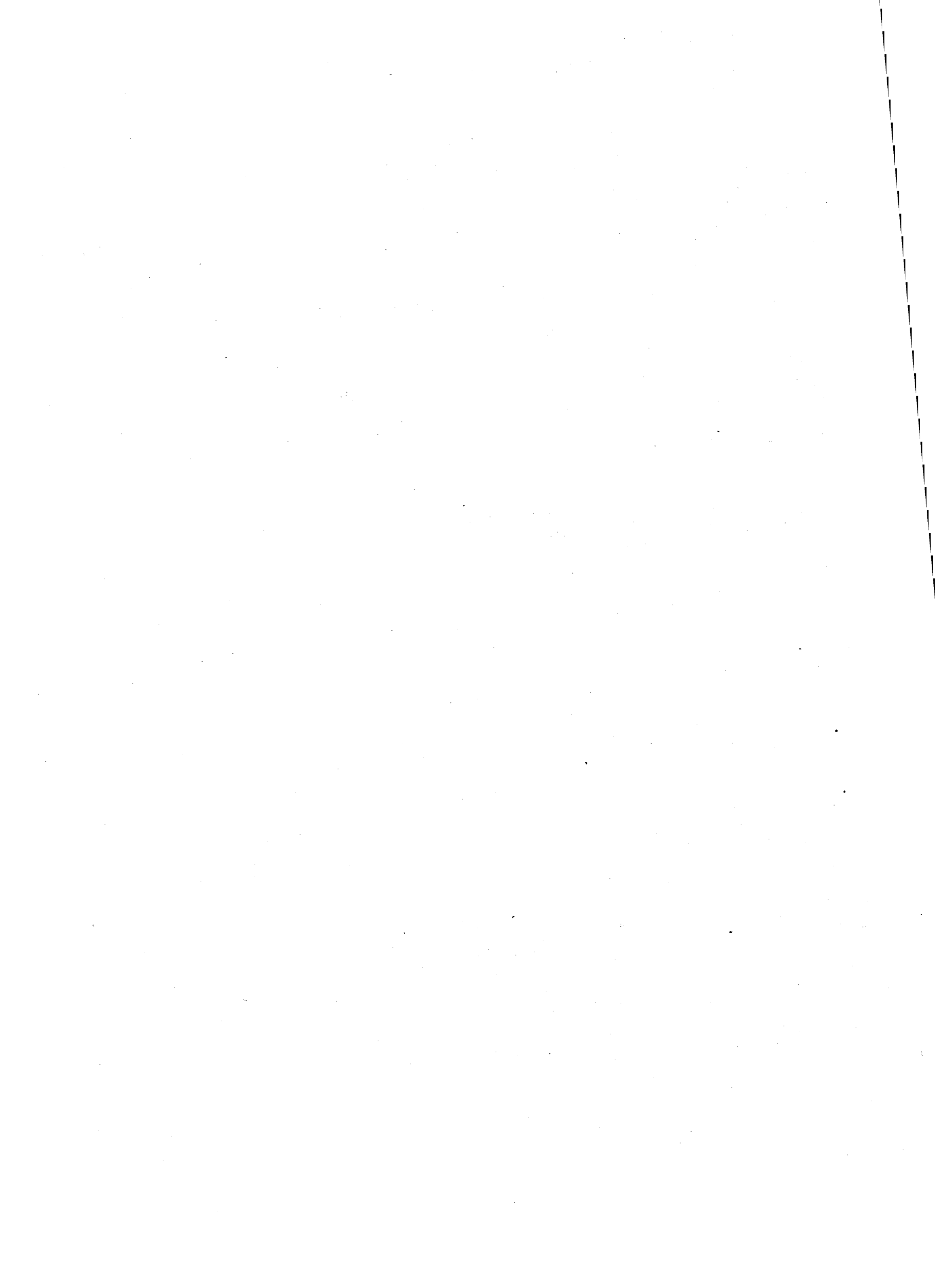

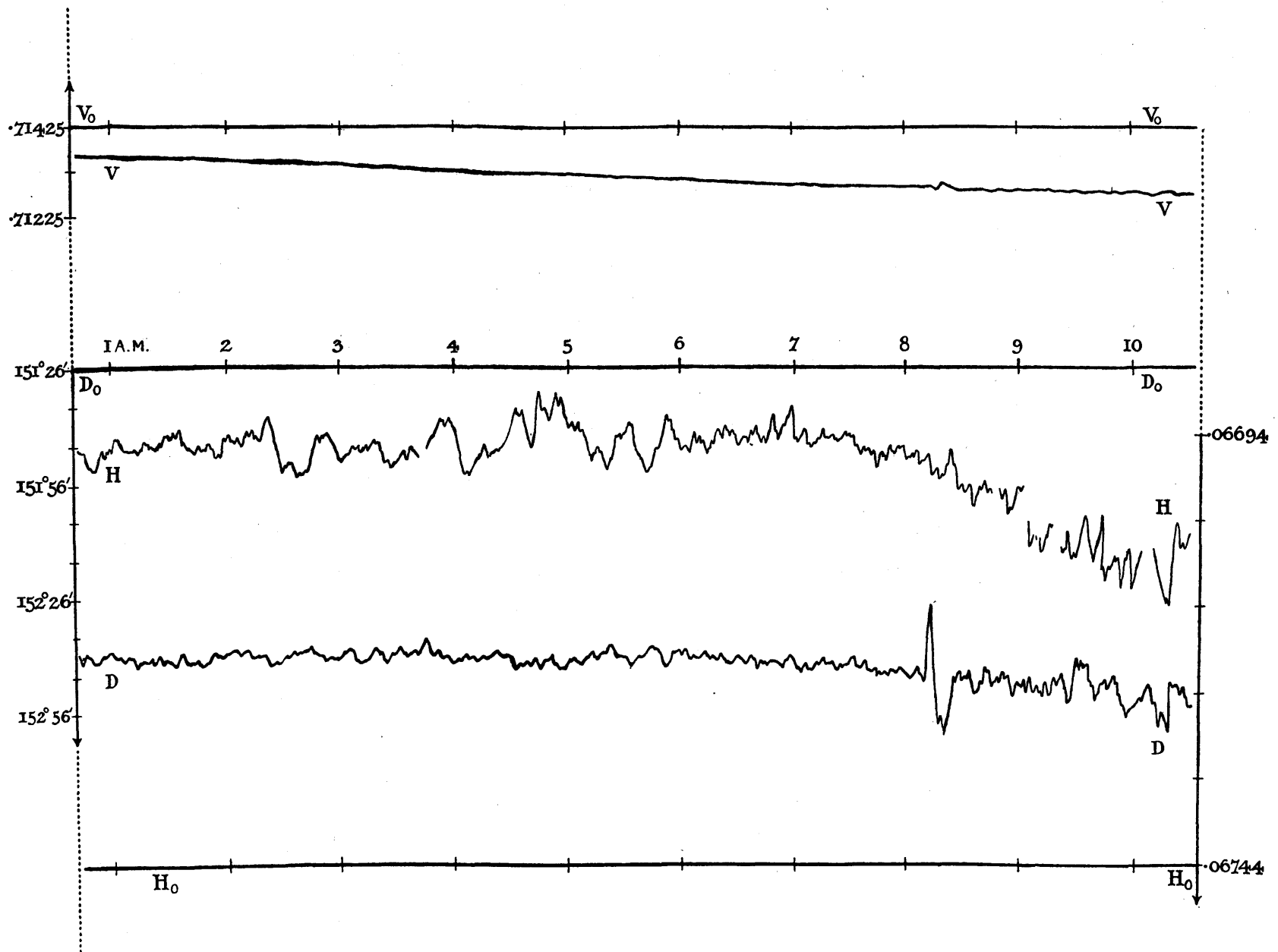

Disturbance of August 21, 1902, at Winter Quarters.

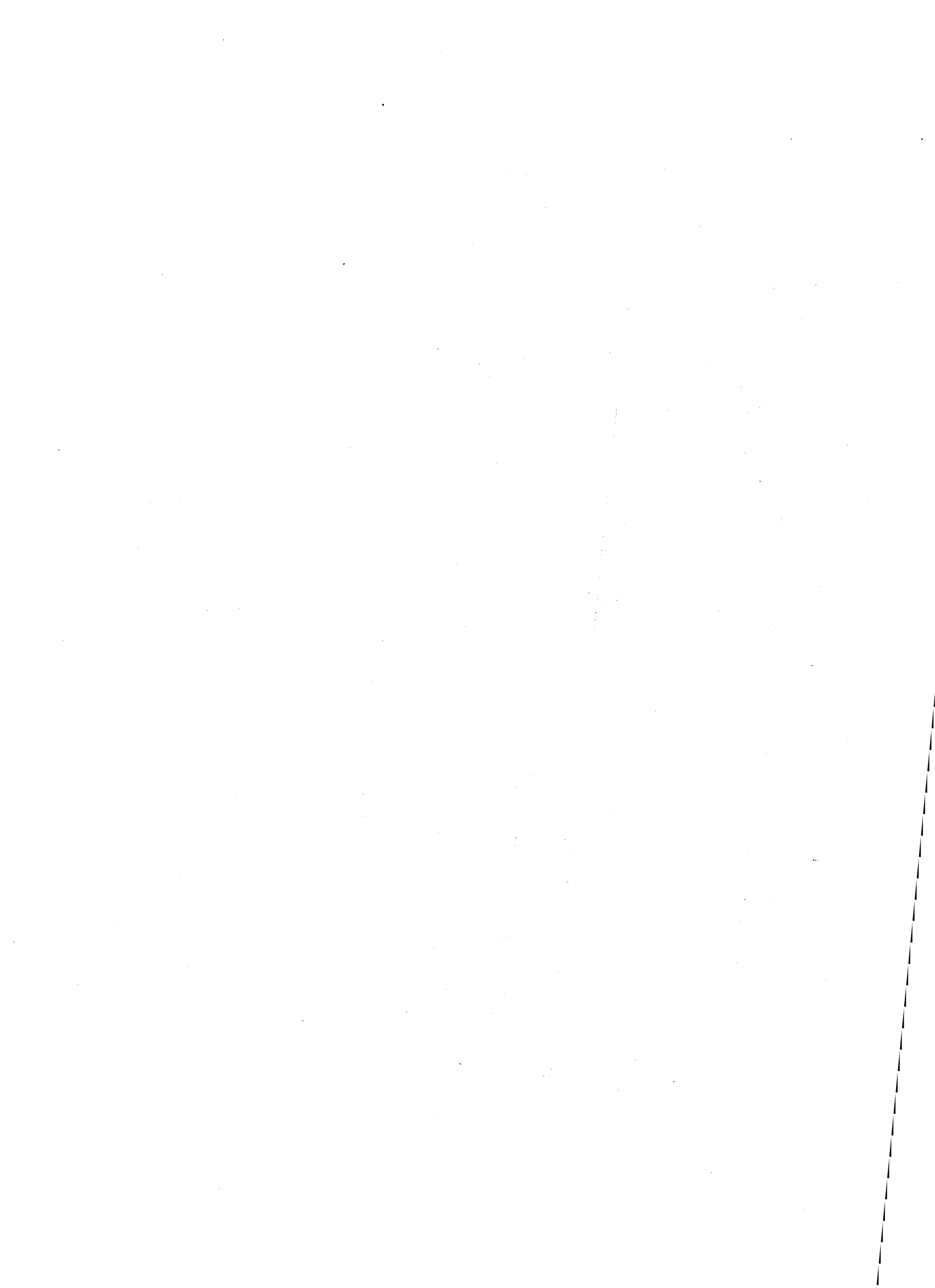

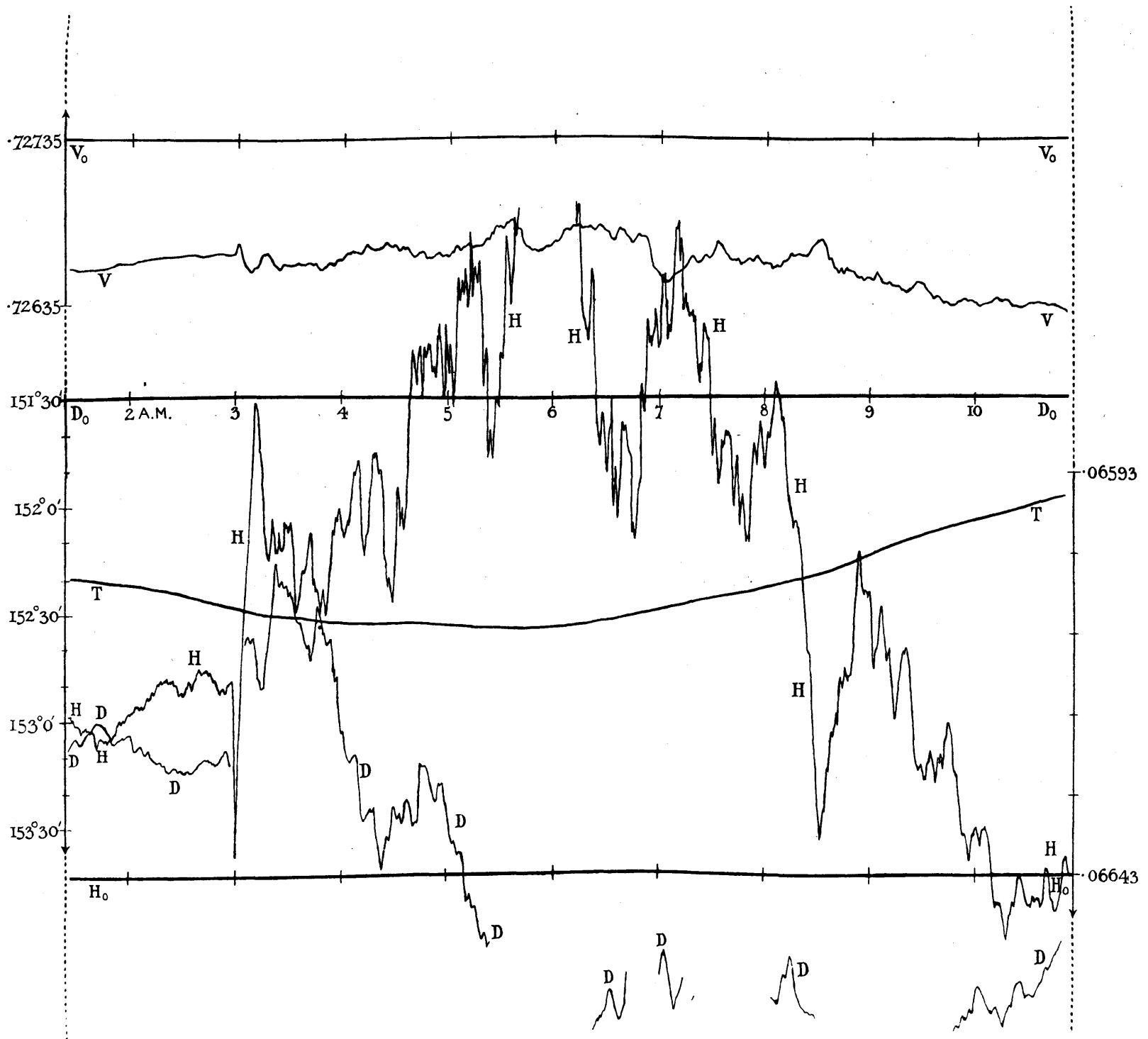

Disturbance of November 7, 1902, at Winter Quarters.

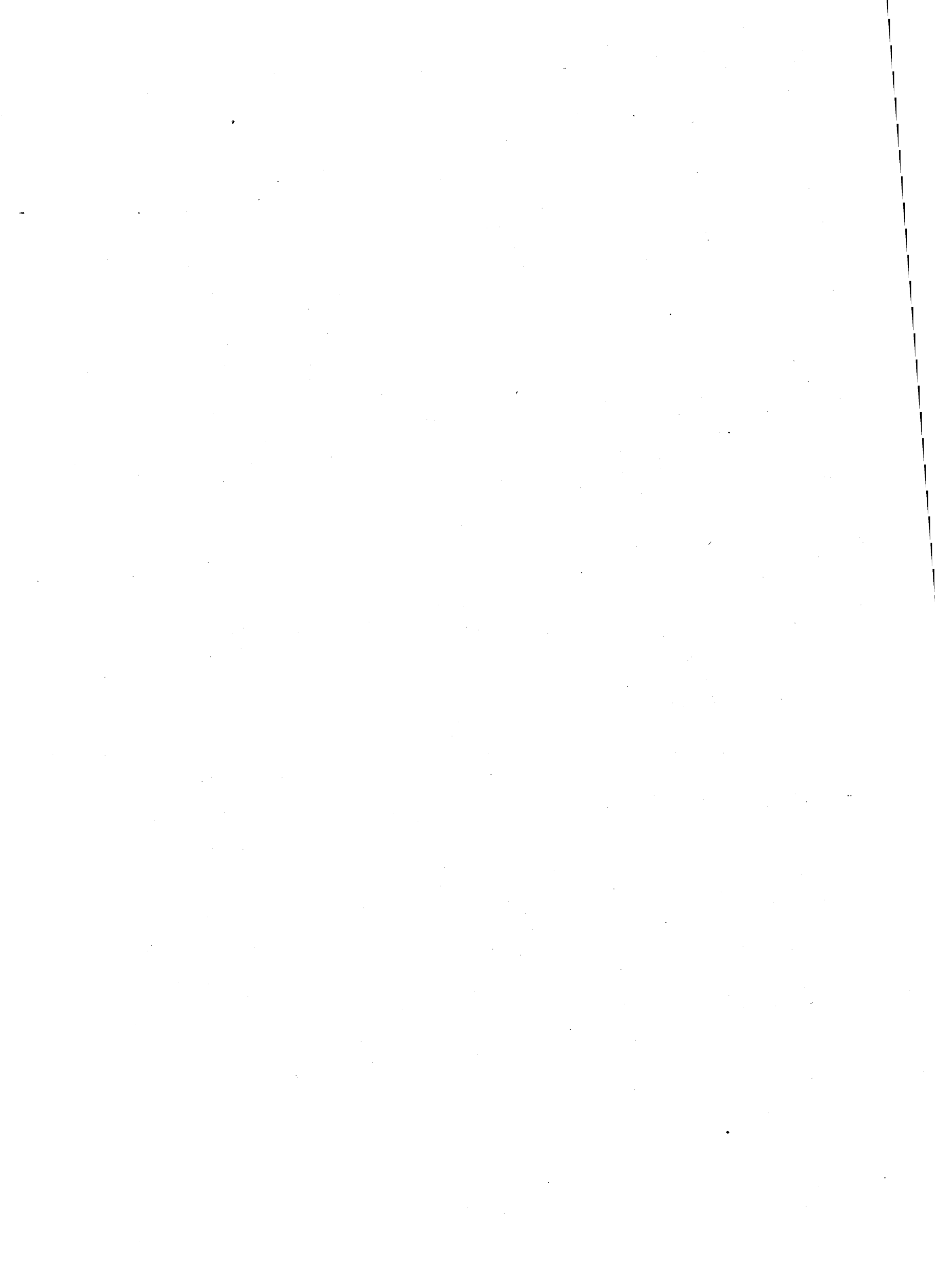

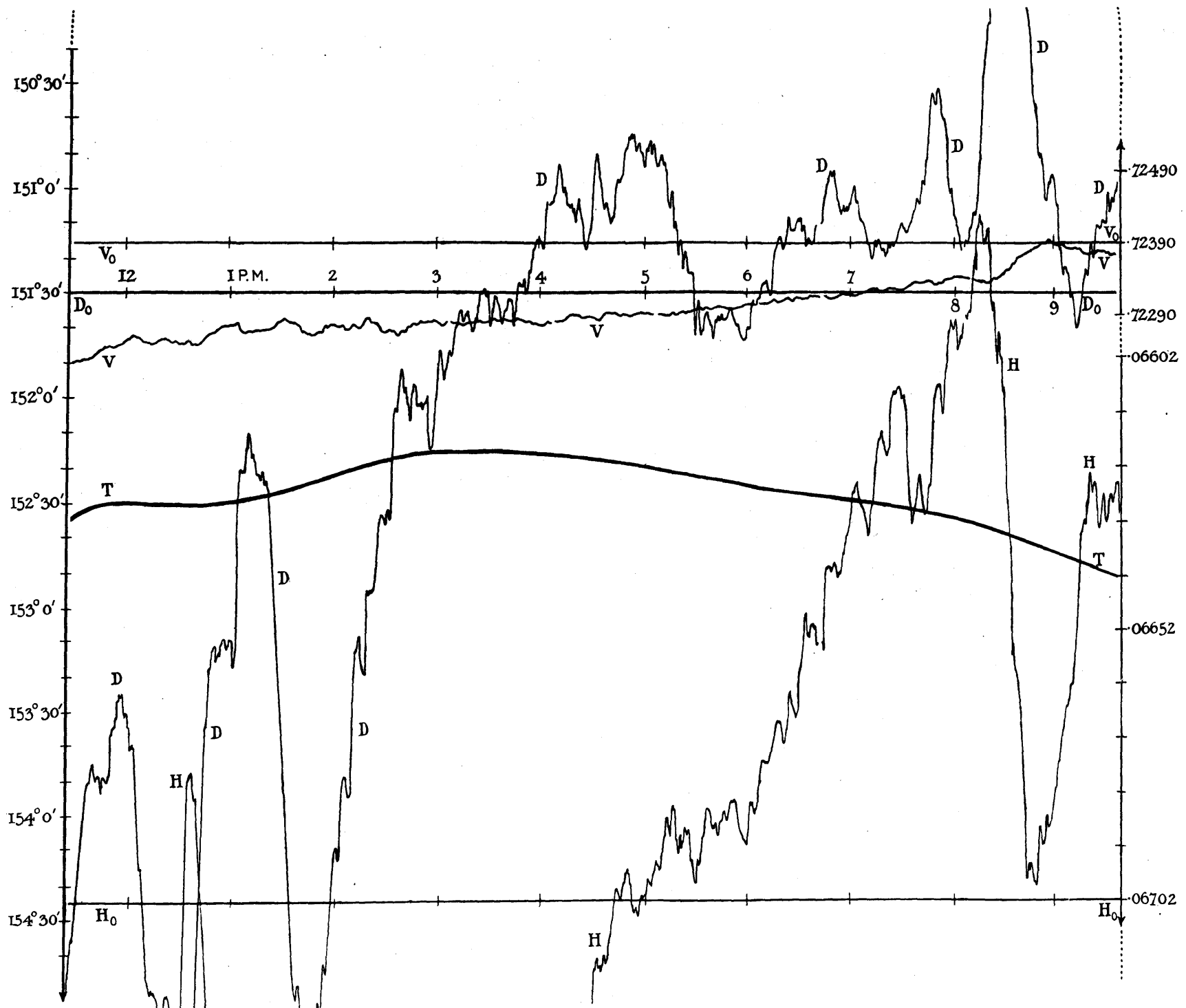

Disturbance of November 24, 1902, at Winter Quarters.



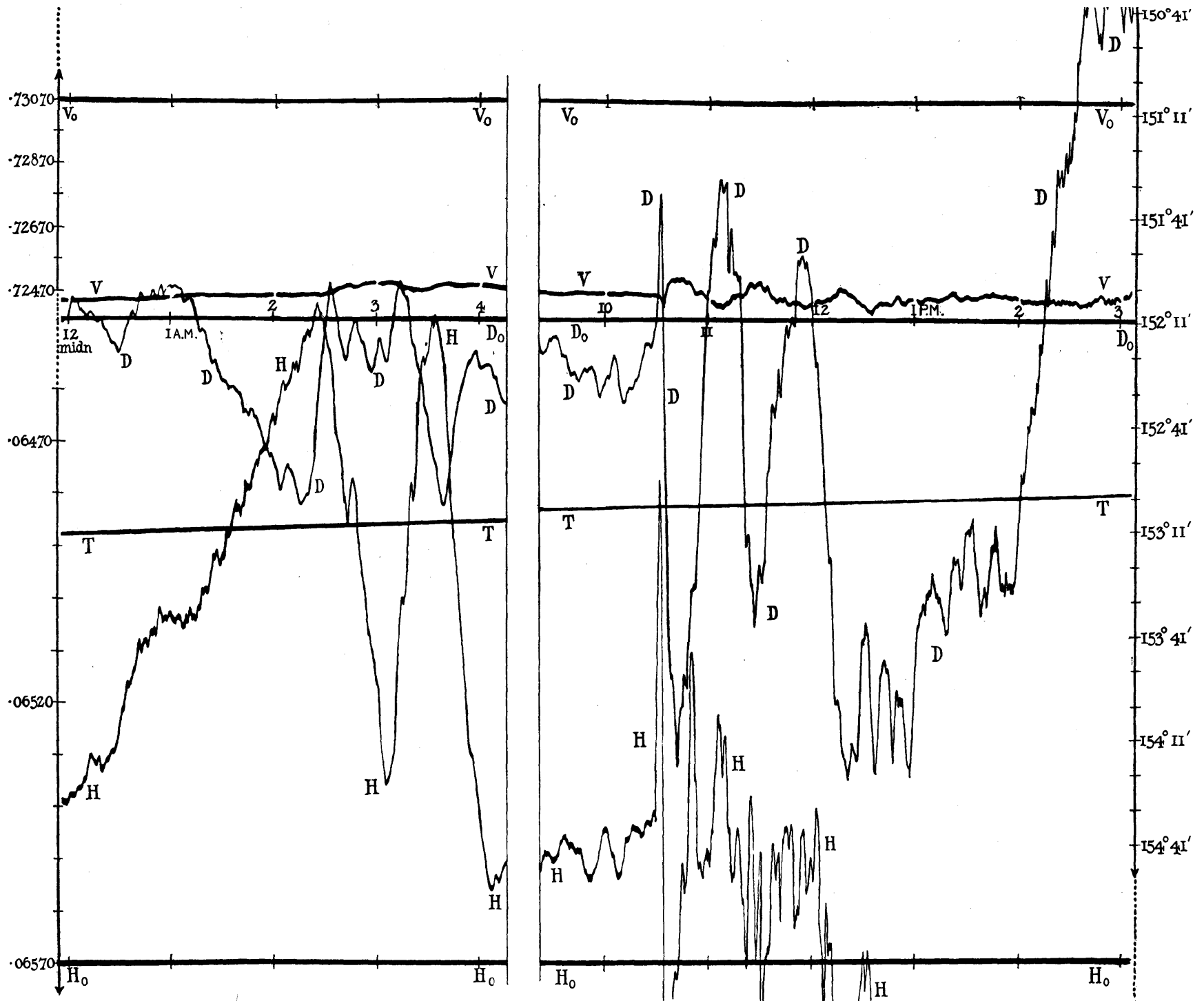

Disturbance of April 6, 1903, at Winter Quarters.



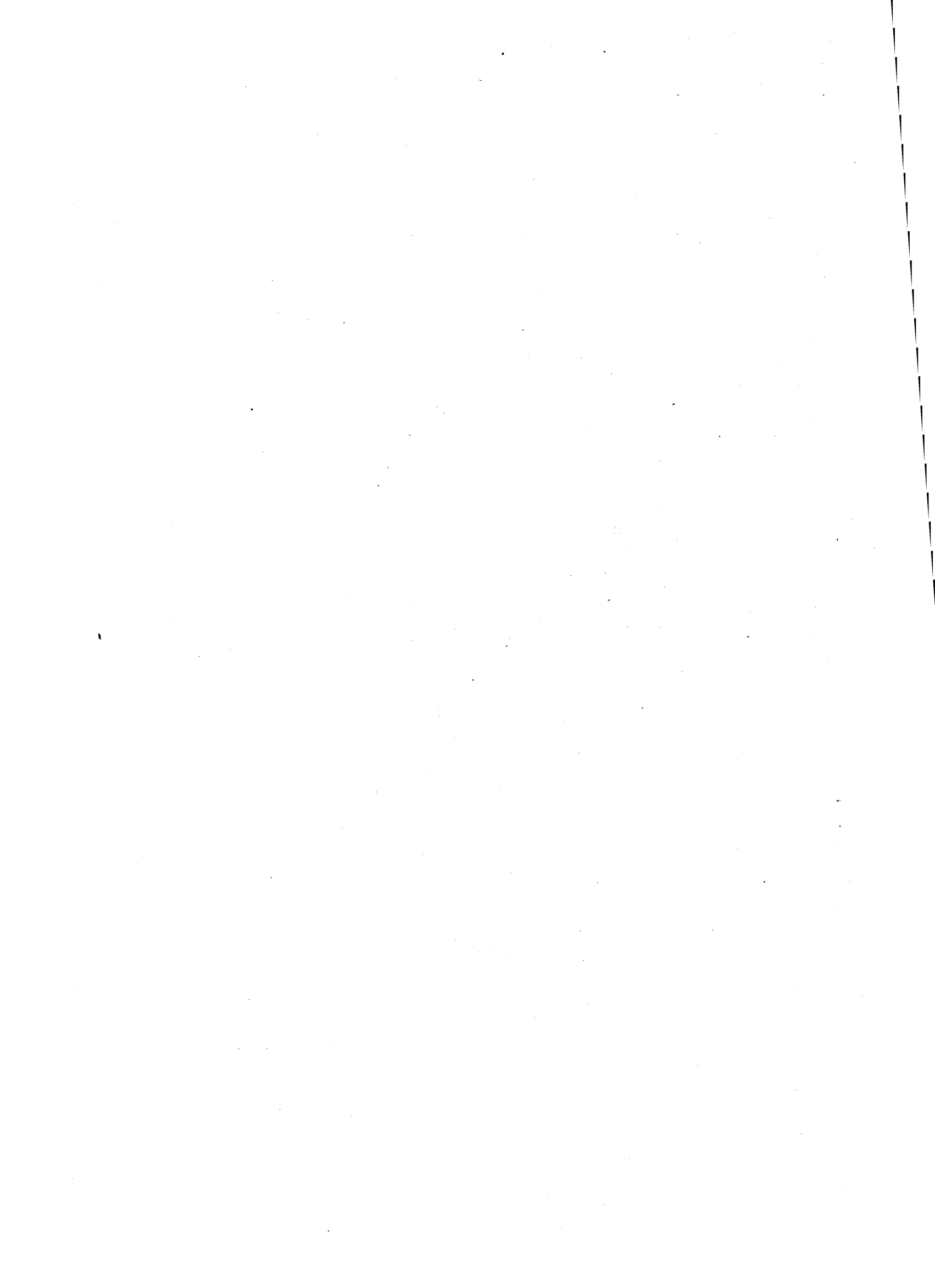

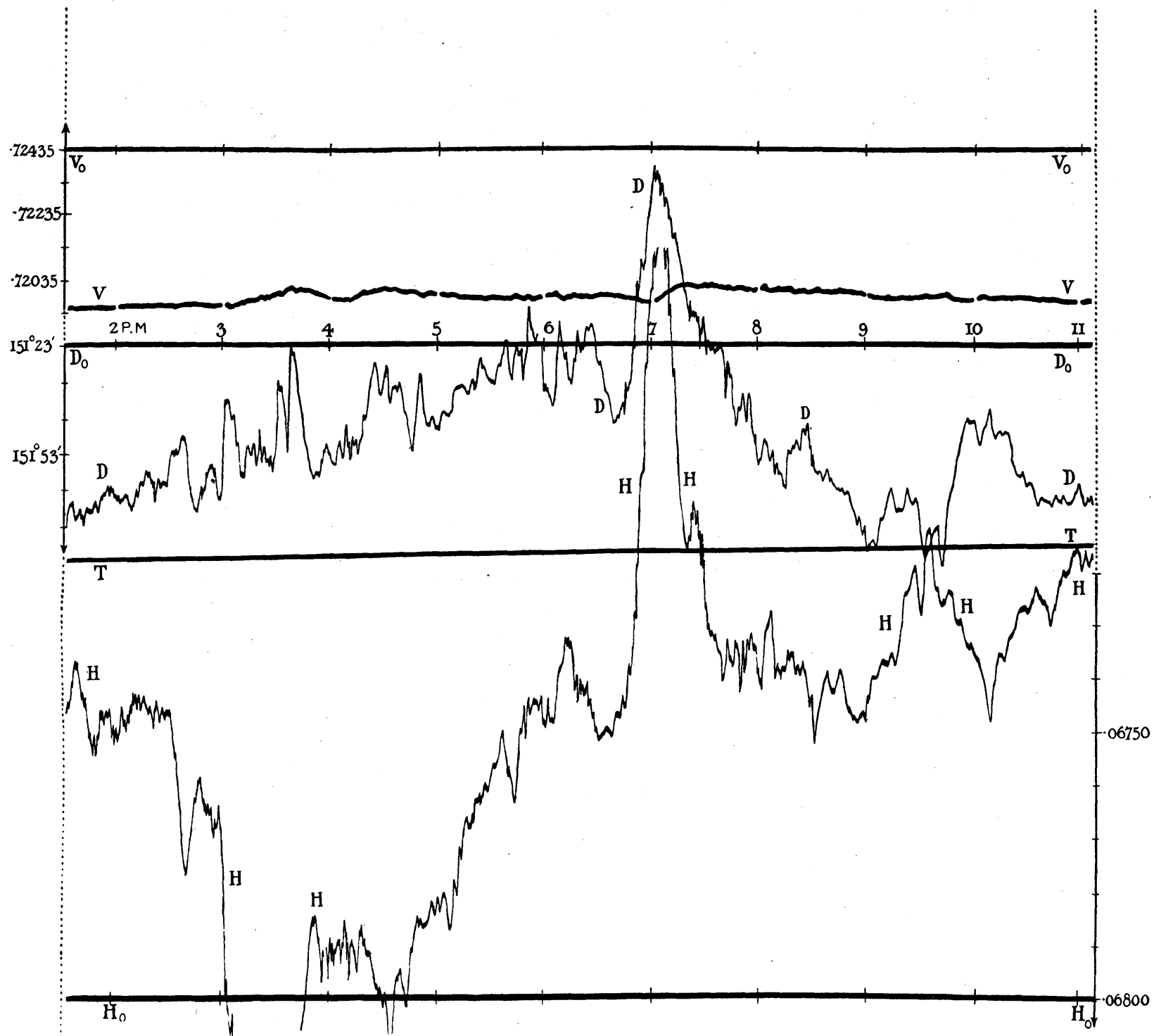

Disturbance of June 19, 1903, at Winter Quarters.



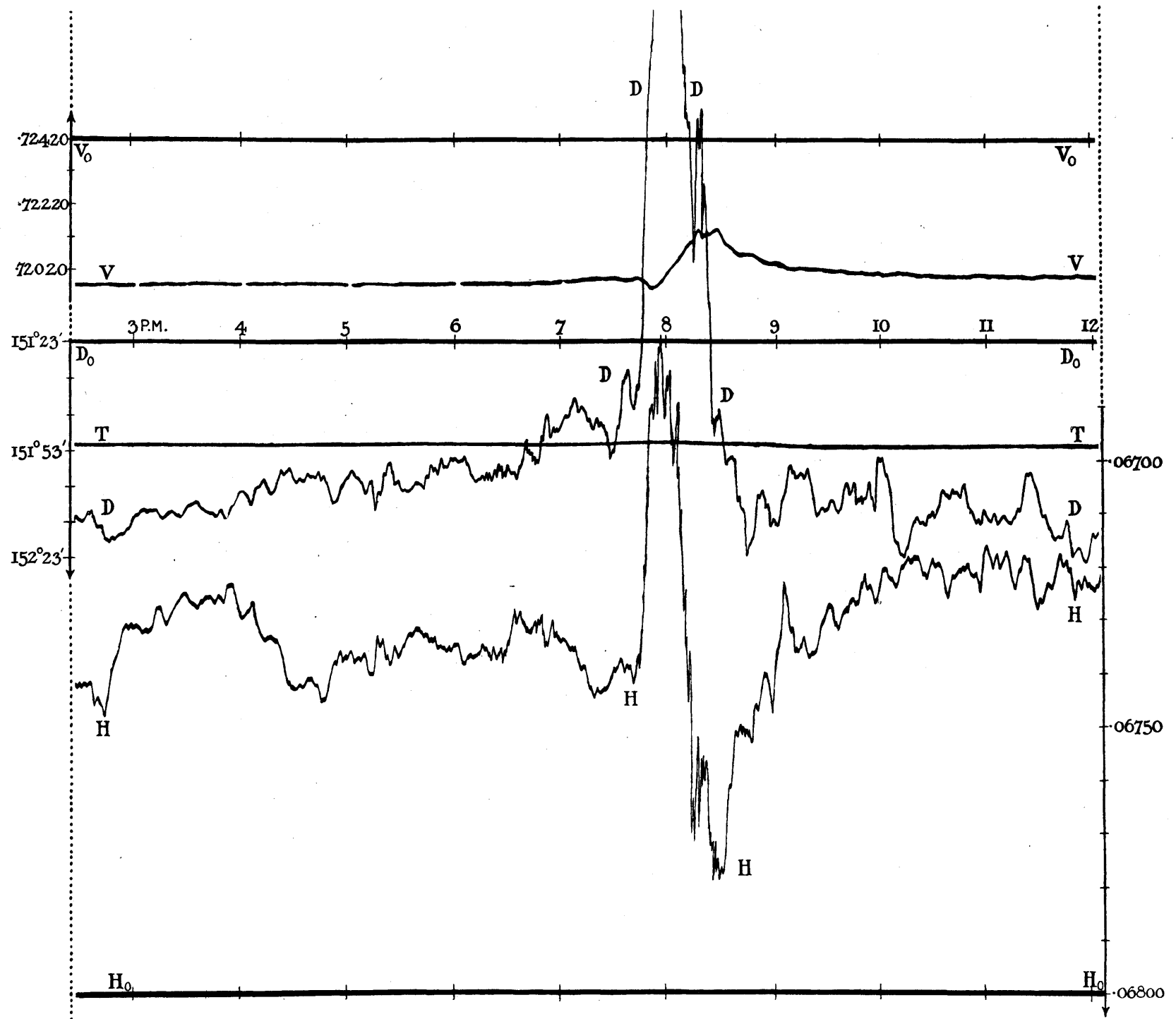

Disturbance of June 28, 1903, at Winter Quarters.



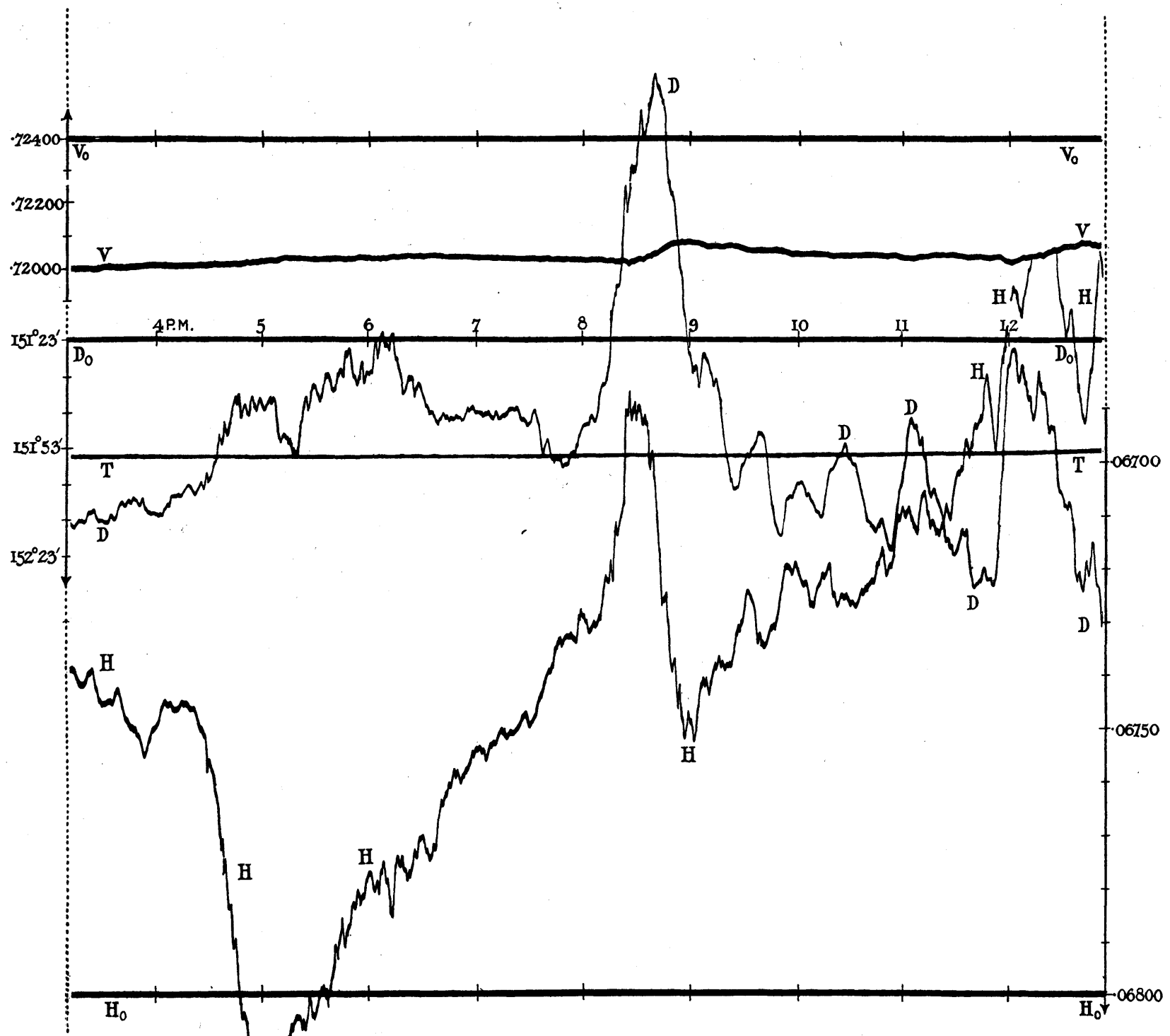

Disturbance of June 29, 1903, at Winter Quarters.

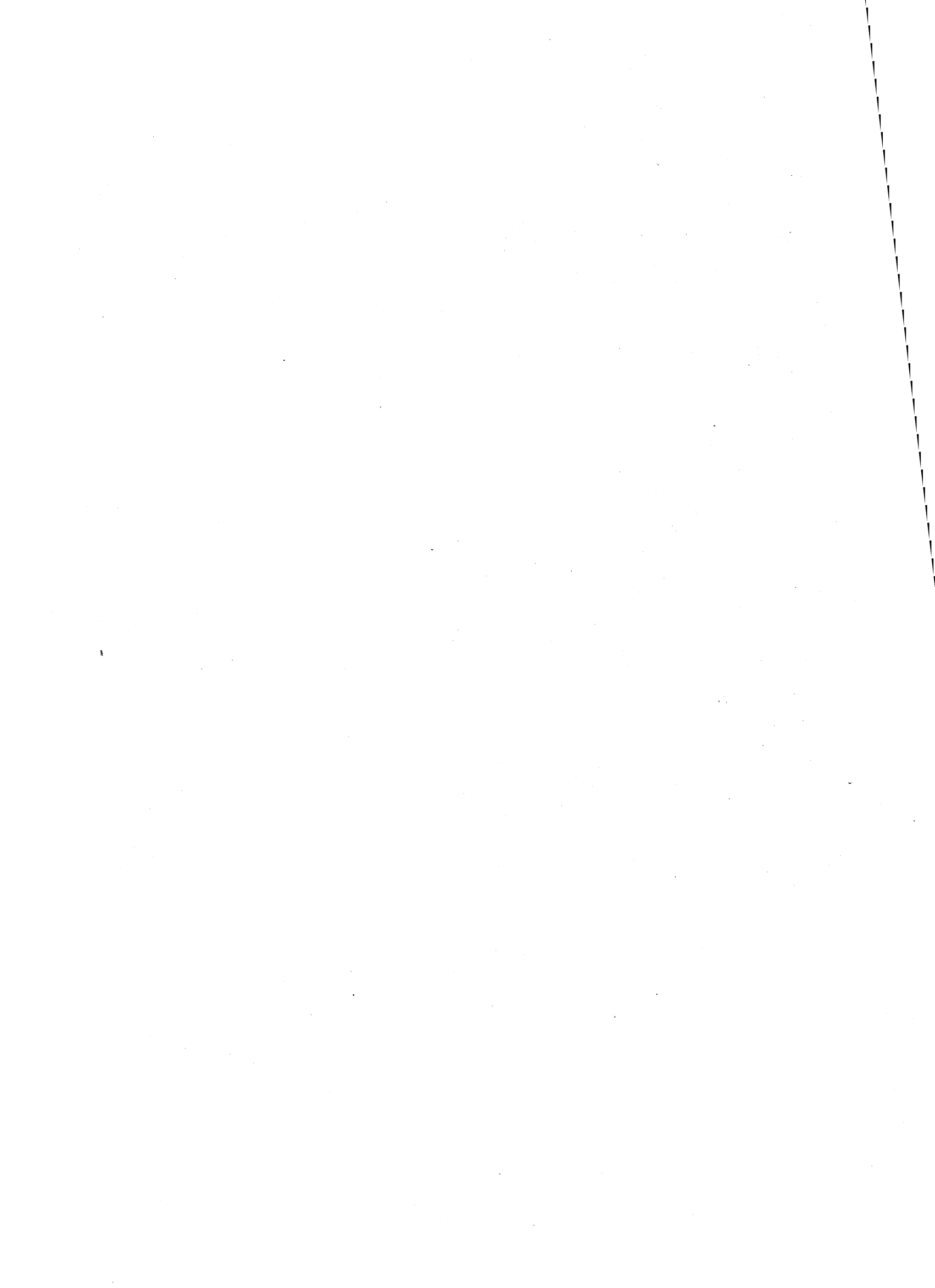

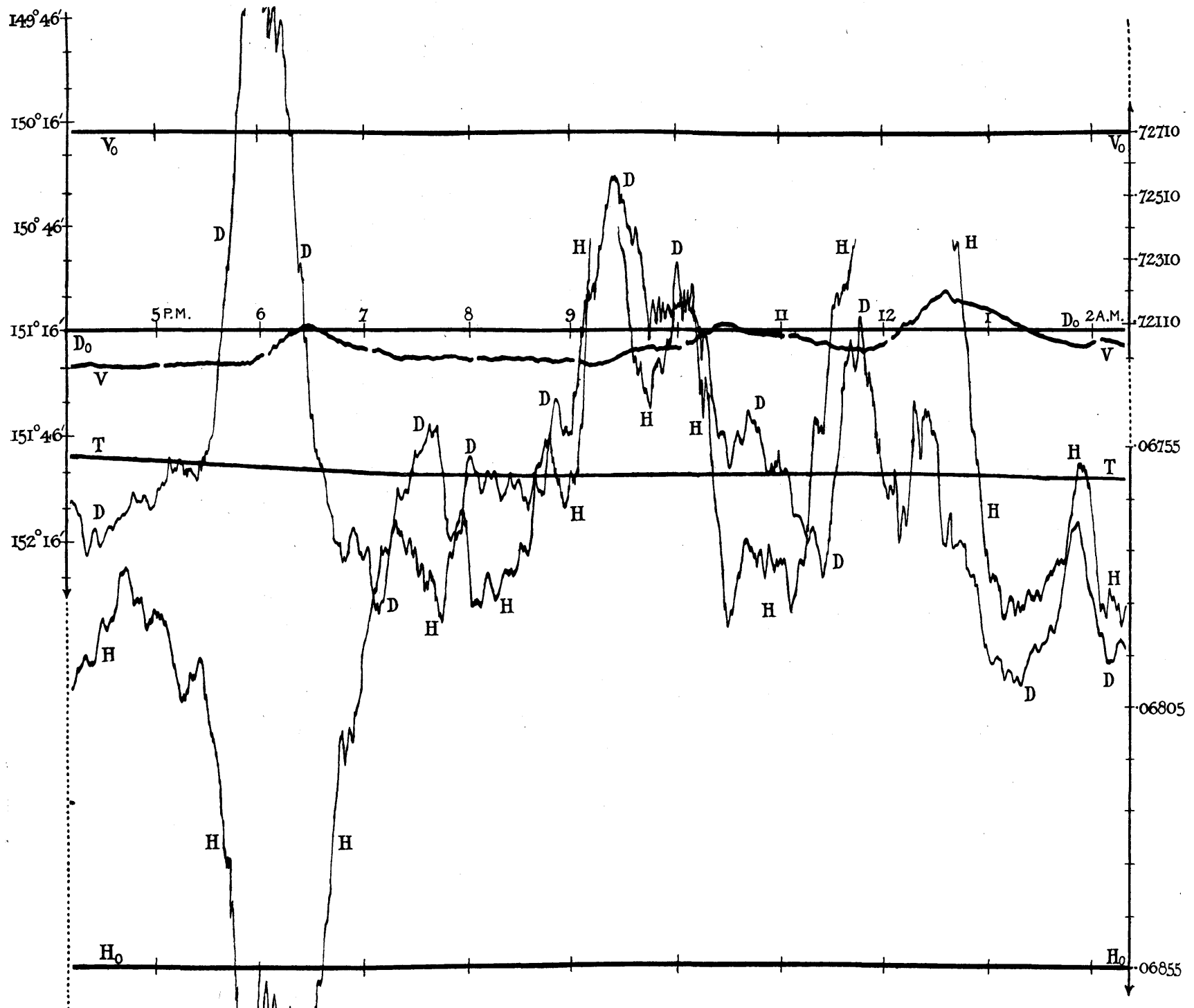

Disturbance of July 26, 1903, at Winter Quarters.





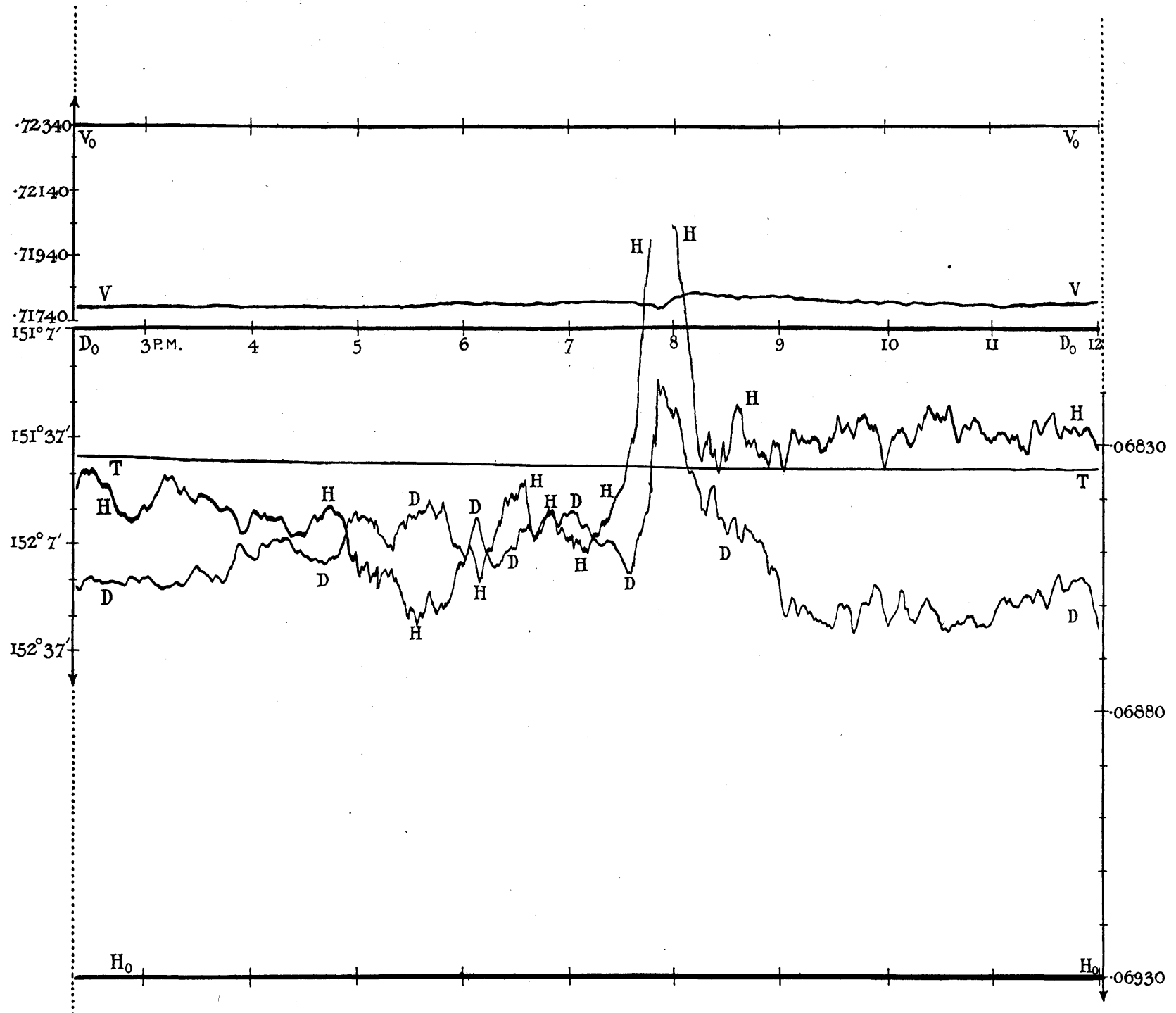

Disturbance of August 17, 1903, at Winter Quarters.





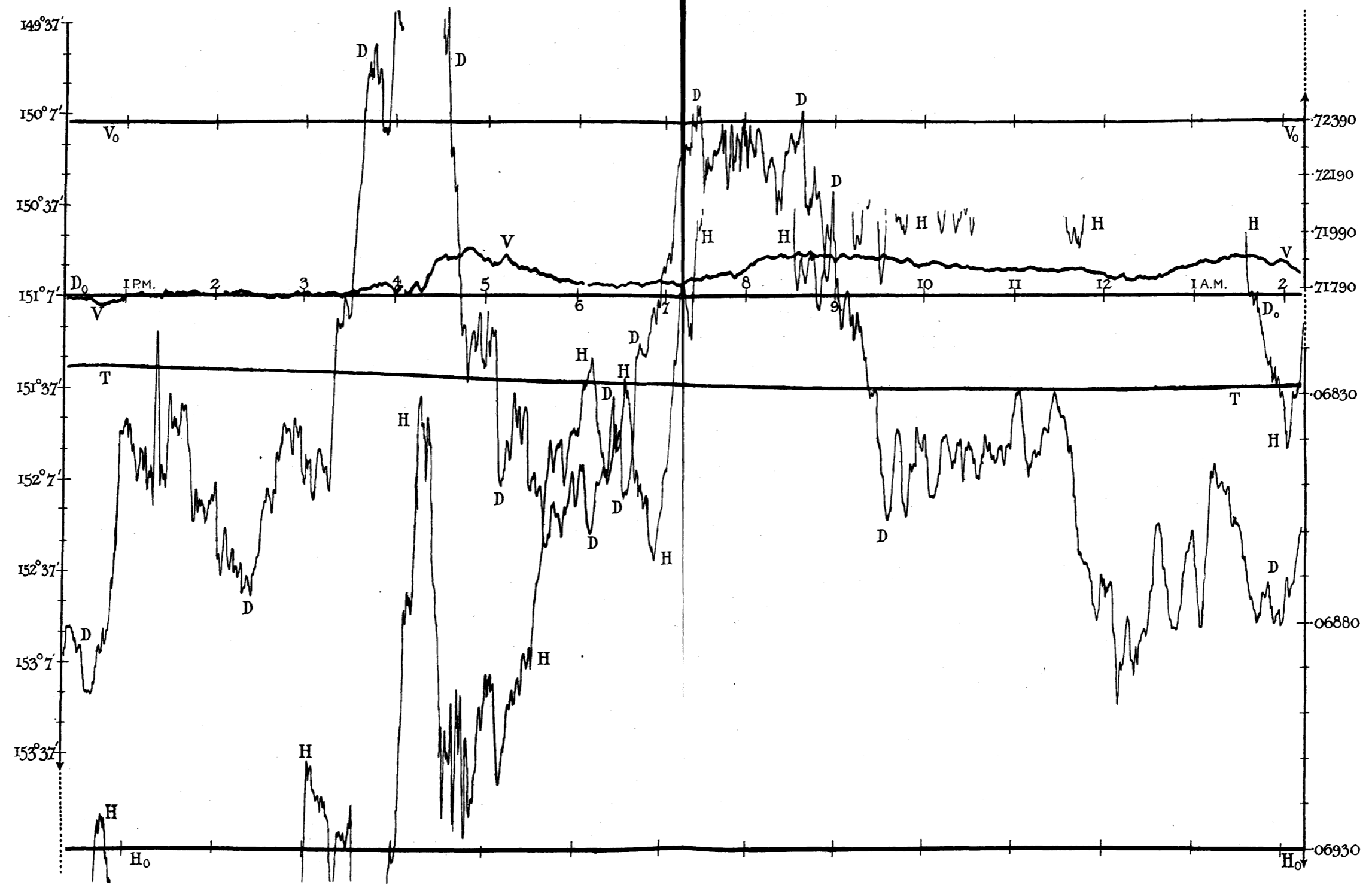

Disturbance of August 22 and 23, 1903, at Winter Quarters.



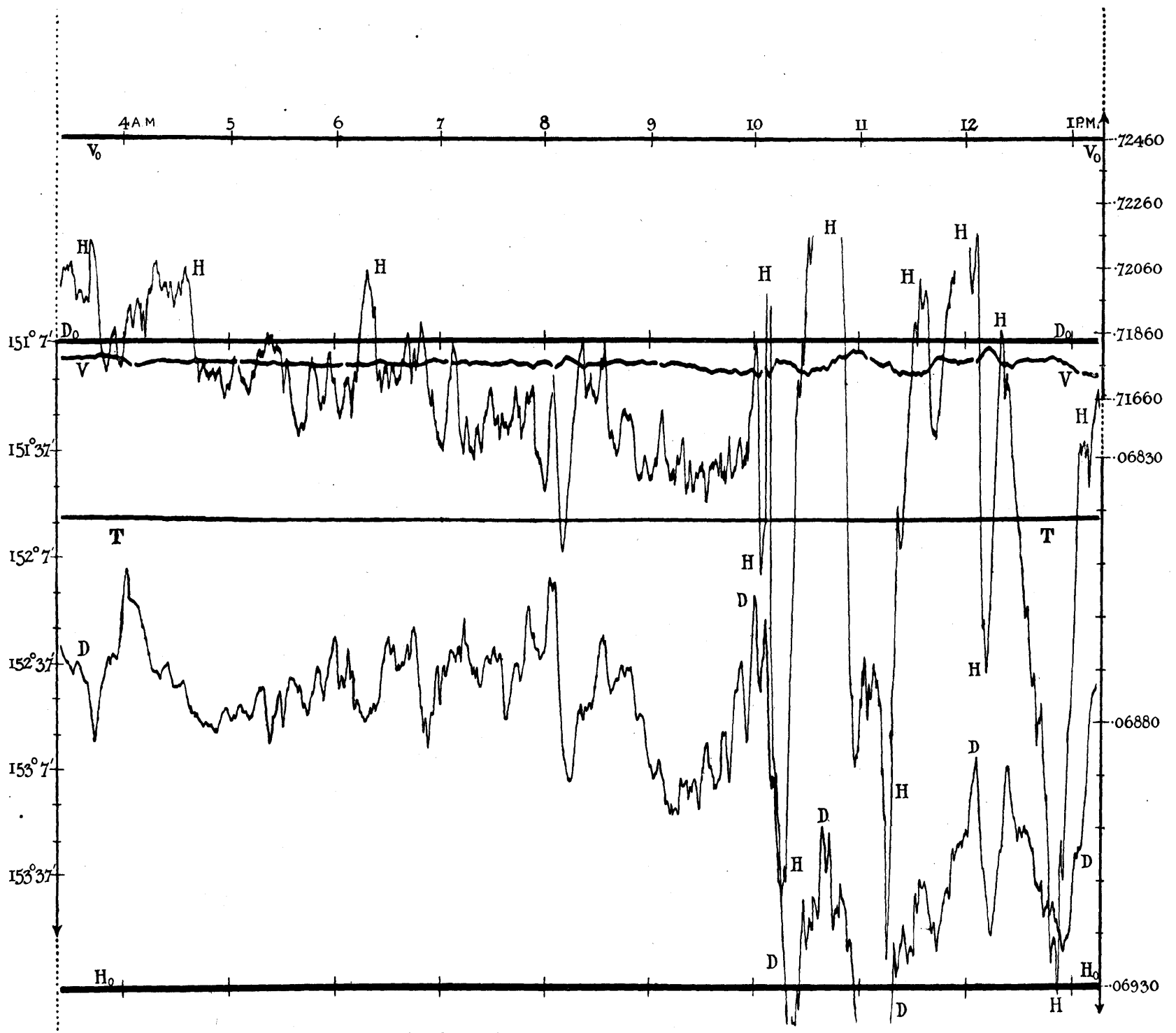

Disturbance of August 26, 1903, at Winter Quarters.

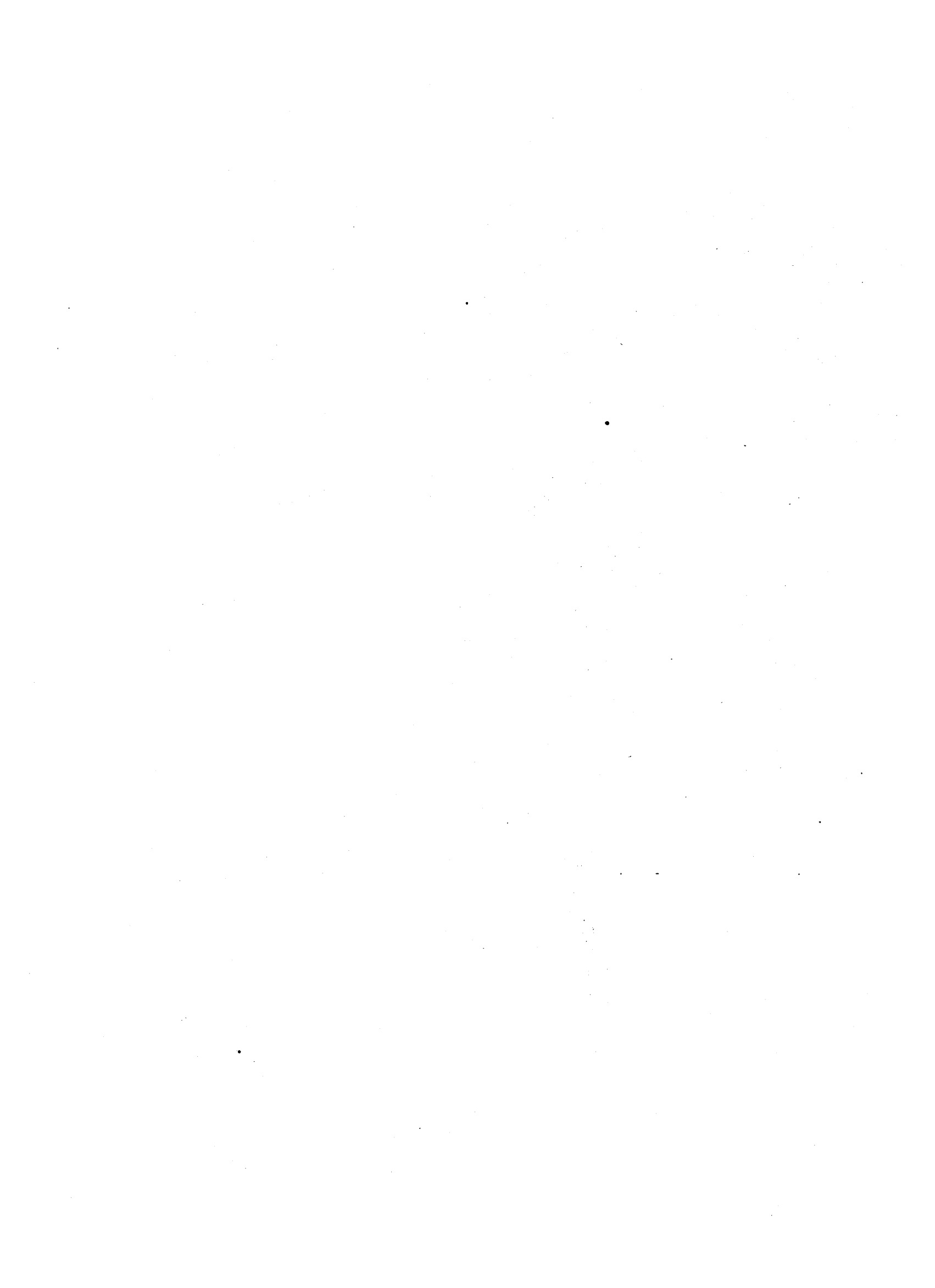



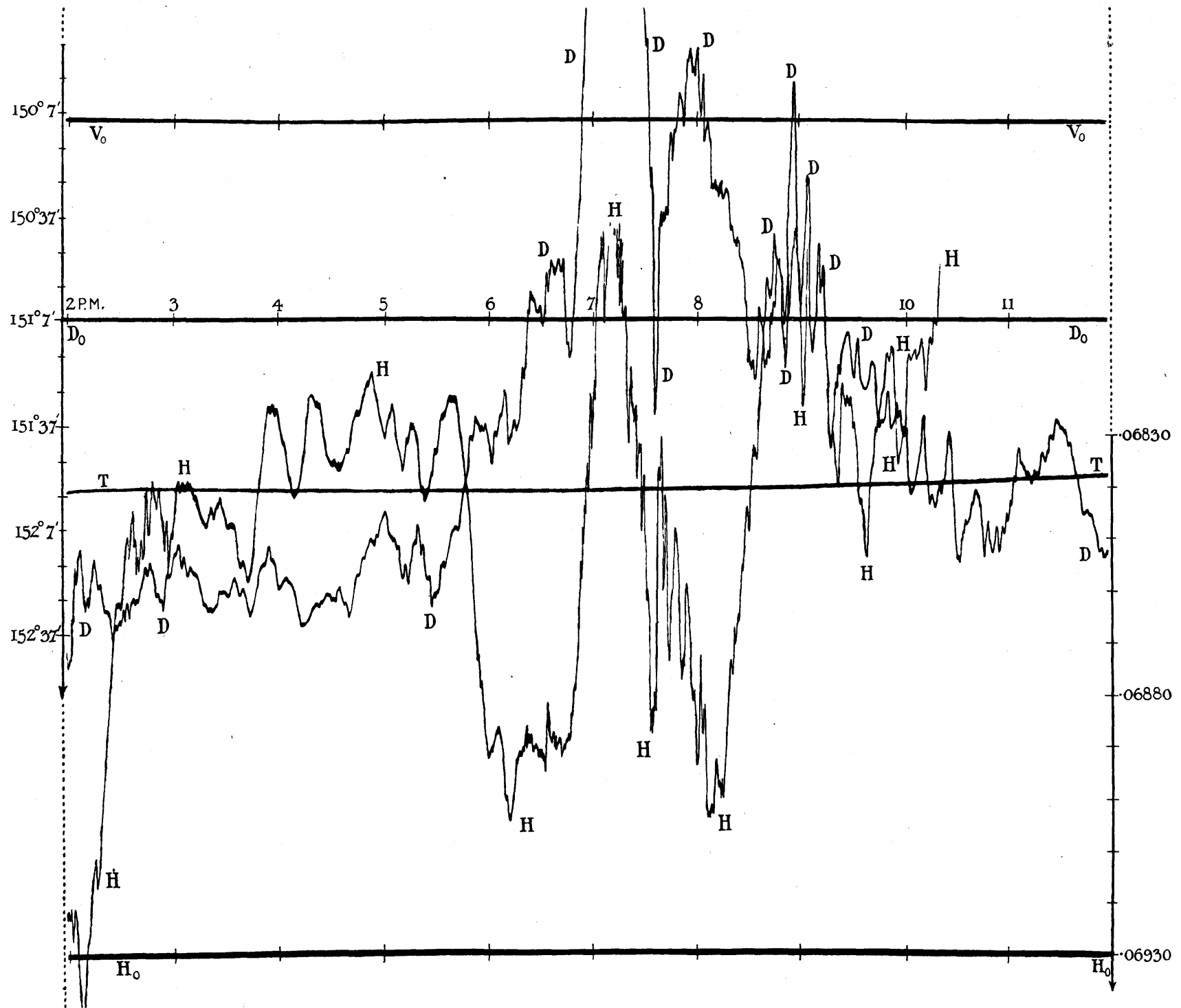

Disturbance of August 26, 1903, at Winter Quarters.



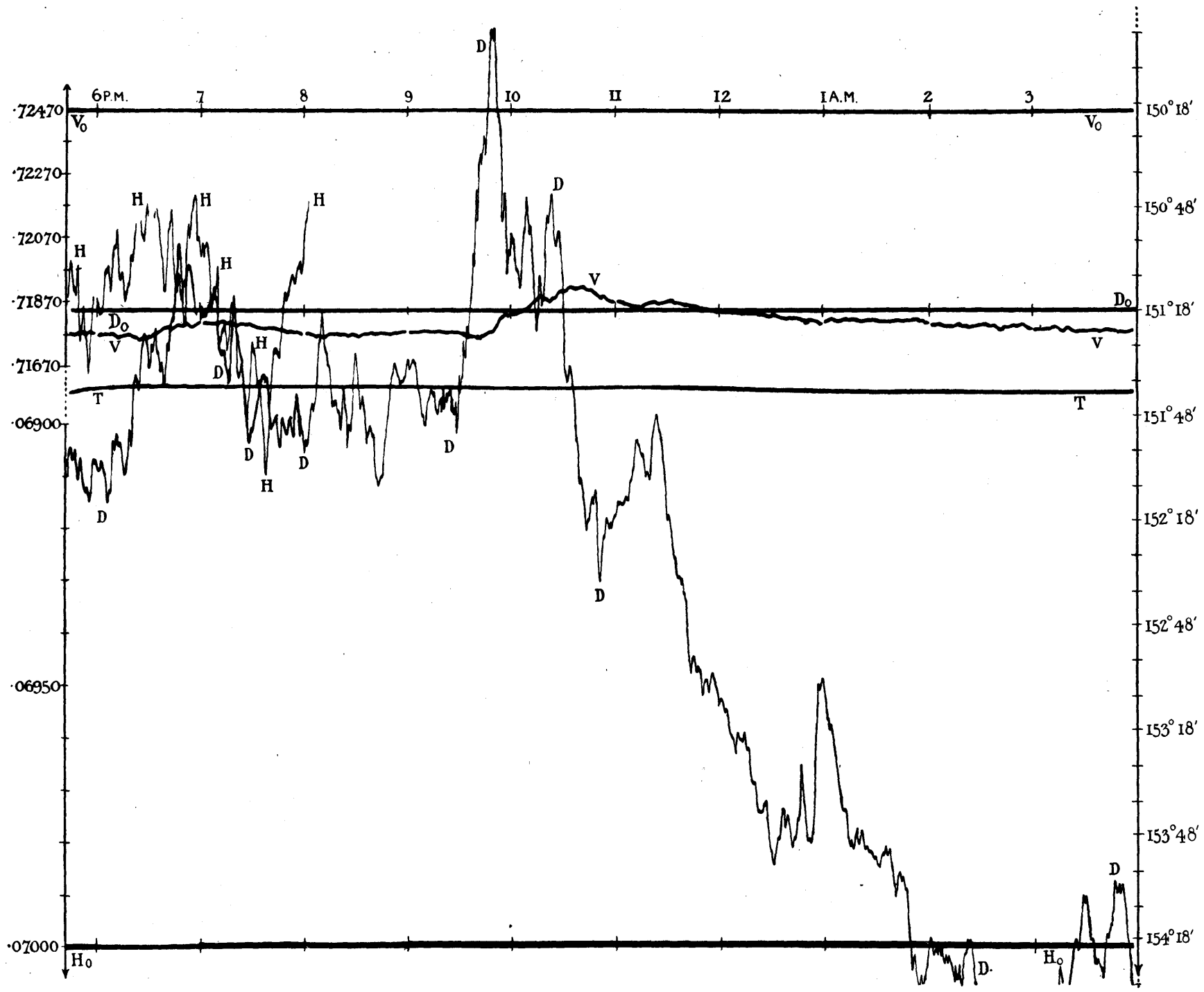

Disturbance of October 12 and 13, 1903, at Winter Quarters.

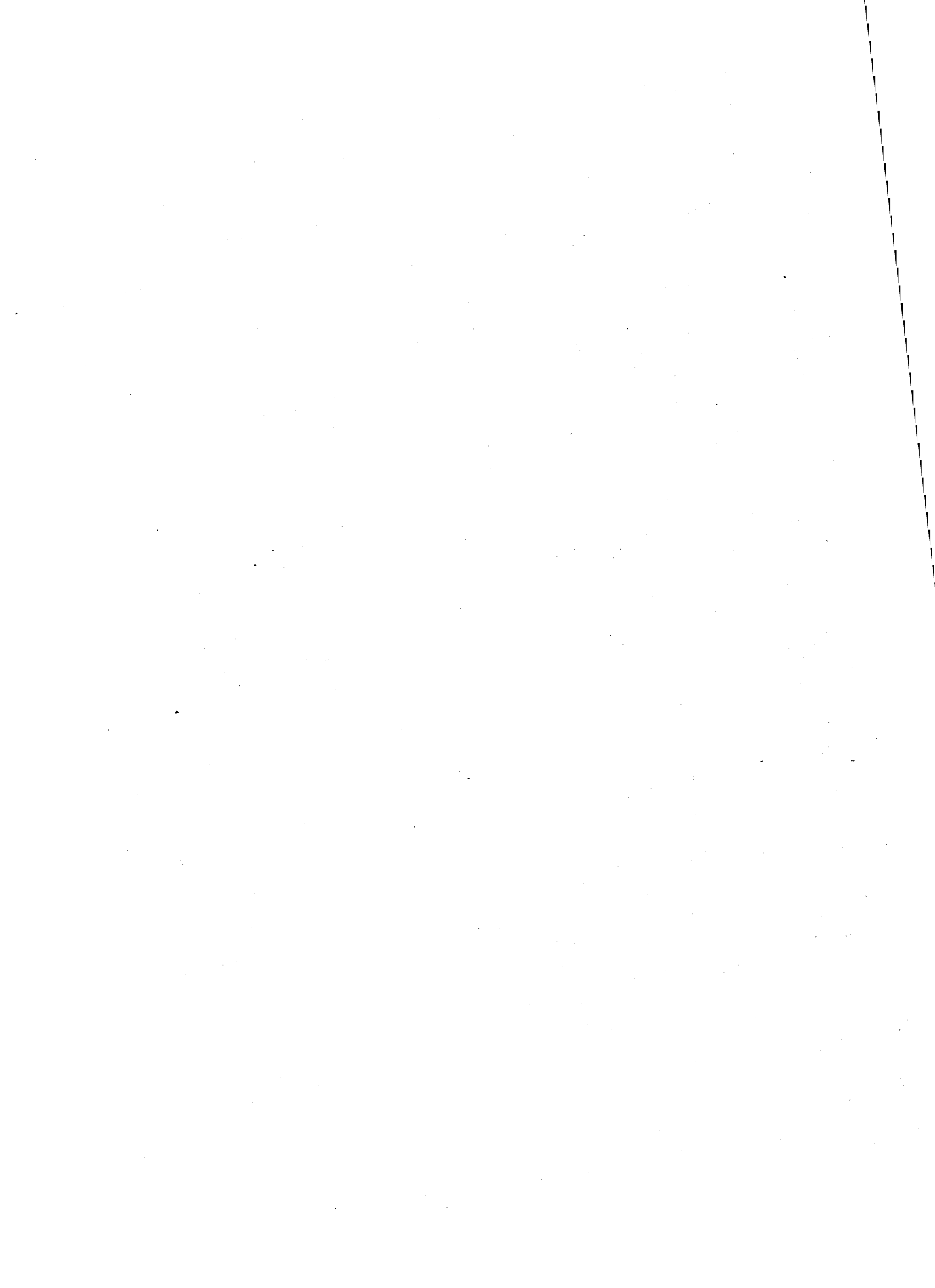

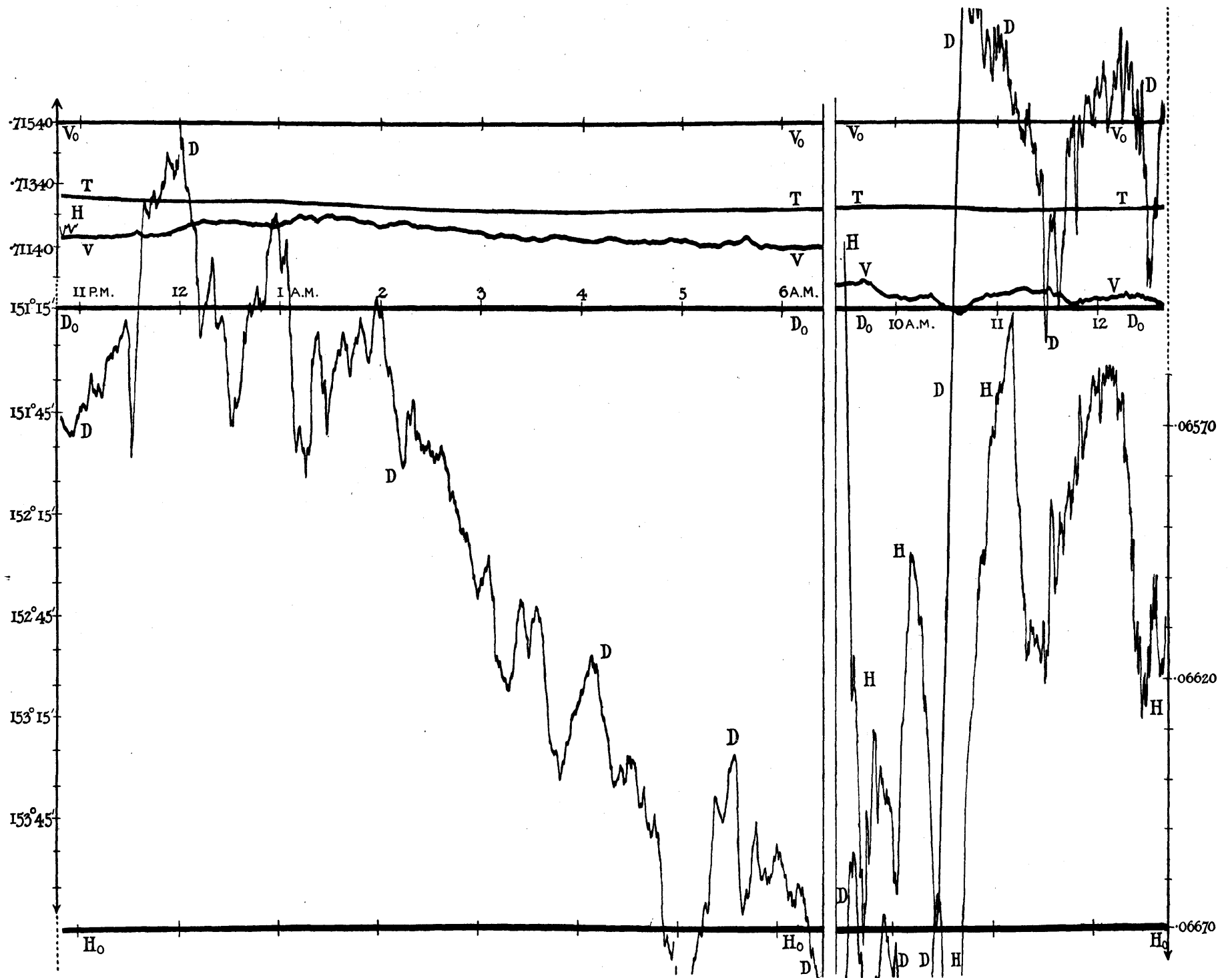

Disturbance of December 13 and 14, 1903, at Winter Quarters.



May 22, 1903.

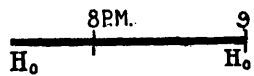
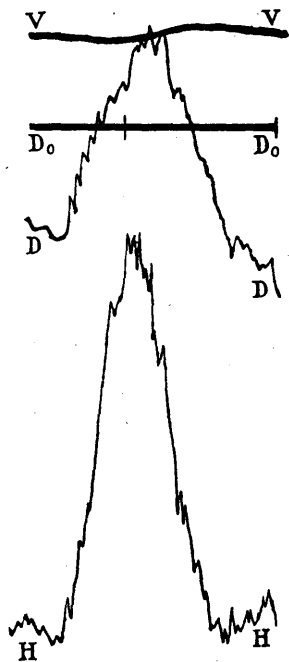

D 52'; H 53y; V 29y.

August 31, 1902.

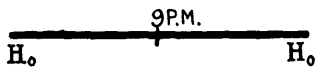
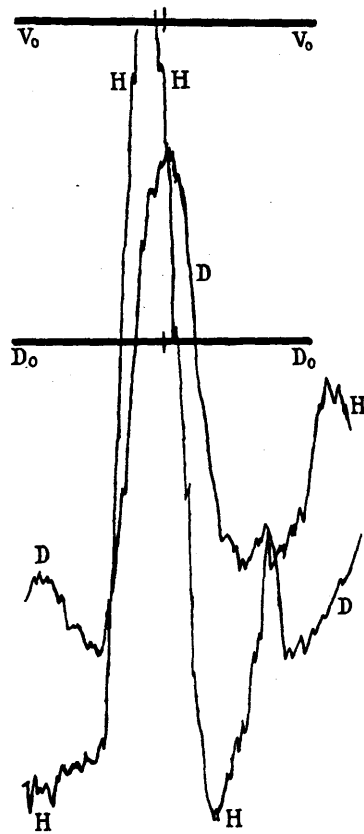

D 1°39'; H 71y; V 74y.

August 15, 1903.

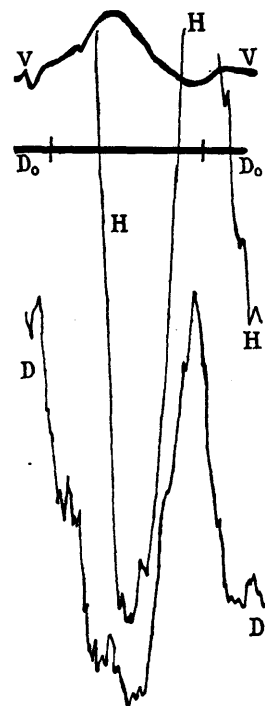

D 1°21'; H 77y; V 162y.

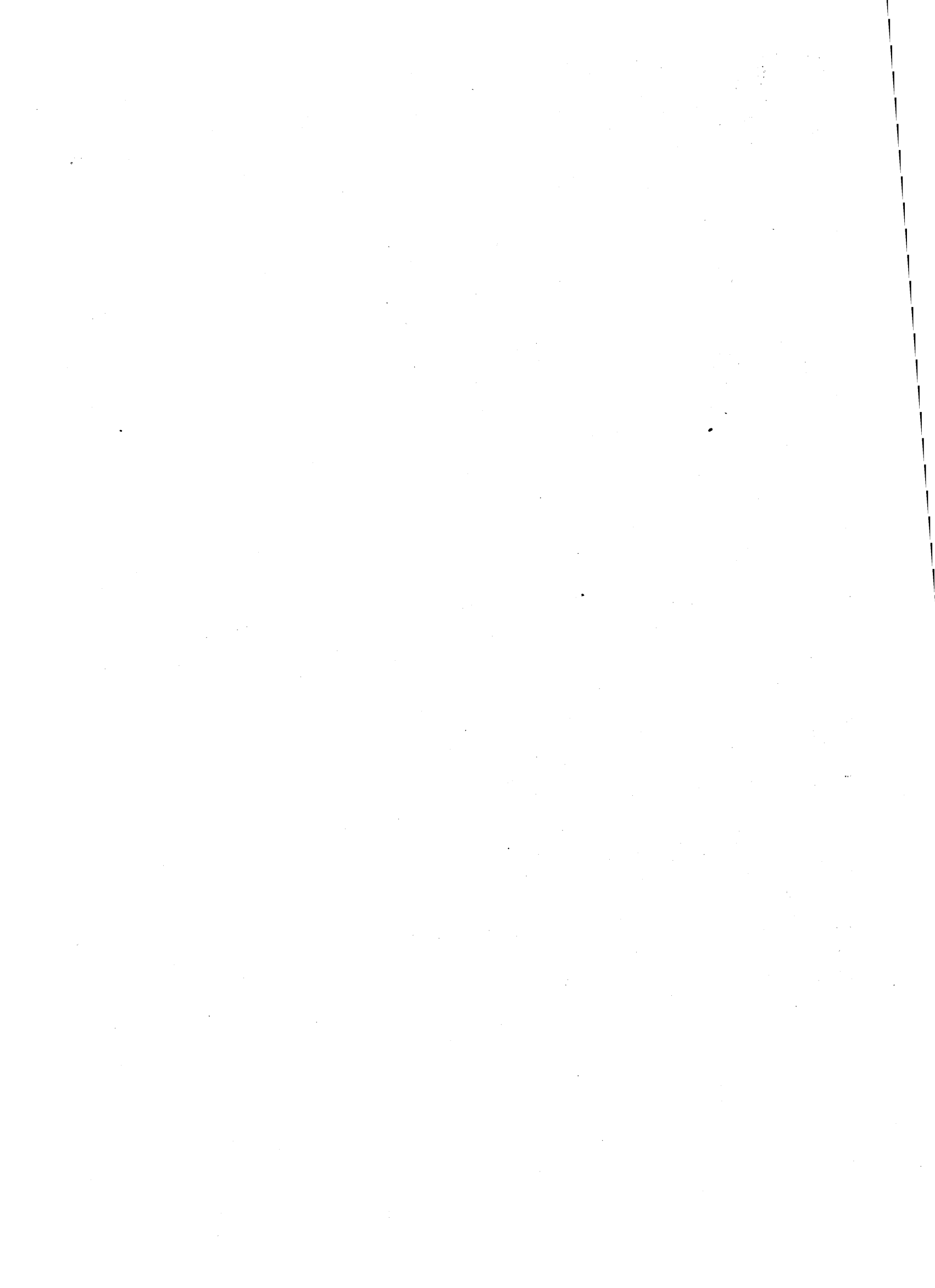



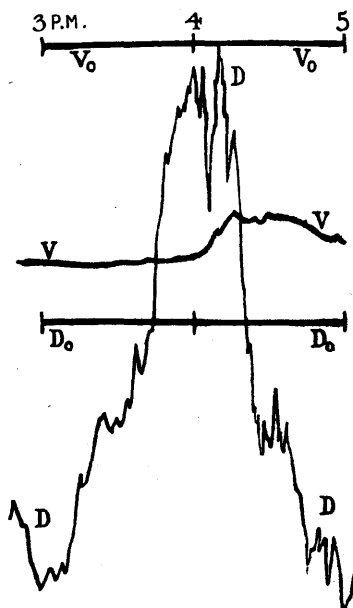

June 4, 1903.

D 1° 51'  
 H 45γ  
 V 113γ

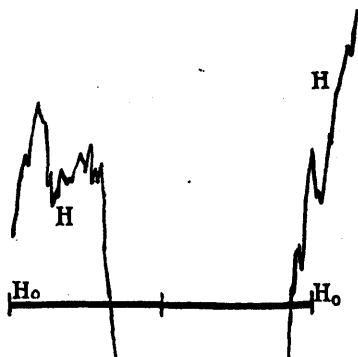

Oct 4-5, 1902.

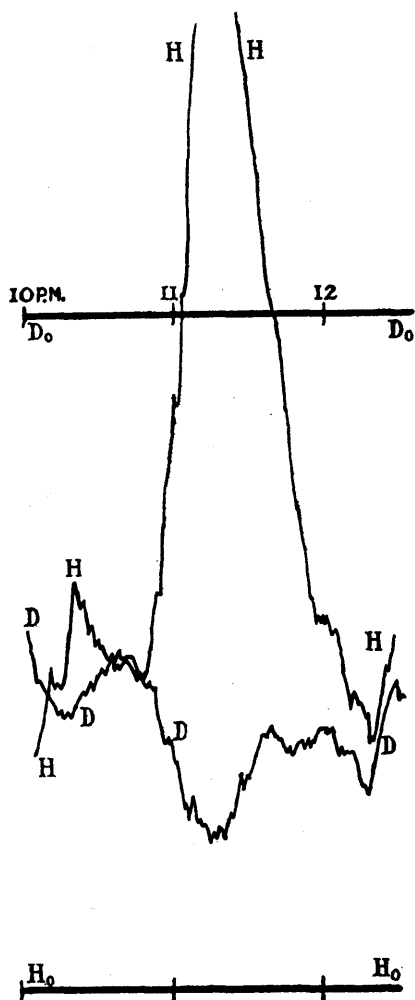

D 42'  
 H 64γ

Oct. 11-12, 1902.

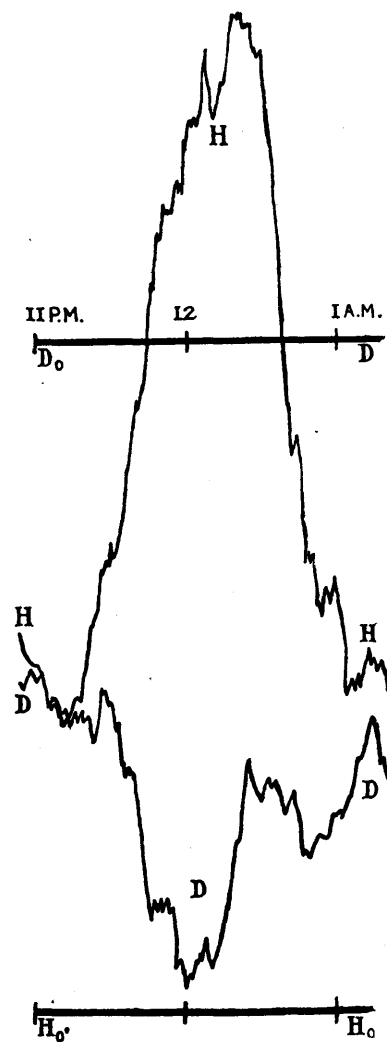

D 1° 2'  
 H 61γ



September 6-7, 1902.

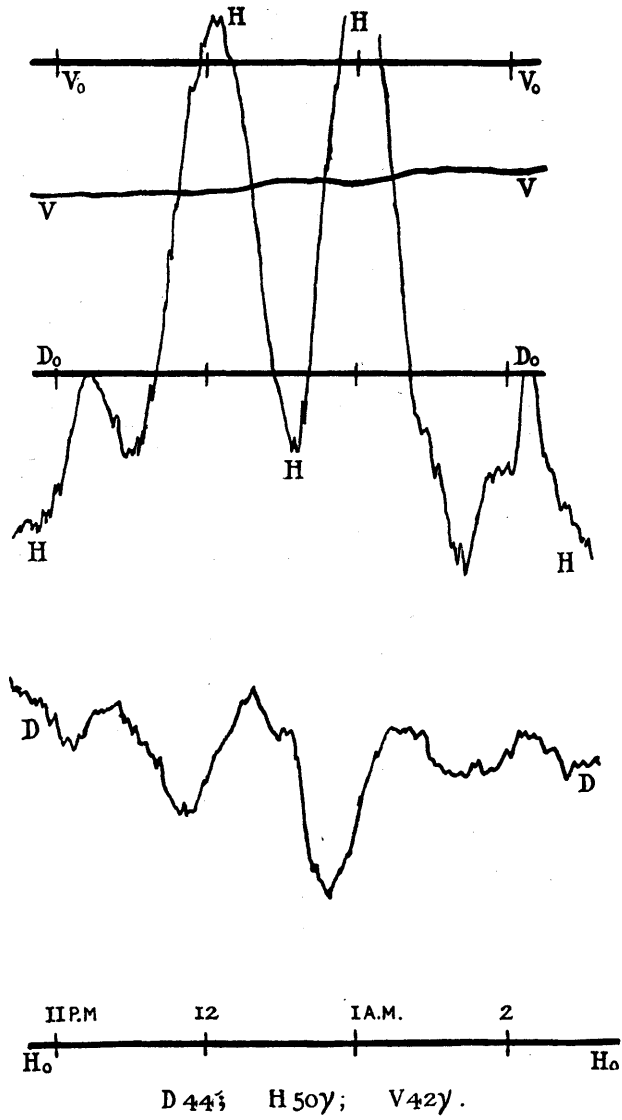

September 18-19, 1902.

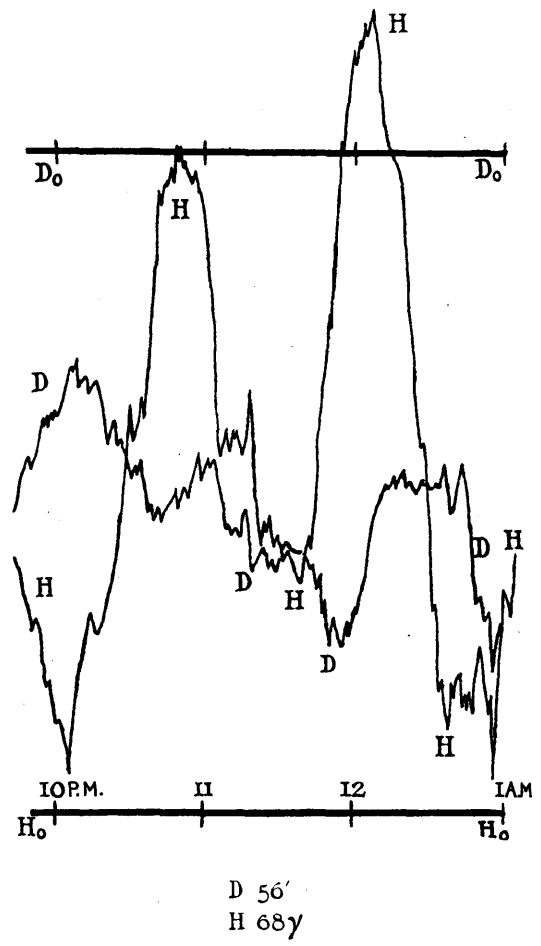



June 21-22, 1902.

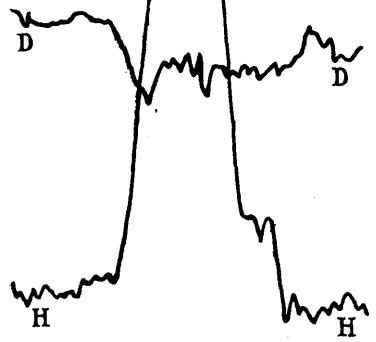
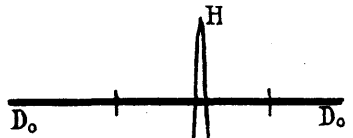
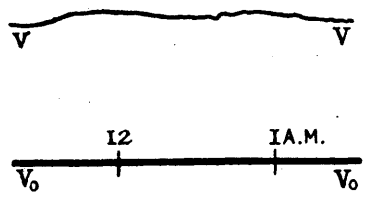

D 20'  
H 117γ  
V 29γ

July 9, 1902.

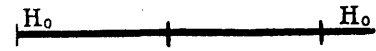
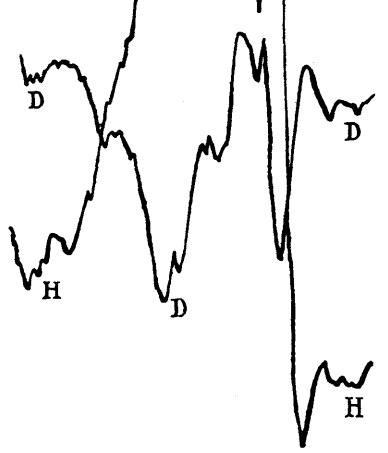
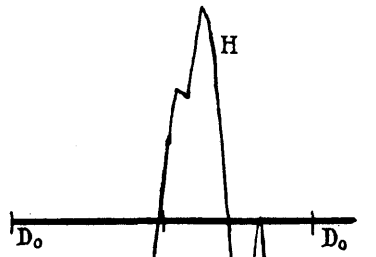
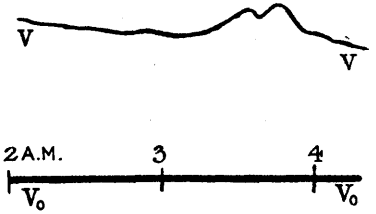

D 52'  
H 158γ  
V 74γ

January 10, 1903.

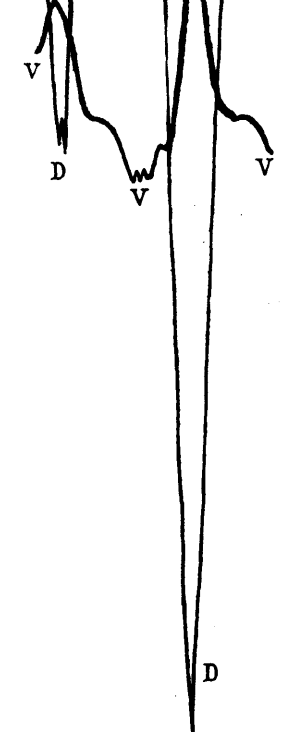
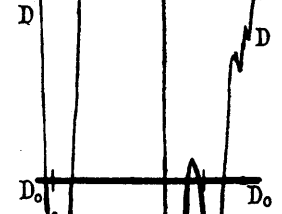
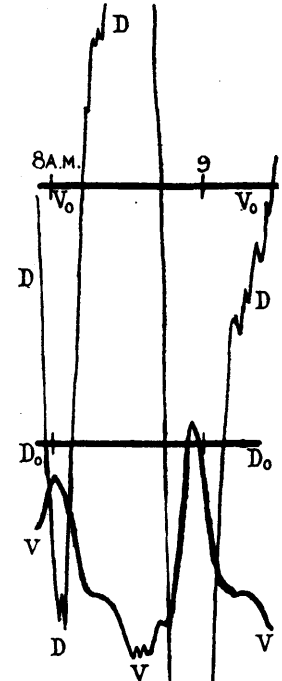

D 3° 58'  
V 257γ

December 10, 1902.

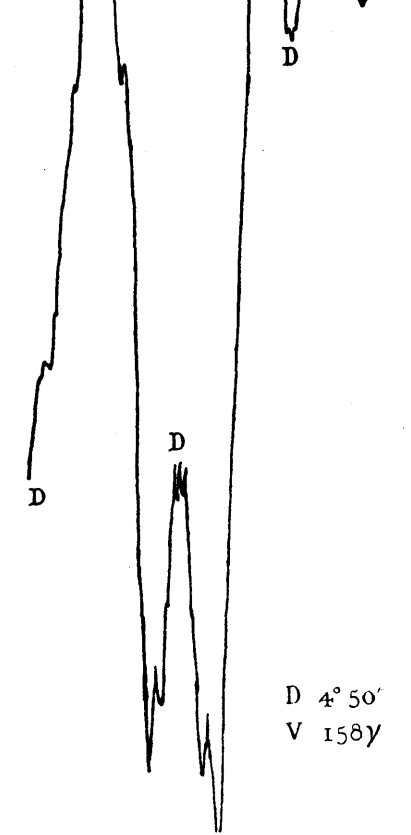
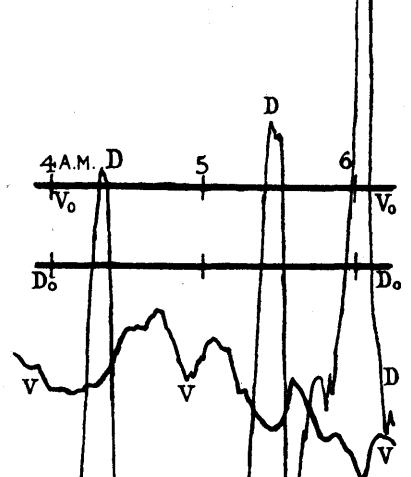

D 4° 50'  
V 158γ

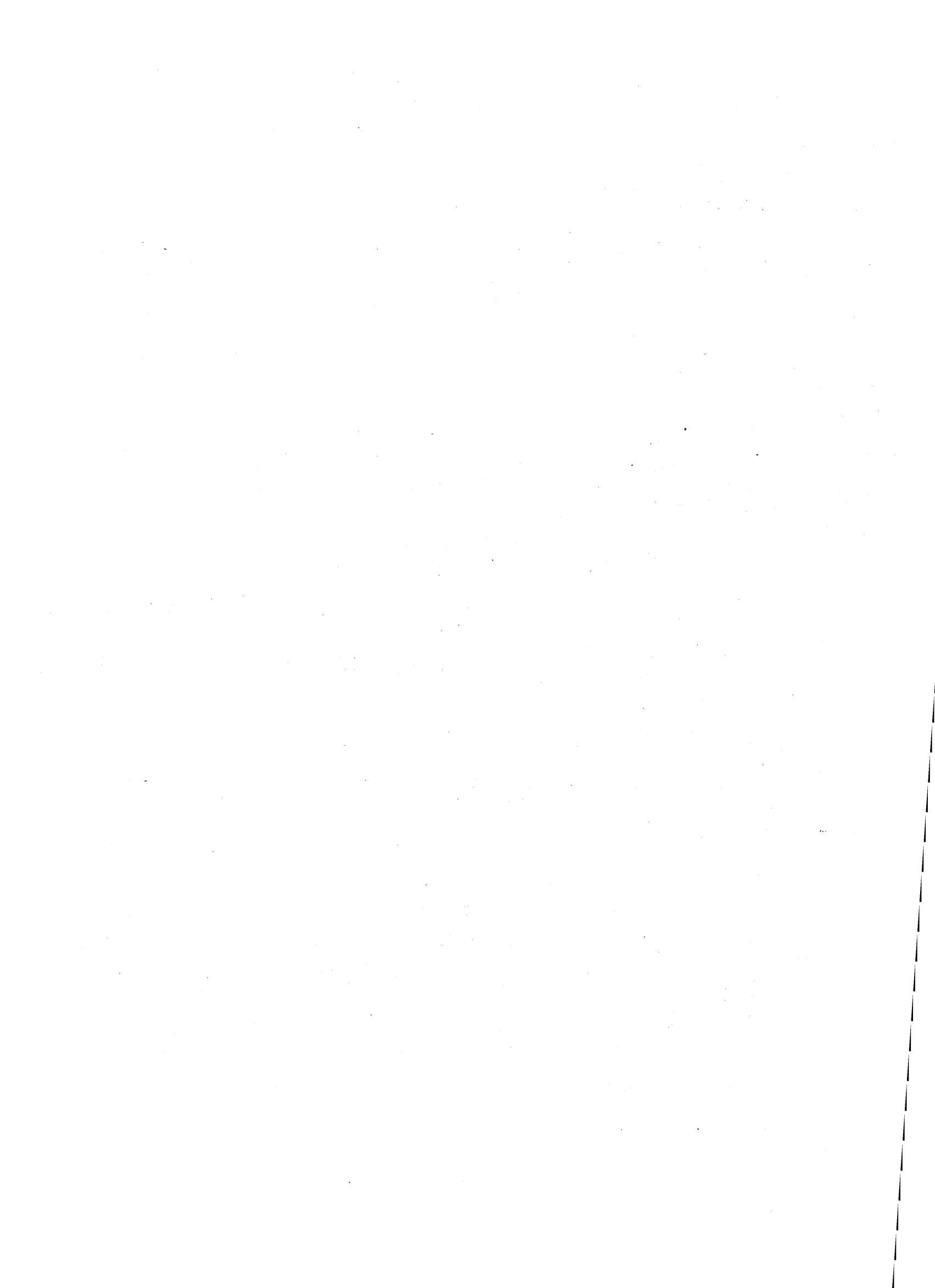

February 8, 1903.

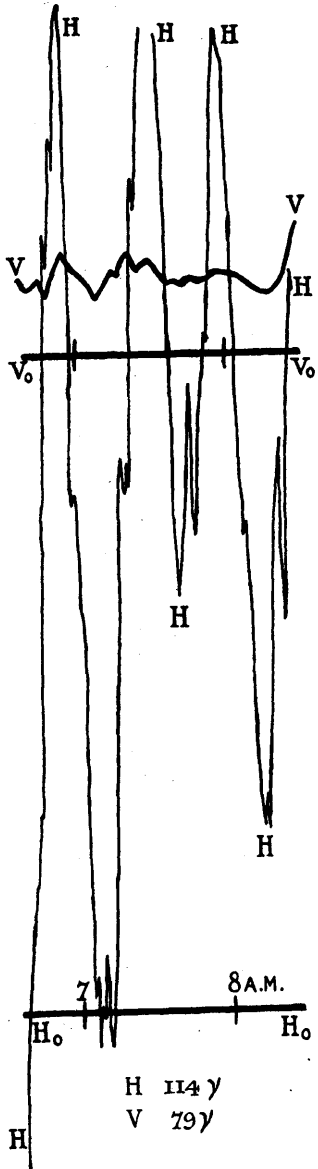

February 10, 1903.

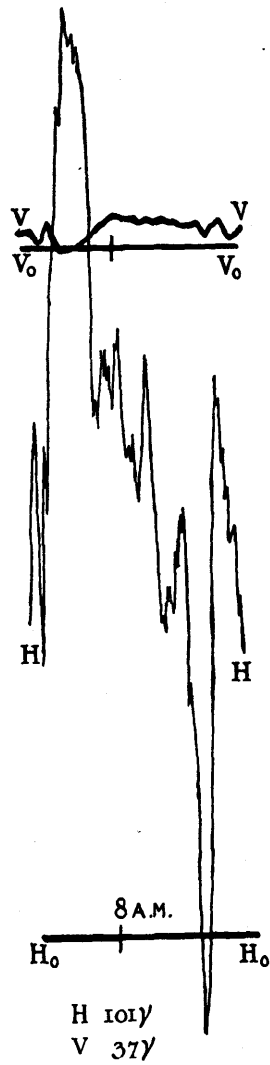

March 6, 1903.

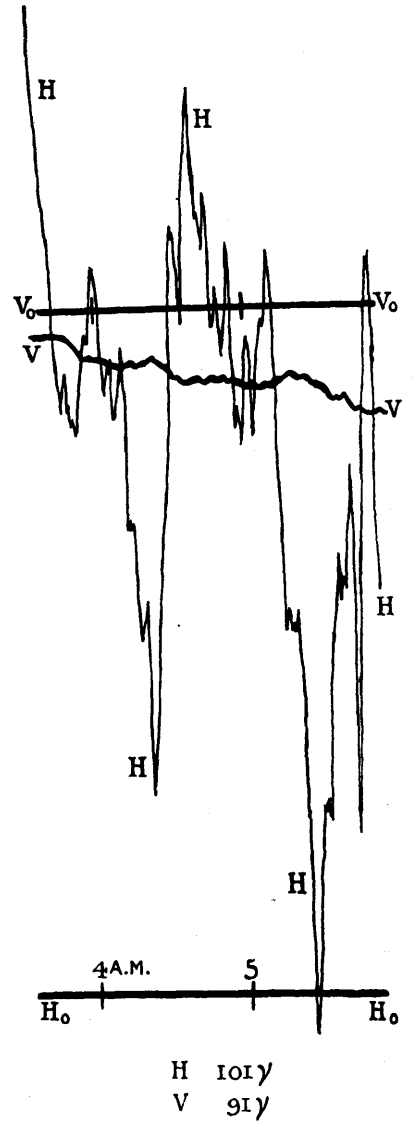

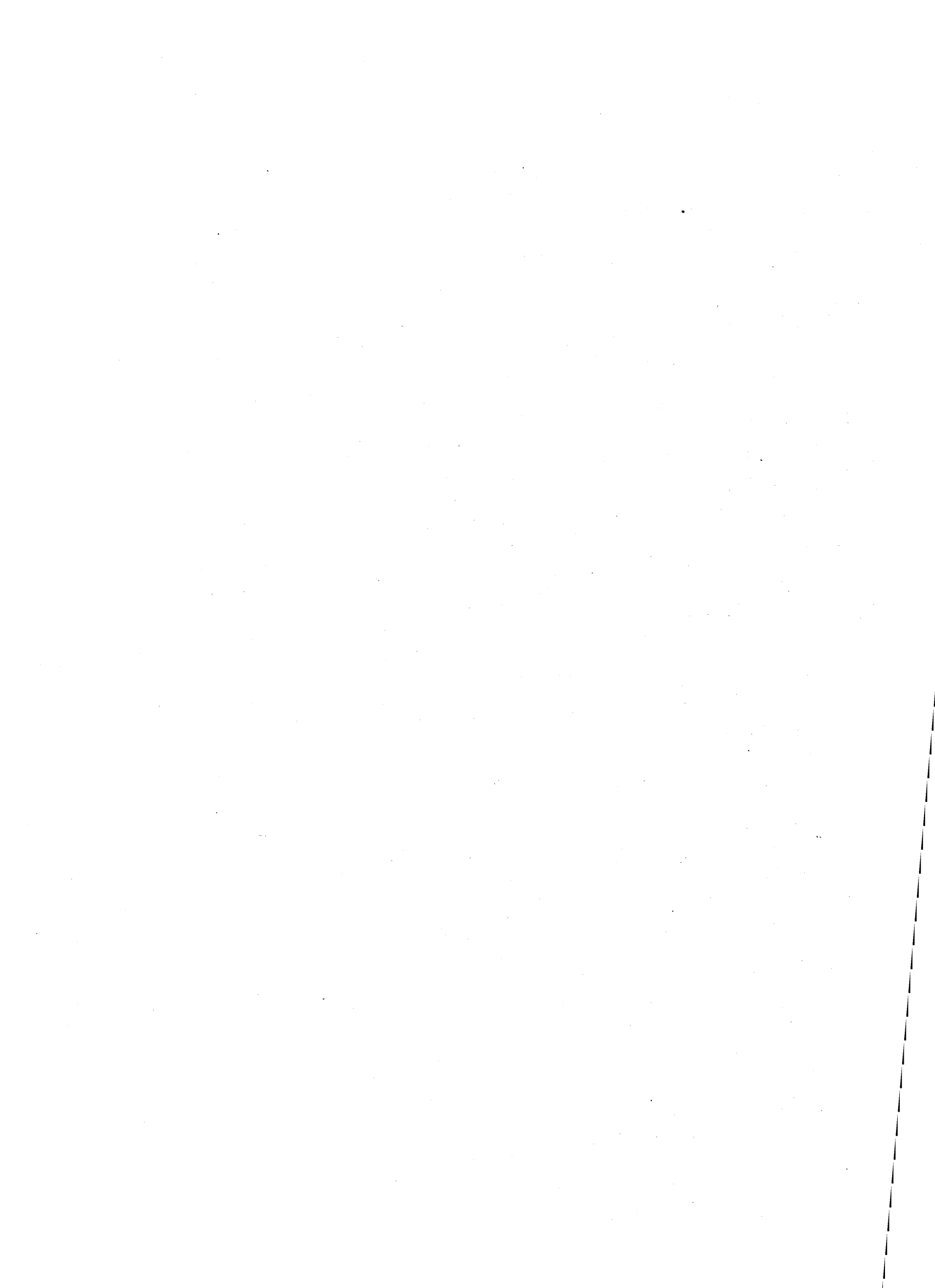



Feb. 25, 1903.

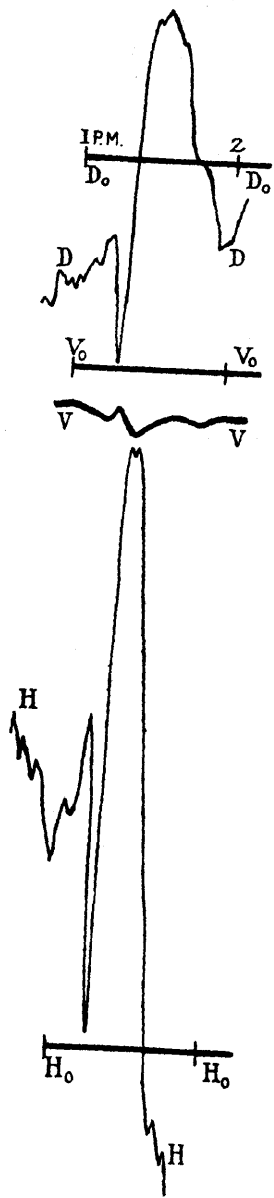

D 1°9'  
H 73γ  
V 33γ

Feb. 26, 1903.

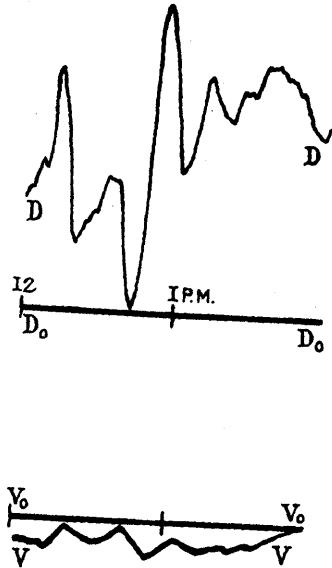

D 1°0'  
H 51γ  
V 29γ

April 1, 1903.

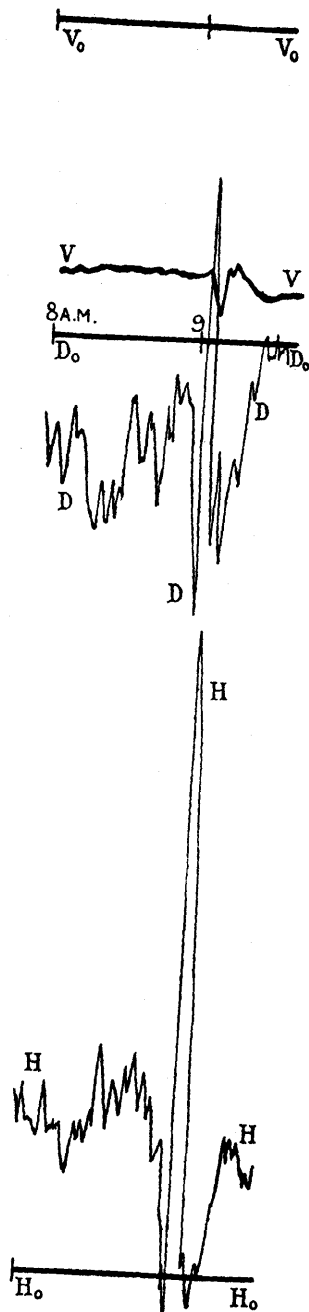

D 1°27'  
H 90γ  
V 105γ

June 10, 1903.

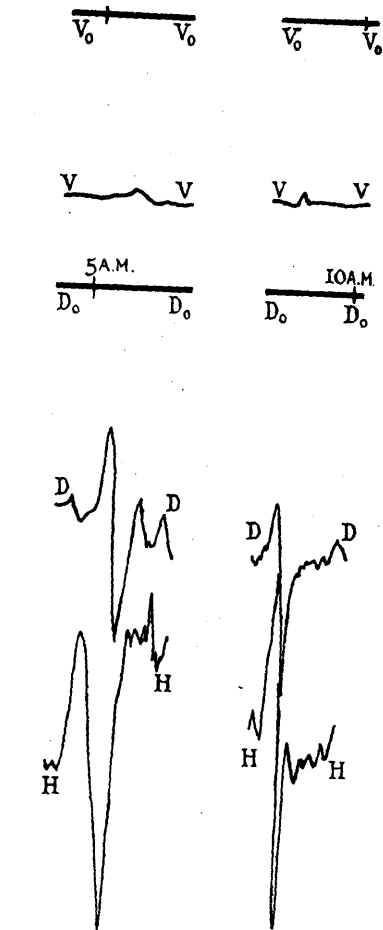

D 42'  
H 45γ  
V 29γ

D 38'  
H 47γ  
V 29γ

Aug. 12, 1903.

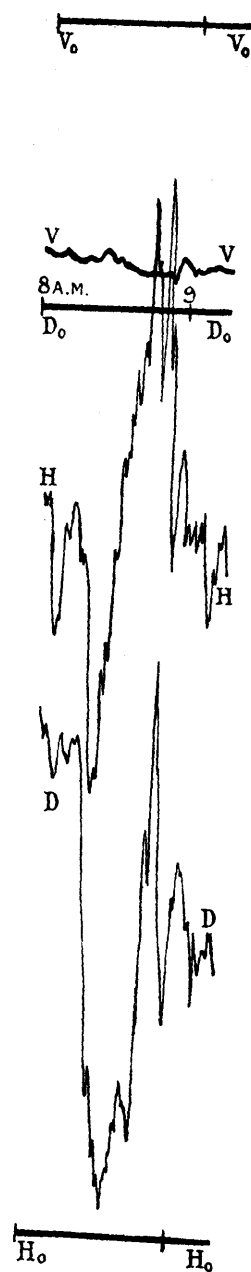

D 1°48'  
H 82γ  
V 62γ



August 15, 1903.

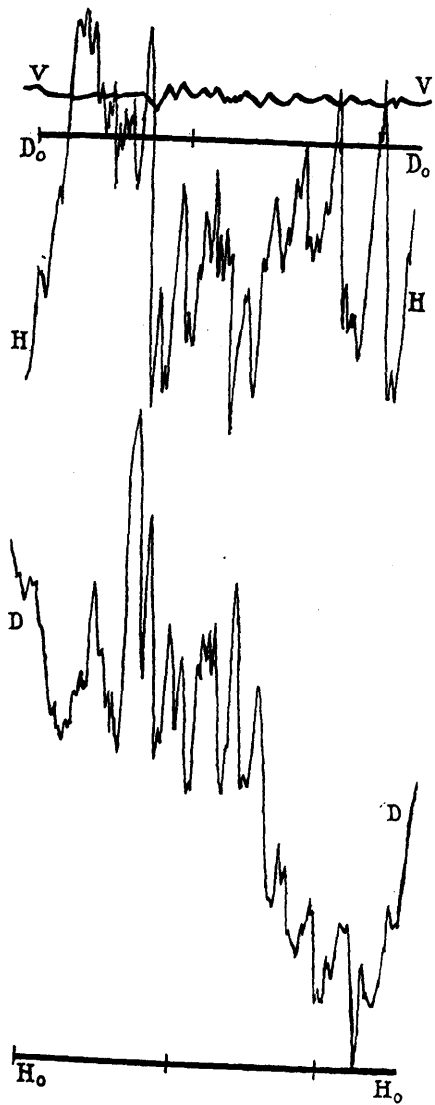
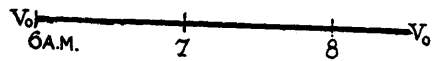

D 2° 9'; H 56γ; V 57γ.

September 6, 1903.

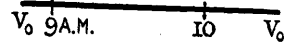

D 1° 14'; H 61γ; V 45γ.

November 6, 1903.

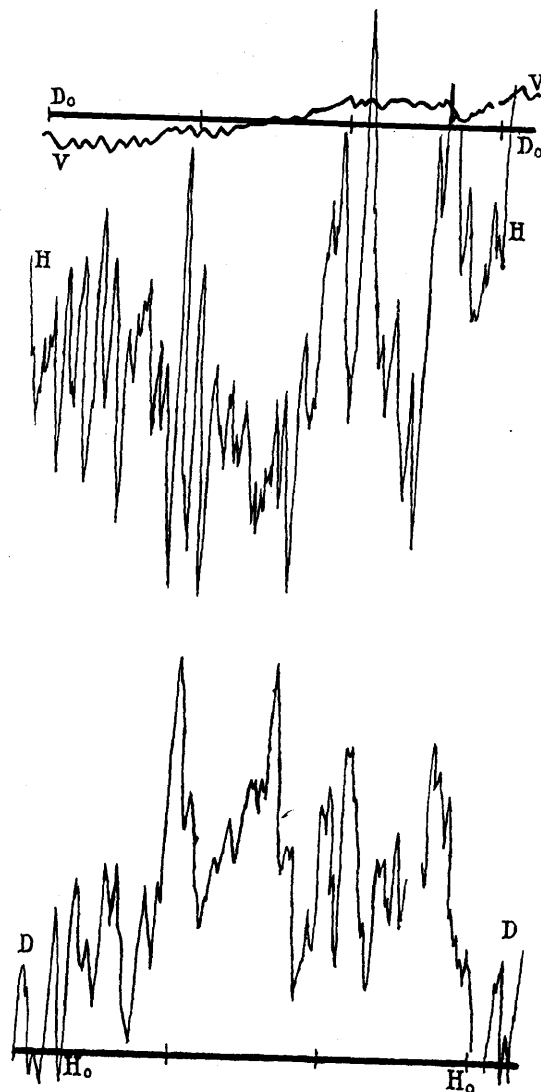
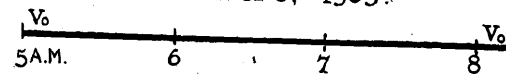

D 1° 24'; H 78γ; V 154γ.



